



Plastic/ Oral

1	Scissors	03
2	Needle Holders	04
3	Forceps	05
4	Raspatories and Elevators	06
5	Raspatories	07-08
6	Spring Forceps, Hooks and Picks	09
7	Retractors	10-11
8	Osteotomes, Chisels and Gouges	12
9	Miscellaneous	13-14

Kilner Scissors

Rounded blades, 115mm long

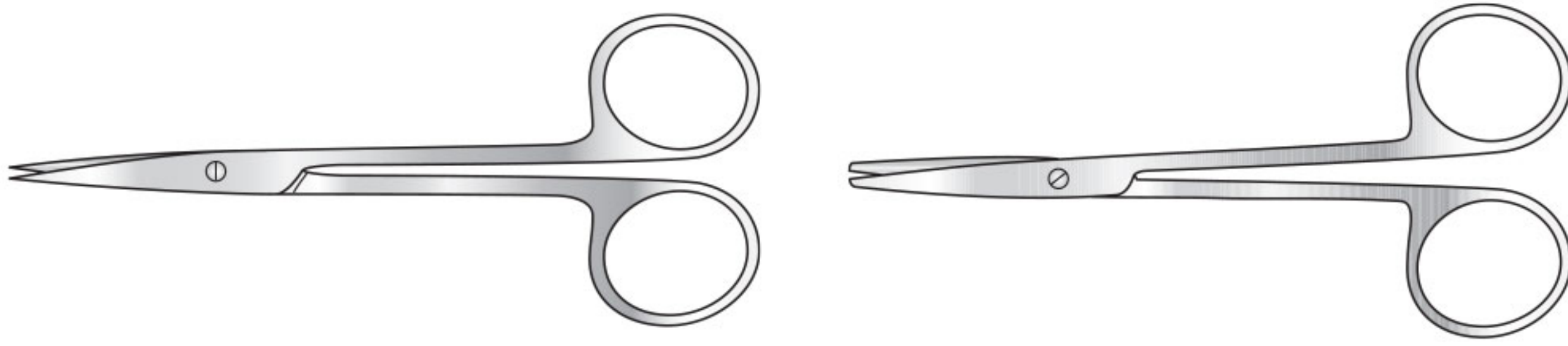

Code	Description
FST-5-101	Straight, sharp points
FST-5-102	Curved, blunt points

Aufricht Dissecting Scissors

Heavy pattern, triangular blades, 140mm long

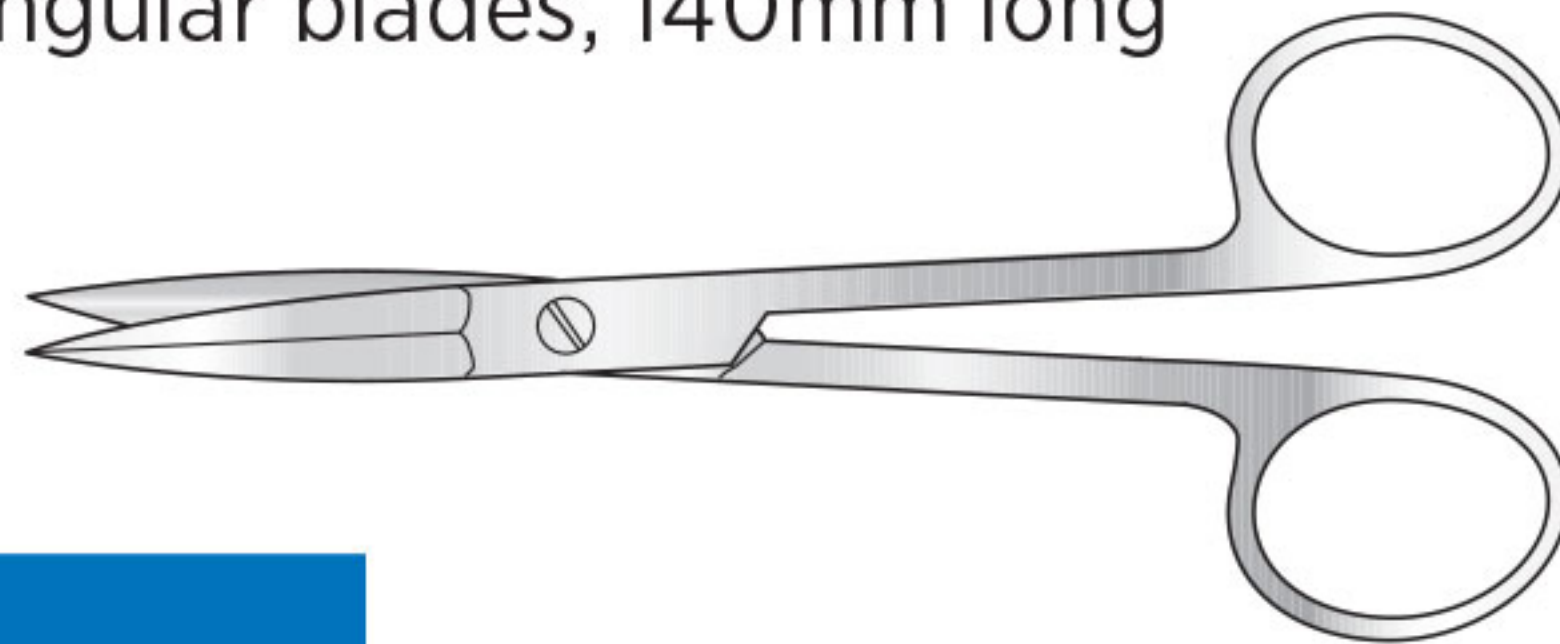

Code	Description
FST-5-104	Straight
FST-5-105	Curved

Aufricht Dissecting Scissors

Light pattern, 150mm long

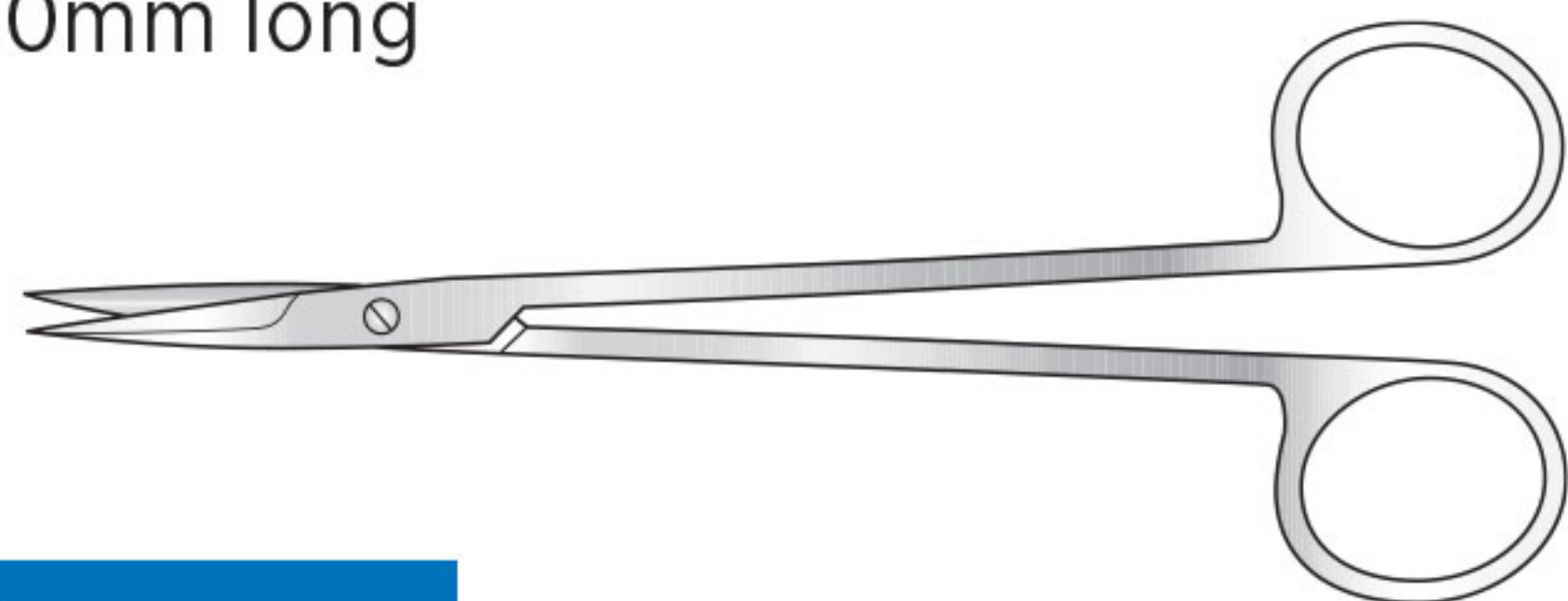

Code	Description
FST-5-110	Straight
FST-5-111	Curved

Scissors

Curved, sharp points

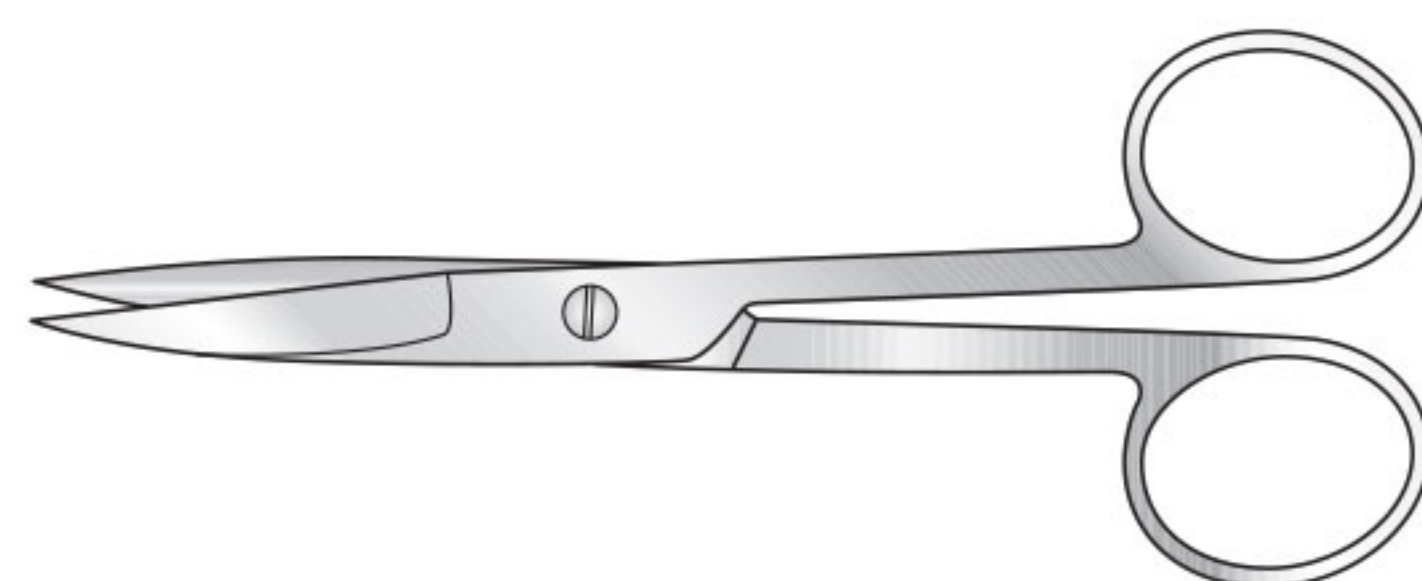

Code	Description
FST-5-113	130mm long

Scissors

Angular, for cutting cartilage, wire cutting notch

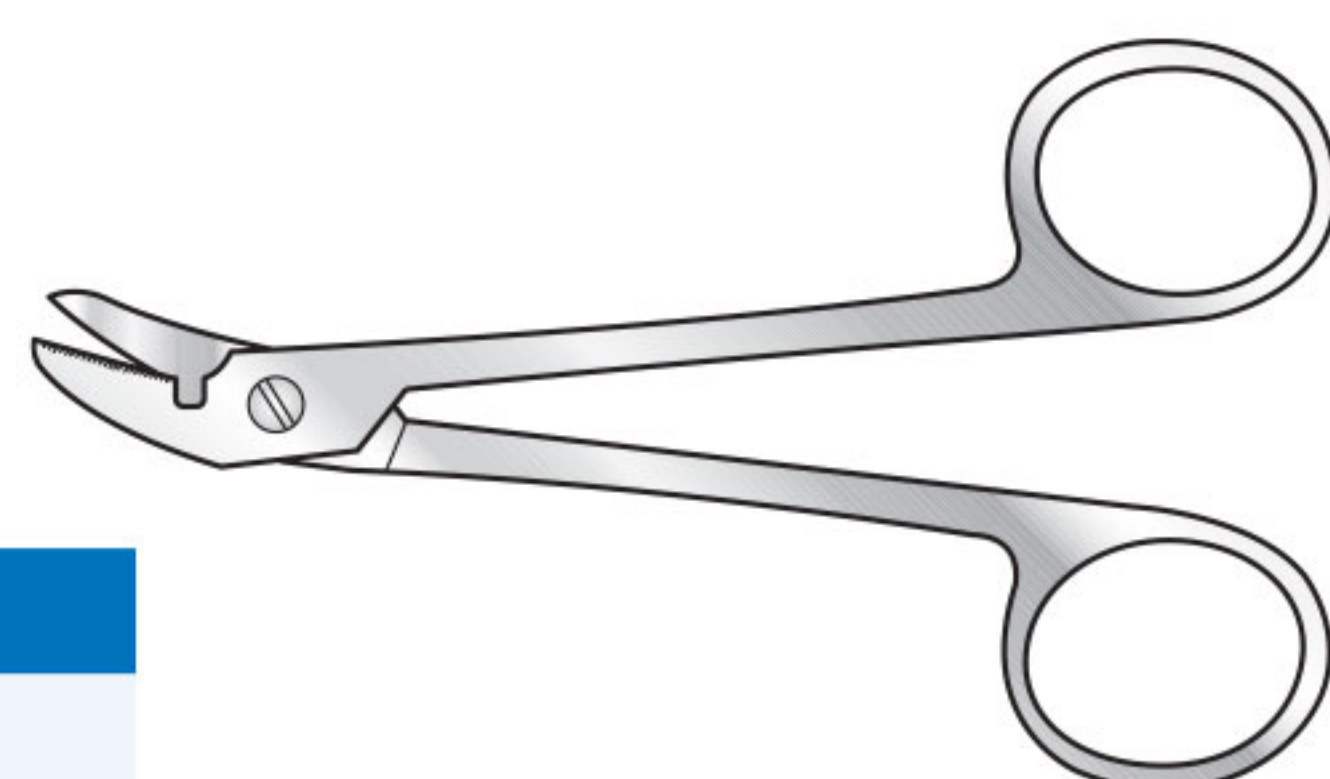

Code	Description
FST-5-117	127mm long

McIndoe Scissors

Curved on flat, round tapering ends

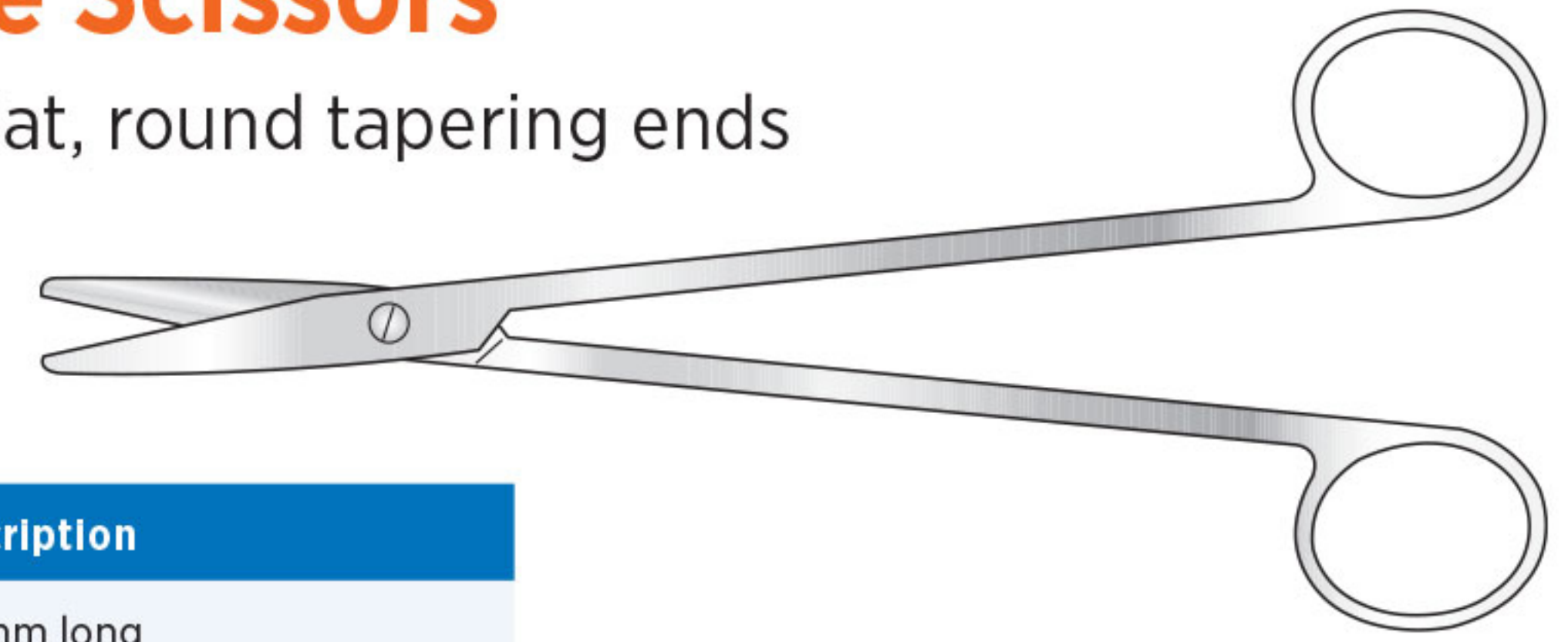

Code	Description
FST-5-103	190mm long

Stevens Tenotomy Scissors

Supercut, 114mm long

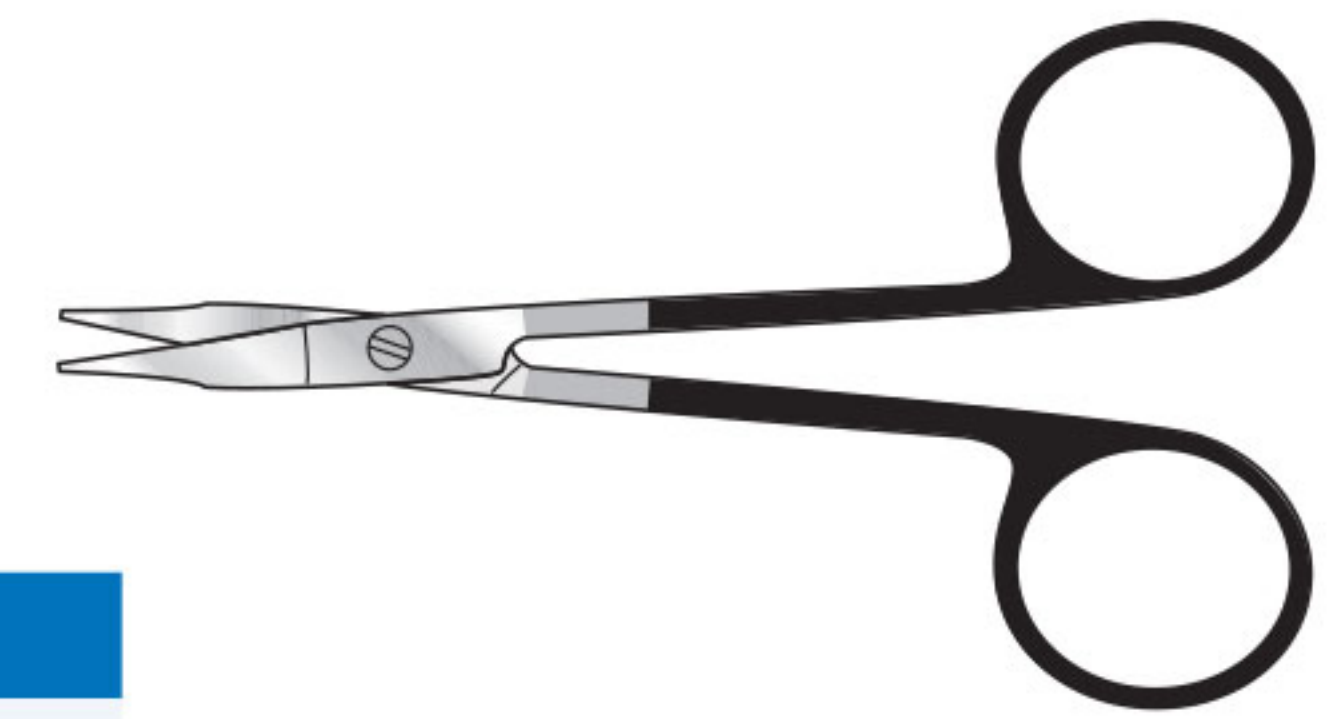

Code	Description
FST-5-106	Curved/blunt
FST-5-107	Curved/sharp
FST-5-108	Straight/blunt
FST-5-109	Straight/sharp

Cartilage Cutting Scissors

Fine points, serrated edges

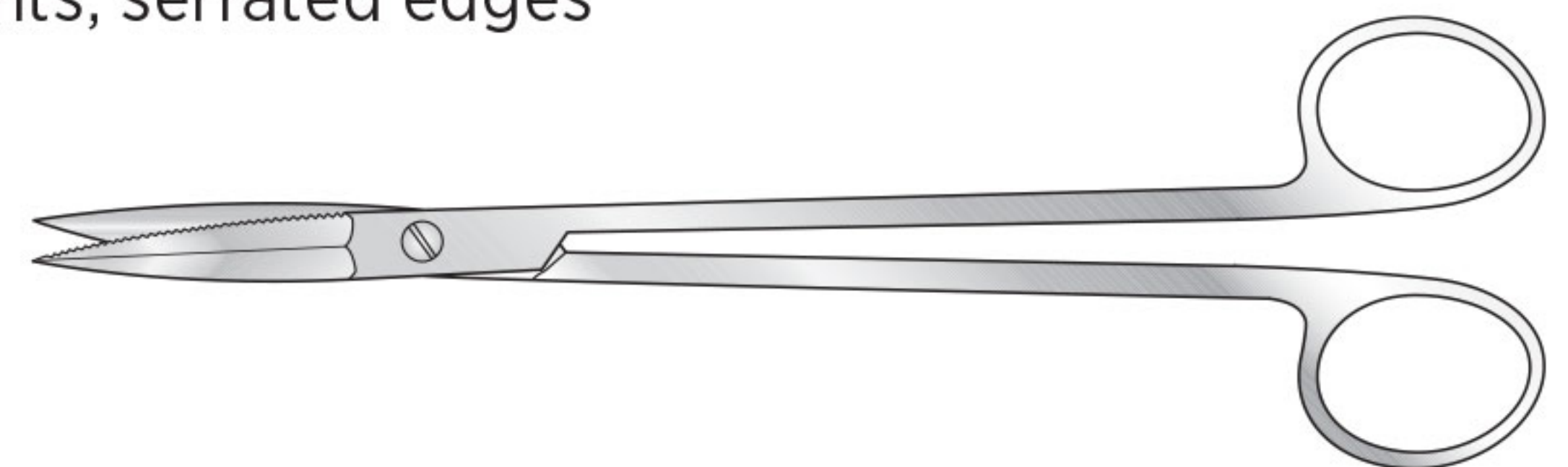

Code	Description
FST-5-112	190mm long

Gorney Supercut Scissors

Rhytidectomy scissor, tungsten carbide, one micro serrated and one razor sharp edge

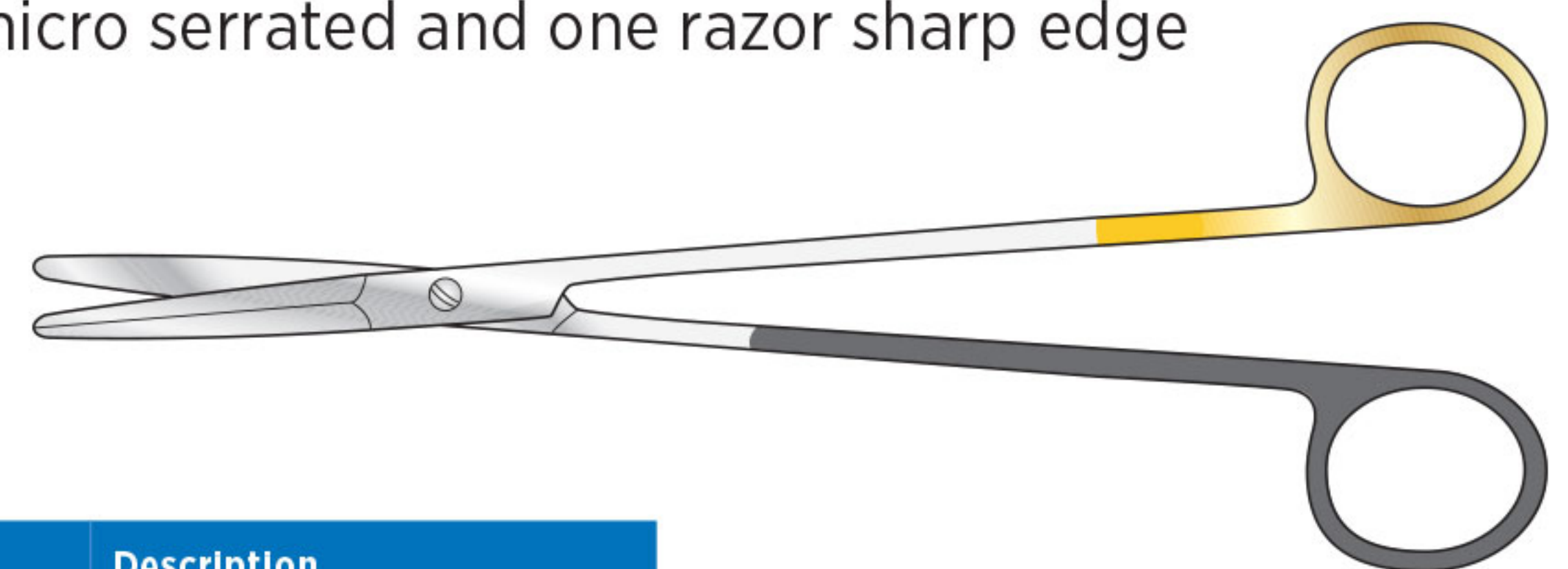

Code	Description
FST-5-114	125mm long
FST-5-115	200mm long, straight
FST-5-116	200mm long, curved

Fickling (Cathcart) Scissors

Angled

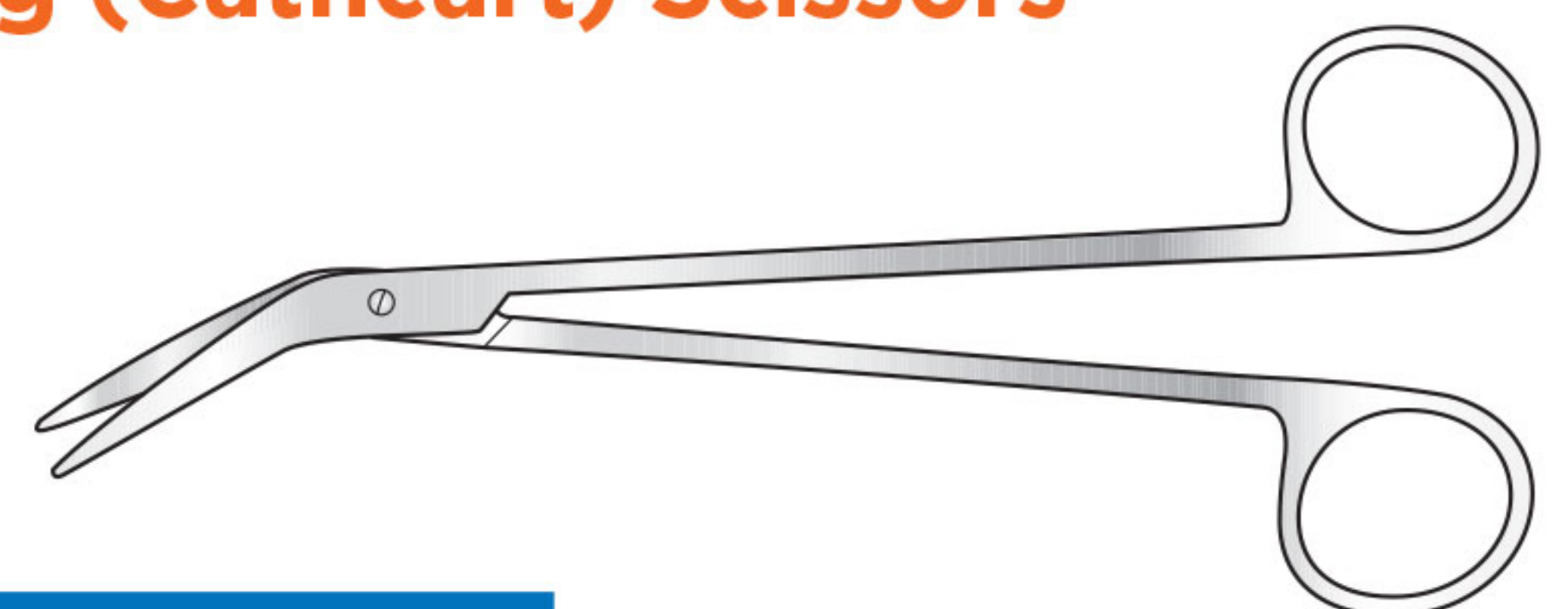

Code	Description
FST-5-118	180mm long

Needle Holders

Foster Scissor/Needle Holder

Fenestrated jaw, 125mm long

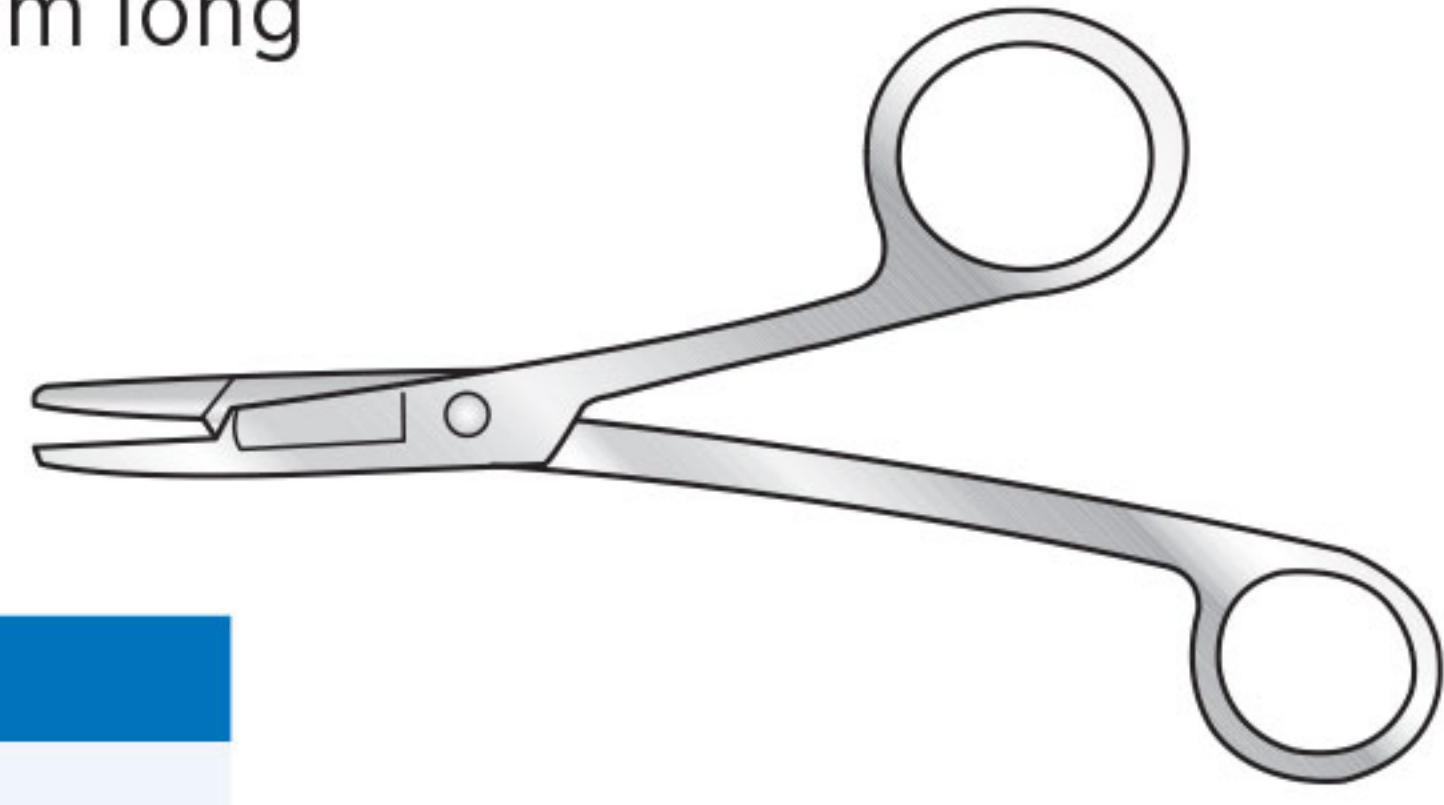

Code	Description
FST-5-130	Left

Lawrence Needle Holder

Fine jaw, 150mm long

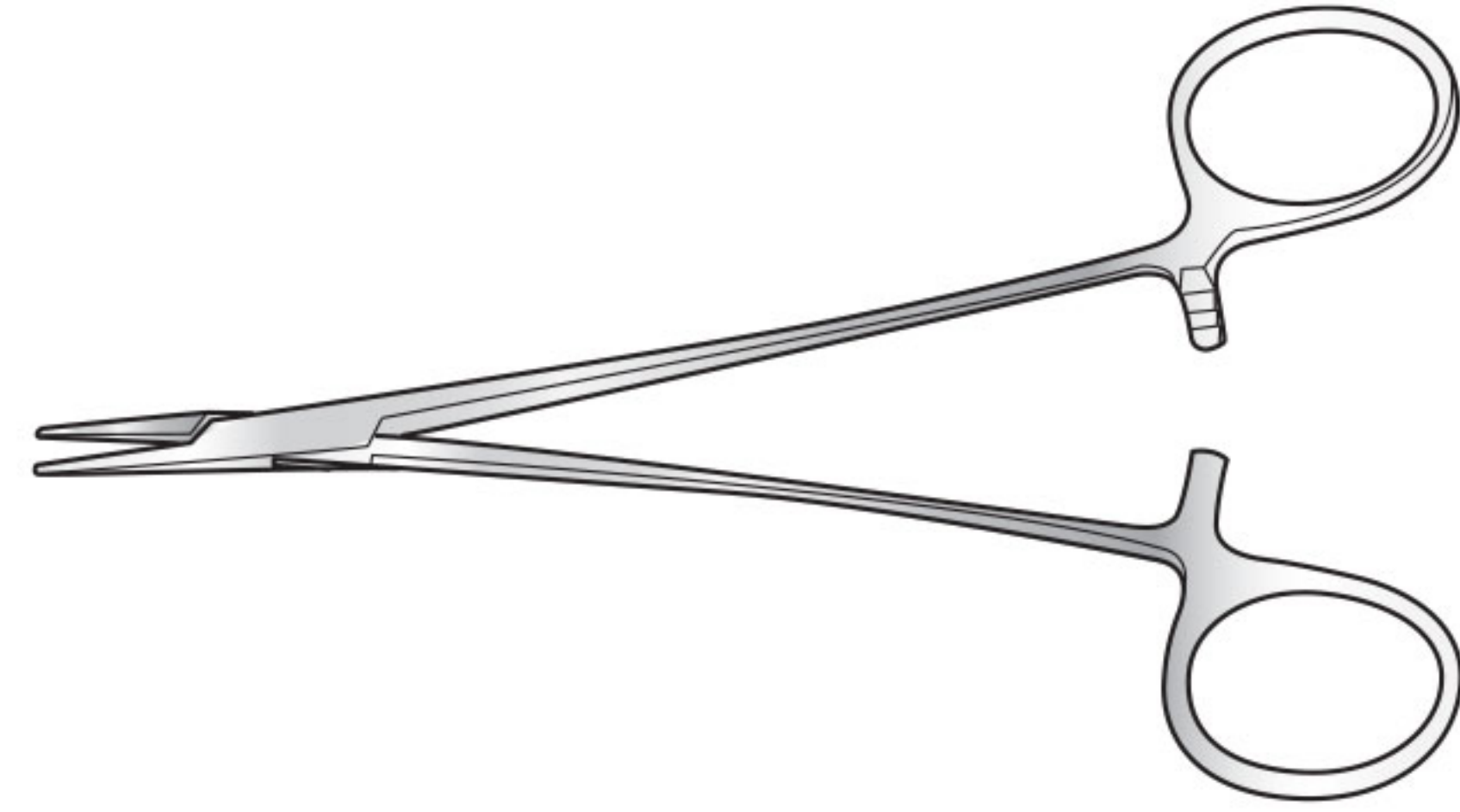

Code	Description
FST-5-131	
FST-5-132	Tungsten carbide, with two gold bows

Derf Needle Holder

Tungsten carbide insert, with two gold bows



Code	Description
FST-5-133	115mm long
FST-5-134	125mm long

Reverdin Suture Needle

With automatic eye, 203mm long

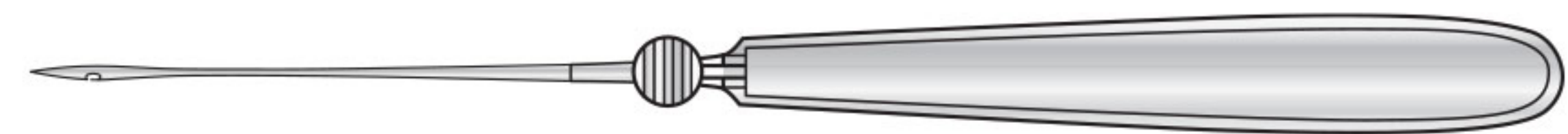

Code	Description
FST-5-136	Fully curved
FST-5-137	Curved
FST-5-138	Slightly curved
FST-5-139	Straight

Masing Needle Holder

Tungsten carbide insert, one angled bow

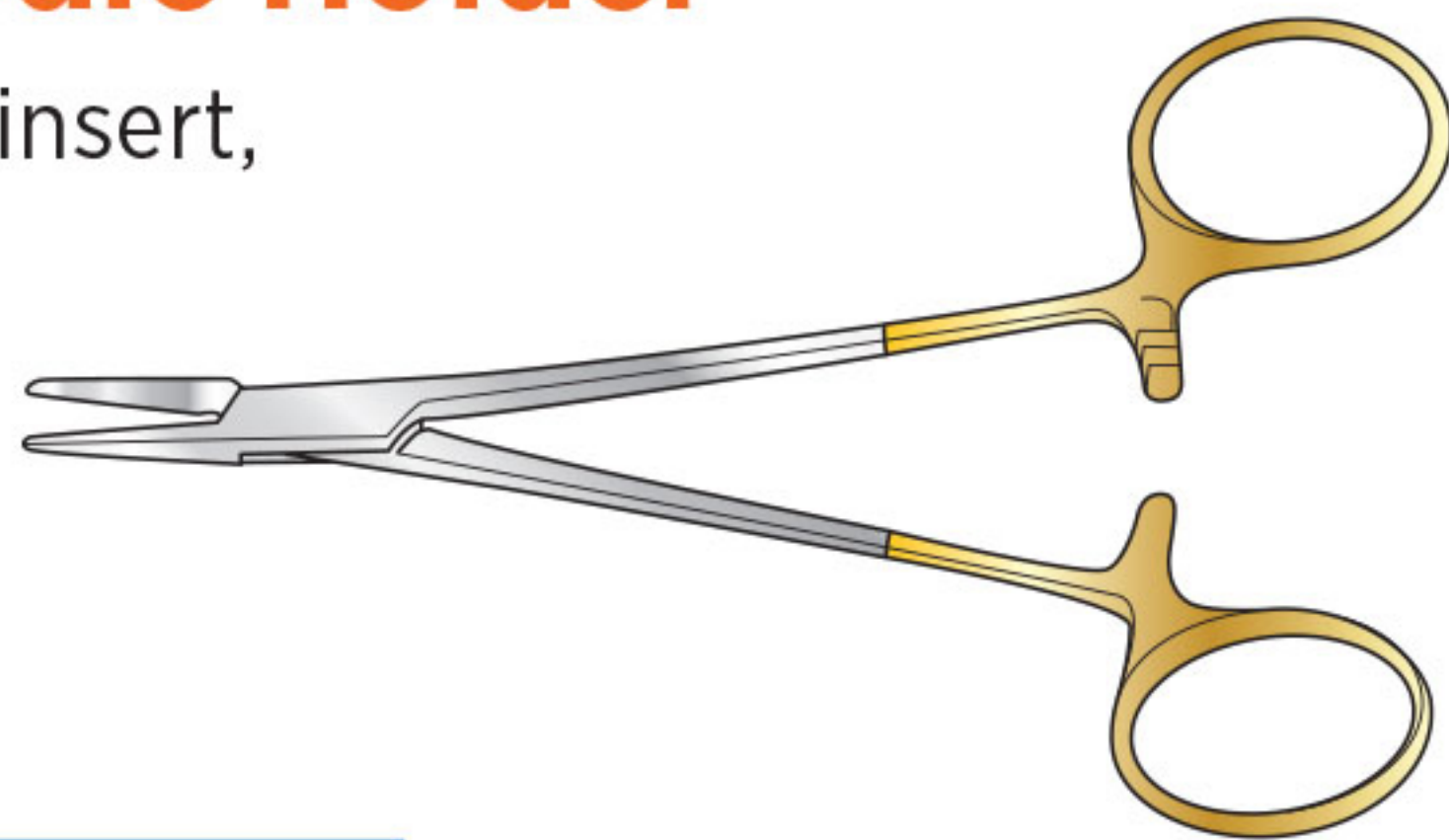

Code	Description
FST-5-135	130mm long

Castroviejo Needle Holder

Code	Description
FST-5-140	140mm long, with catch
FST-5-141	140mm long, without catch

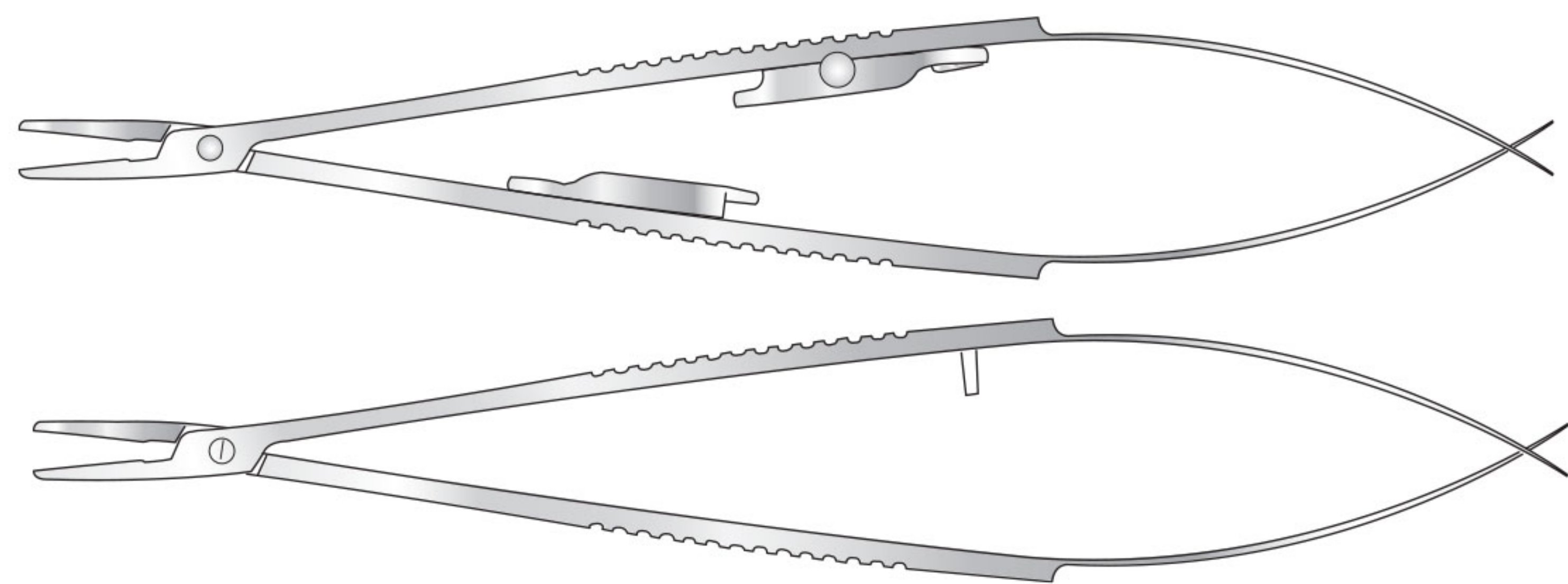

Diamond dust jaws

Code	Description
FST-5-142	180mm long, without catch
FST-5-143	200mm long, without catch
FST-5-144	215mm long, without catch

ALSO AVAILABLE WITH CATCH - ADD SUFFIX CTH TO CODE

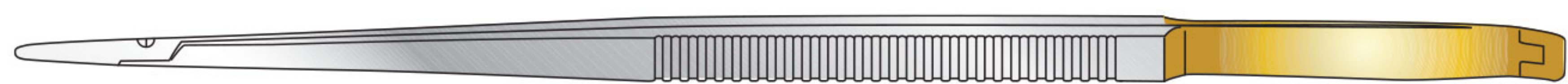

Tungsten carbide jaws

Code	Description
FST-5-145	180mm long
FST-5-146	200mm long
FST-5-147	215mm long

ALSO AVAILABLE WITH CATCH - ADD SUFFIX CTH TO CODE

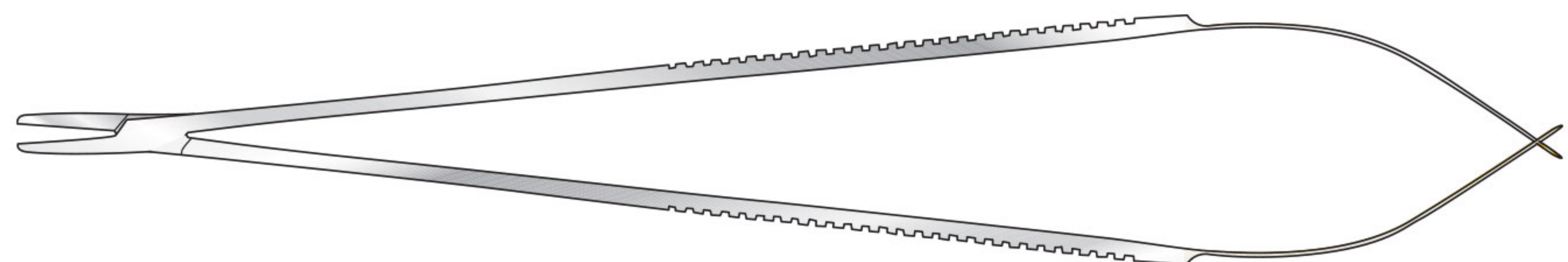

Mustarde Suture Holding Forceps

Convex and concave jaw

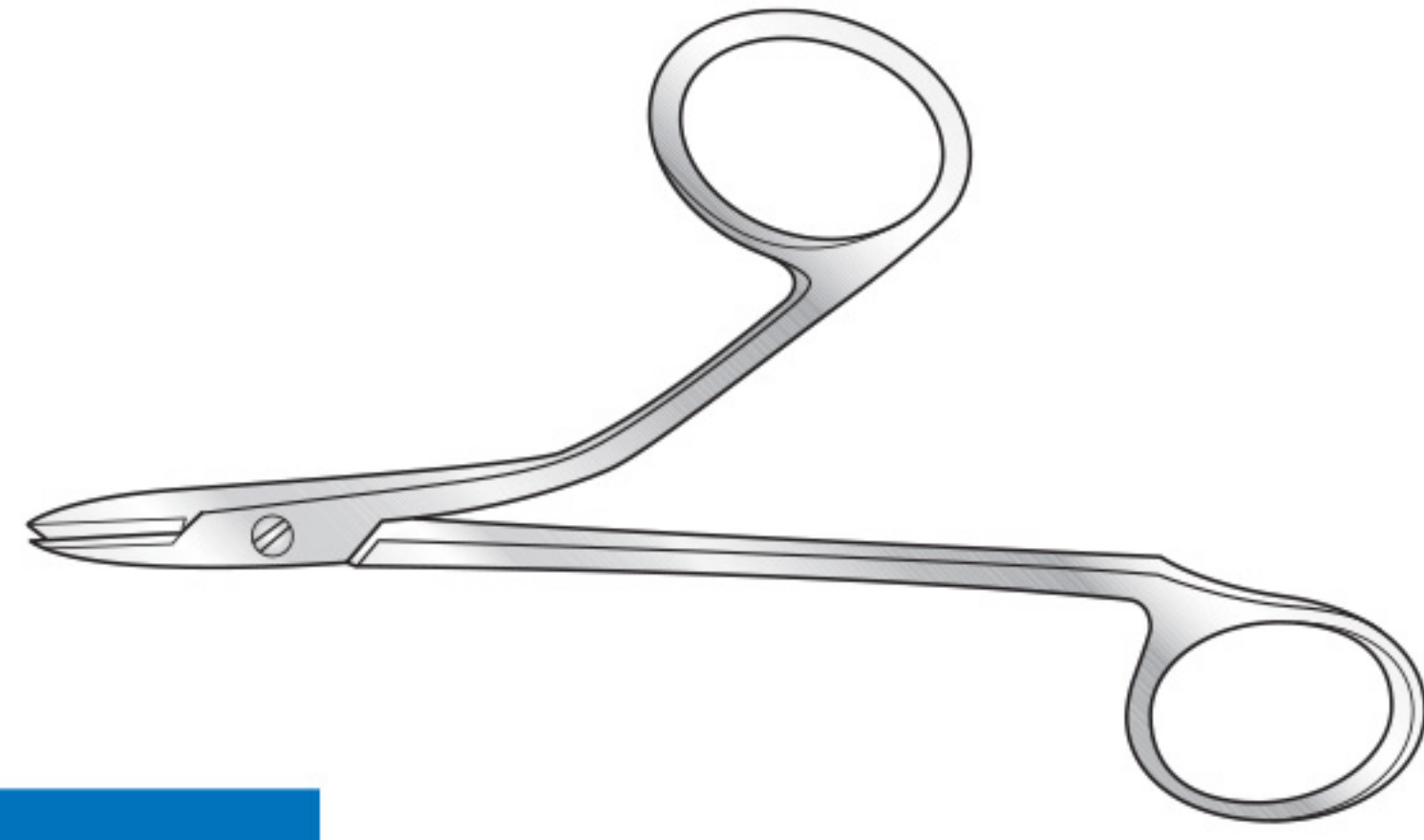

Code	Description
FST-5-160	133mm long

Walsham Septum Straightening Forceps

220mm long

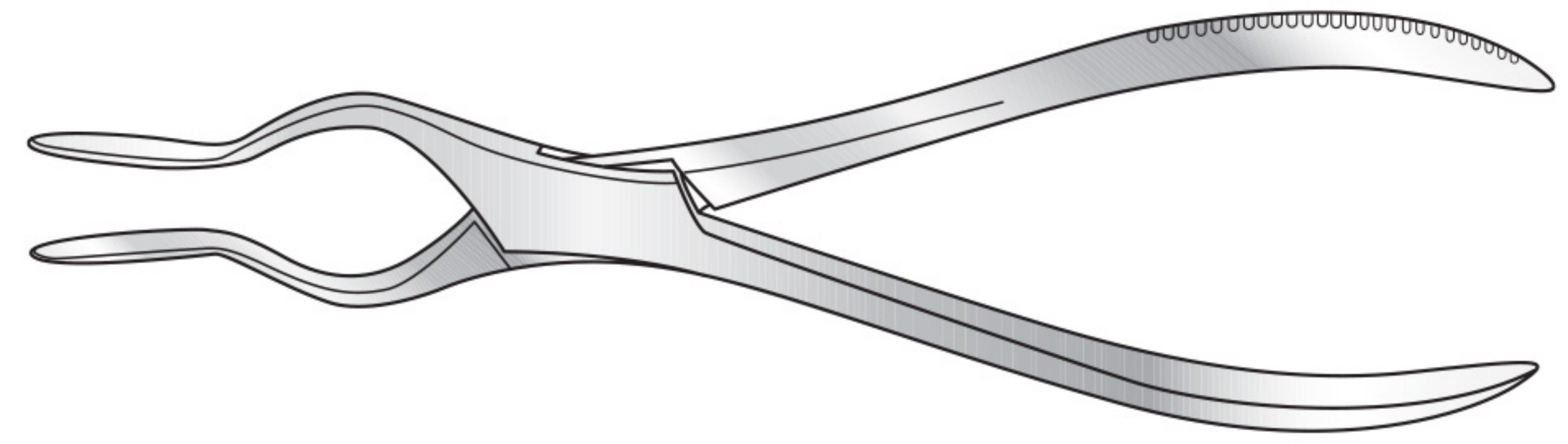

Code	Description
FST-5-161	Straight
FST-5-162	Right
FST-5-163	Left

Fickling Artery Forceps

190mm long

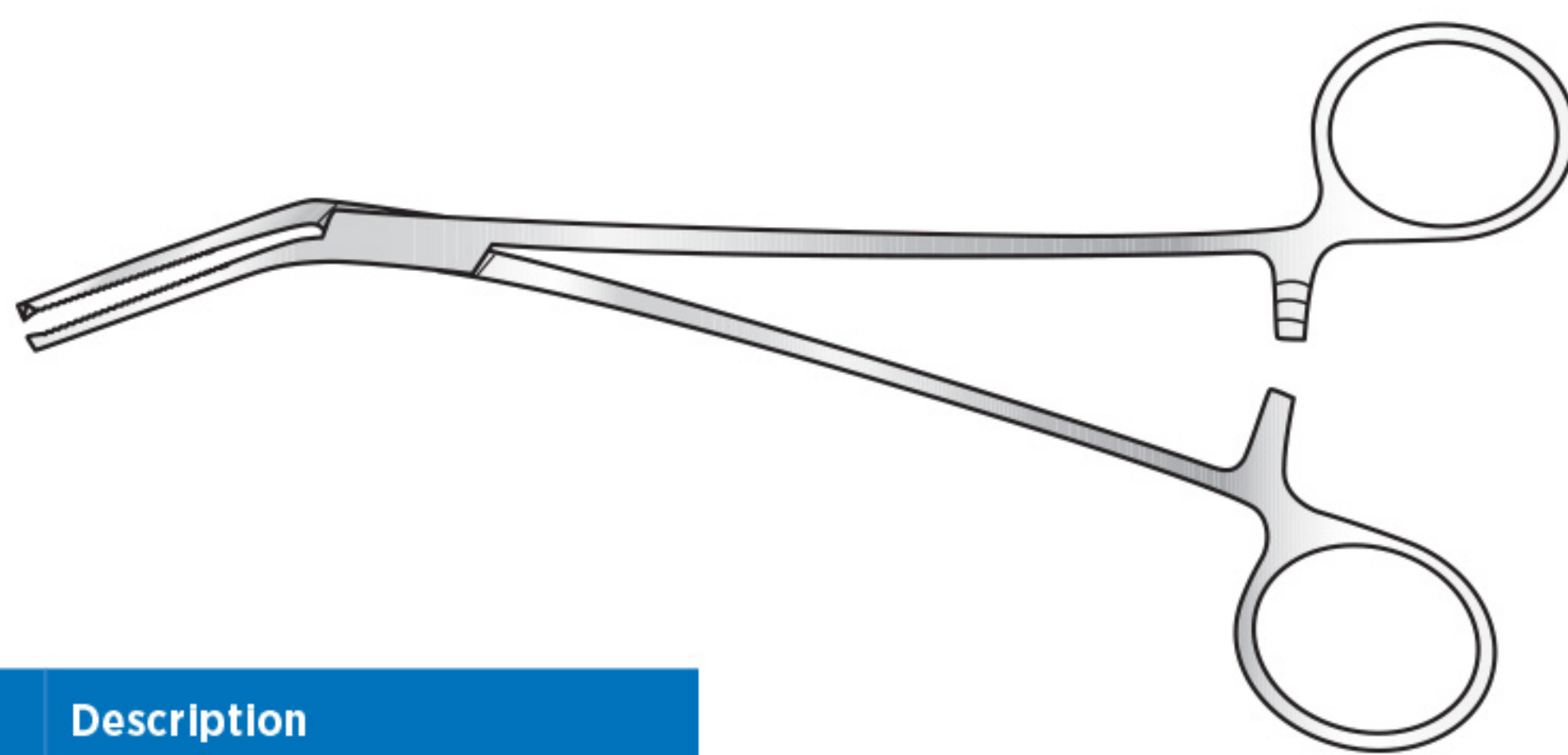

Code	Description
FST-5-164	Serrated
FST-5-165	1-2 teeth

Bone Cutting Forceps

Straight, compound action

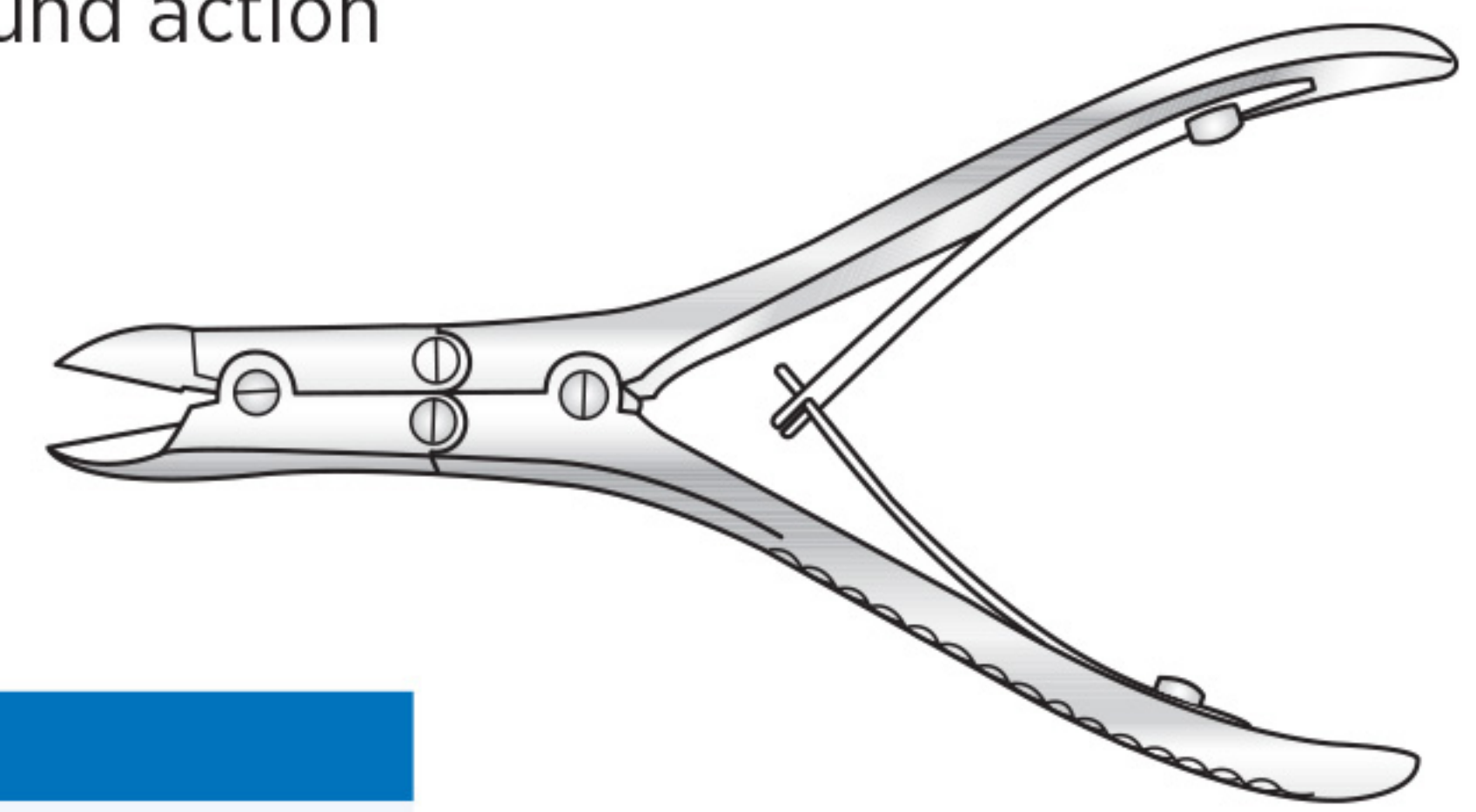

Code	Description
FST-5-166	146mm long

Asch Septum Forceps

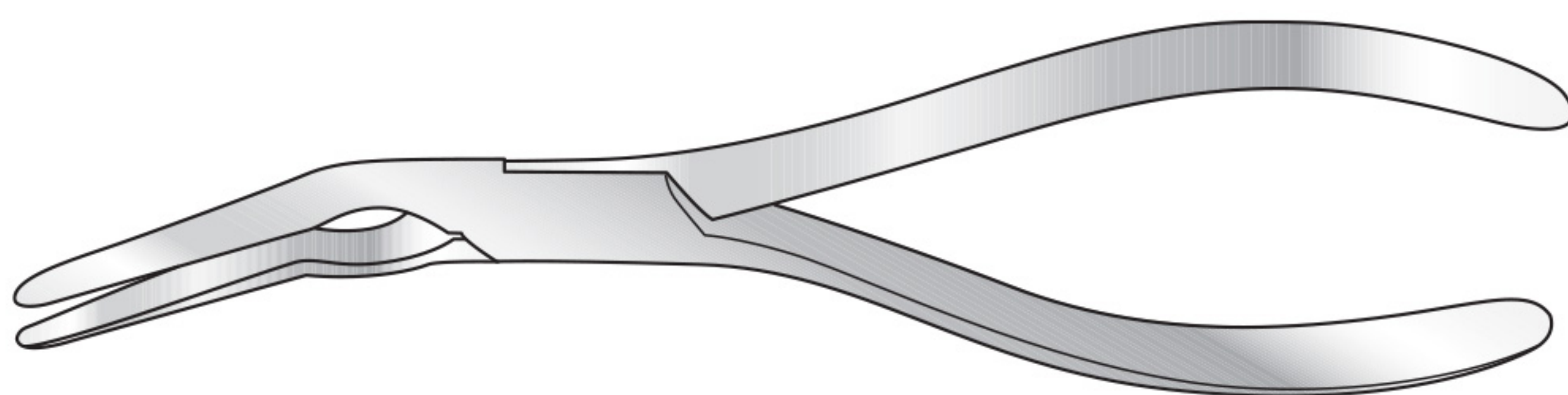

Code	Description
FST-5-167	235mm long

Ward Bone Cutting Forceps

Slightly angled on flat

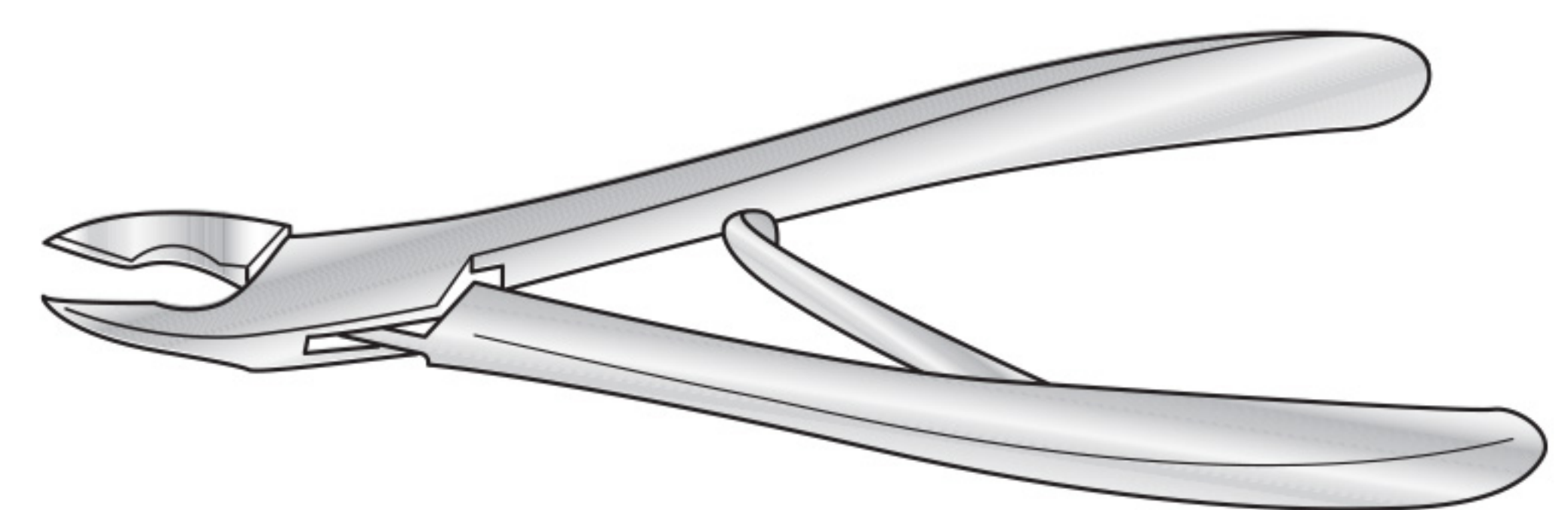

Code	Description
FST-5-168	178mm long

Jansen-Middleton Septum Forceps

Compound action, 178mm long

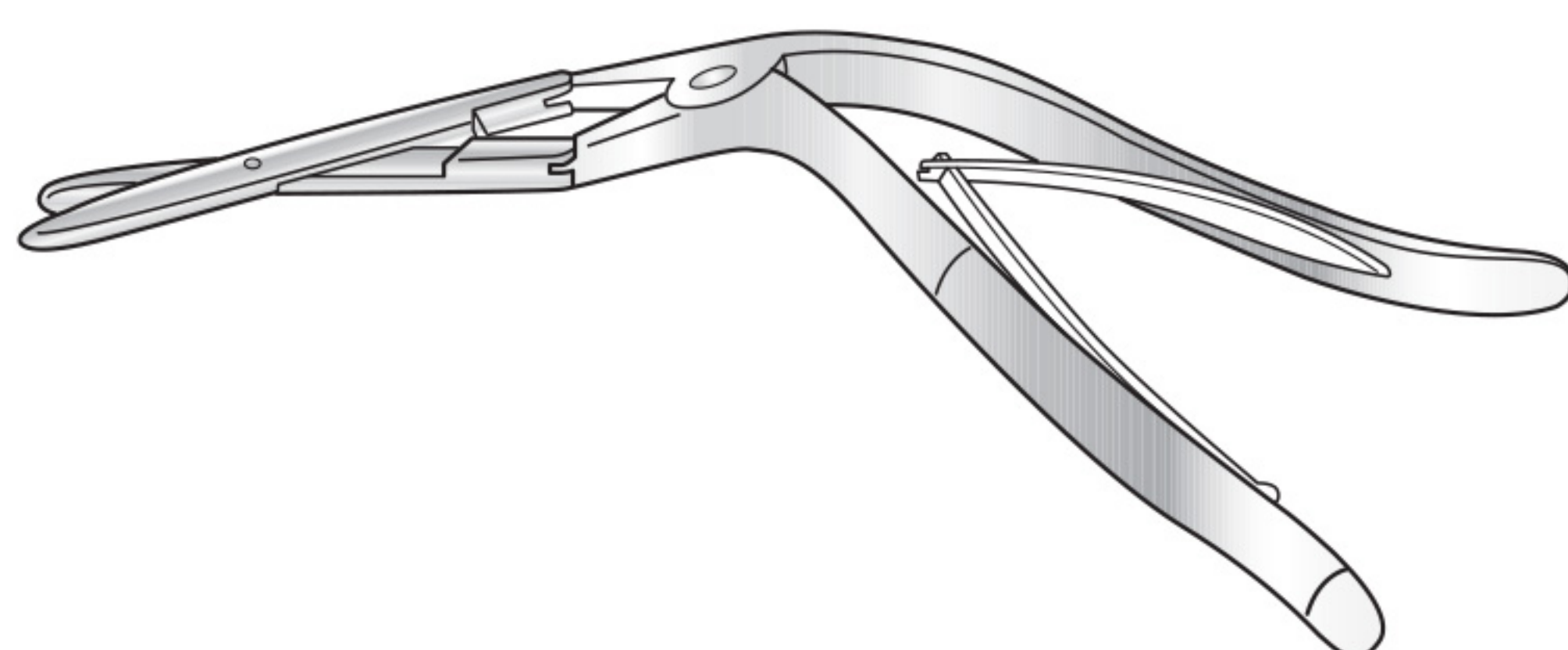

Code	Description
FST-5-169	5mm bite

Raspatories and Elevators

Cleft Palette Raspatory



Code	Description
FST-5-180	Curved downwards
FST-5-181	Curved upwards

Cleft Palette Raspatory

Curved upwards

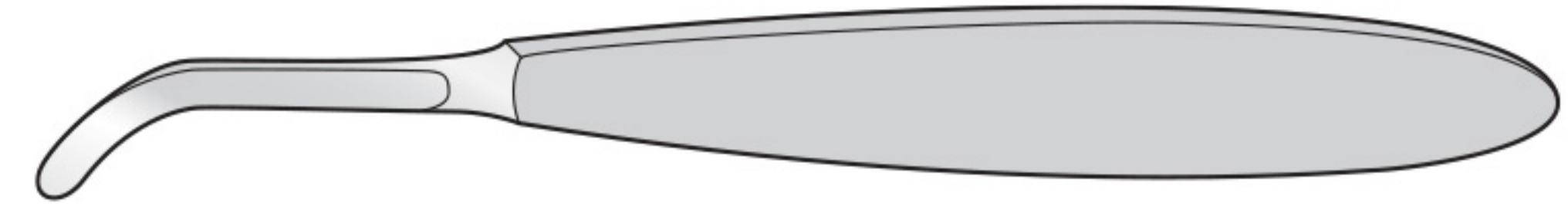

Code	Description
FST-5-182	Left
FST-5-183	Right

McIndoe Raspatory

For cleft palette, spoon end, 170mm long



Code	Description
FST-5-184	Small
FST-5-185	Medium
FST-5-186	Large

Farabeuf Elevator

Light, 160mm long

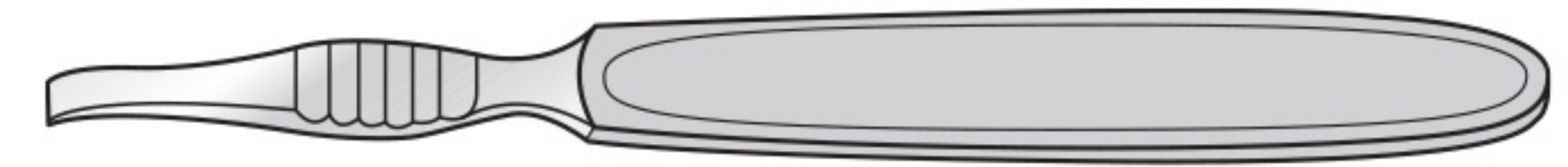

Code	Description
FST-5-187	12mm curved
FST-5-188	8mm curved

Howarth Elevator



Code	Description
FST-5-189	220mm long

Syme Periosteal Elevator

Double ended



Code	Description
FST-5-190	170mm long

Cryer Elevator

150mm long

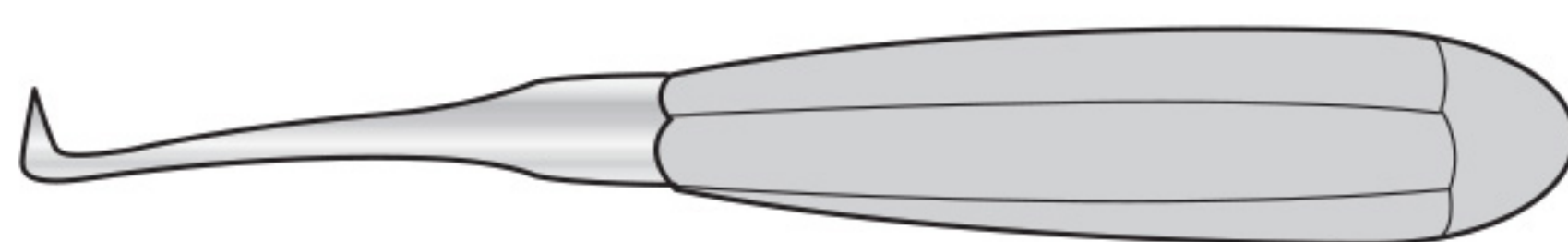

Code	Description
FST-5-191	Right
FST-5-192	Left

Coupland Elevator

Curved, 150mm long

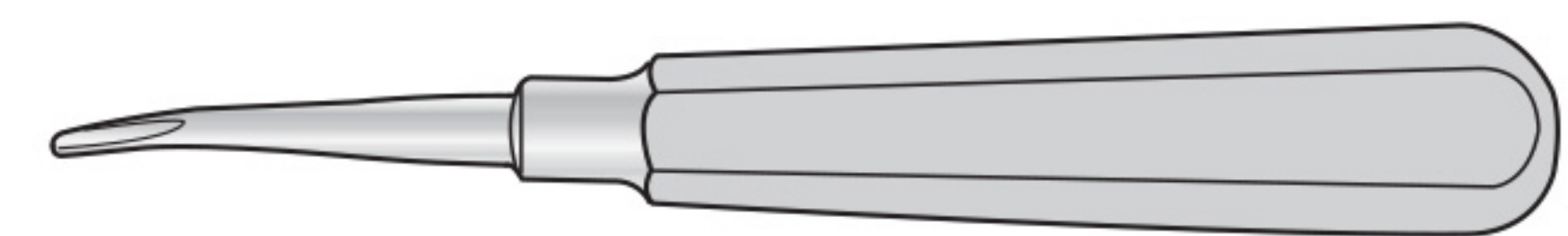

Code	Description
FST-5-193	3mm wide
FST-5-194	3.5mm wide
FST-5-195	4mm wide

Aufricht Raspatory

9mm wide, 220mm long

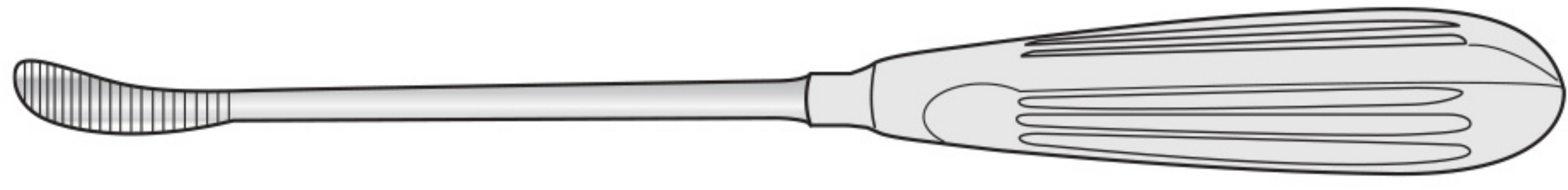

Code	Description
FST-5-201	Up stroke
FST-5-202	Down stroke

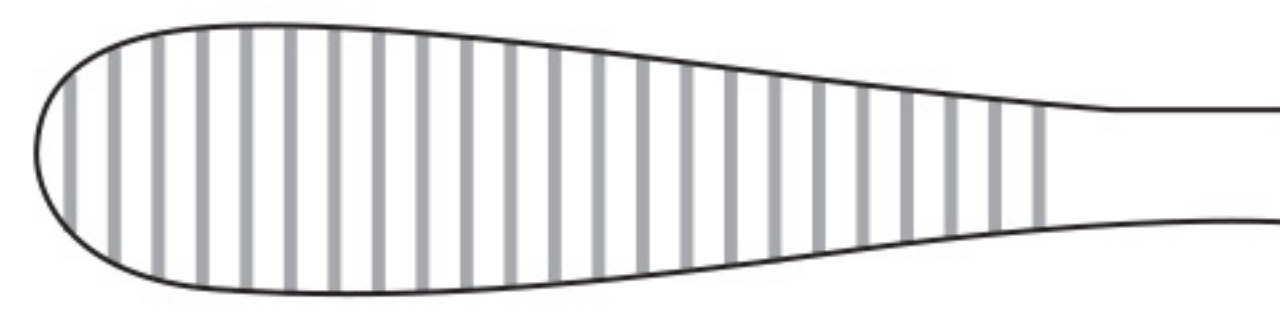

Durogrip Raspatory

7mm wide, 205mm long

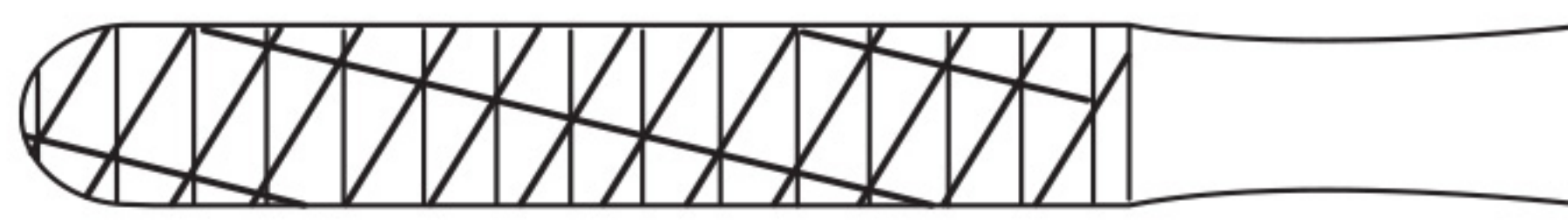

12/14 teeth

Code	Description
FST-5-204	12/14 teeth
FST-5-205	16/20 teeth
FST-5-206	24/30 teeth
FST-5-207	36/44 teeth
FST-5-208	52/62 teeth

Fomon Raspatory

6.5 and 7.5mm wide, 215mm long

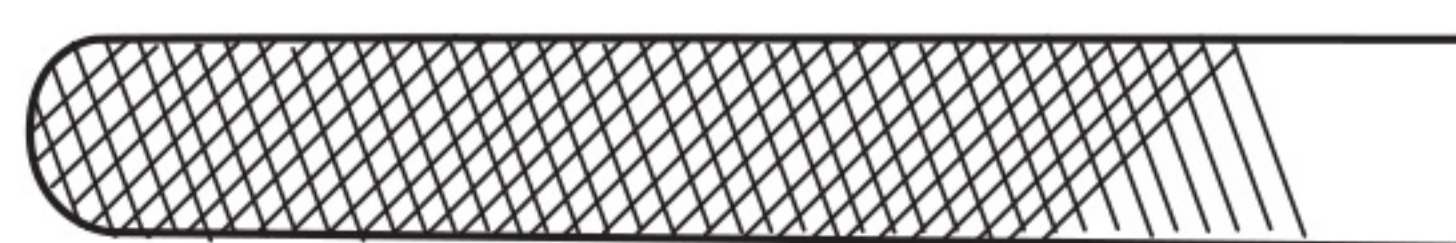
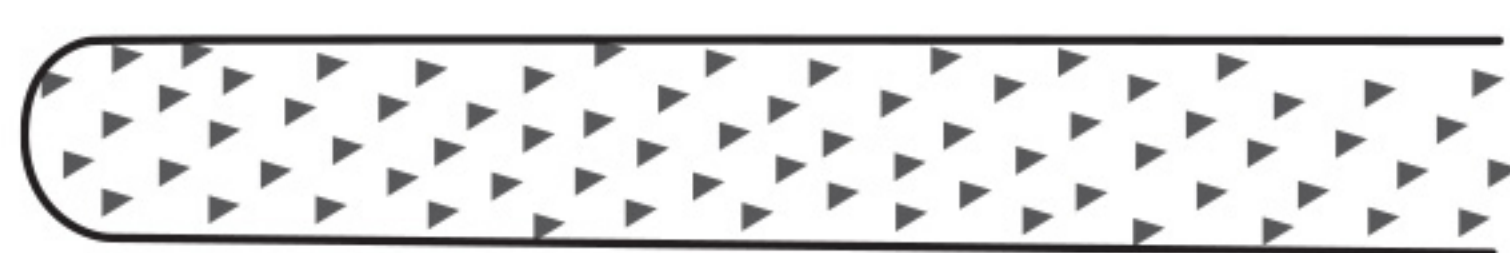

Code	Description
FST-5-211	Chequered
FST-5-212	Knotched

Gallagher Raspatory

190mm long

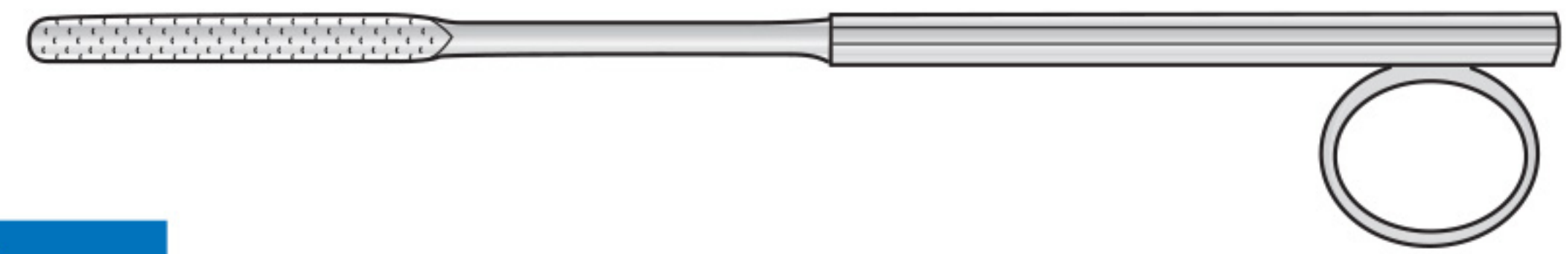
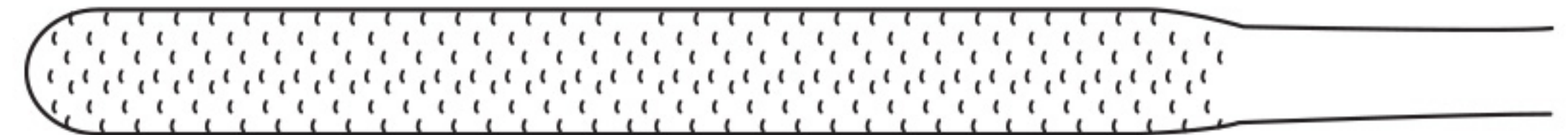

Code
FST-5-203

Joseph Raspatory

Chequered, 165mm long

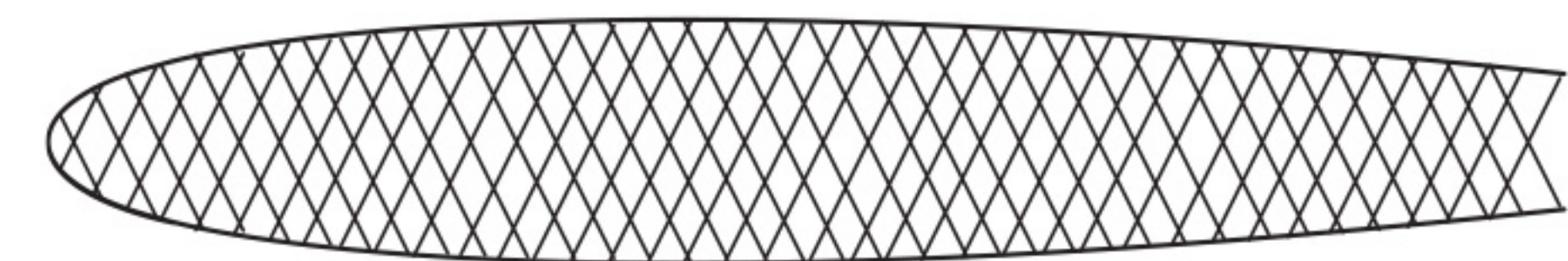
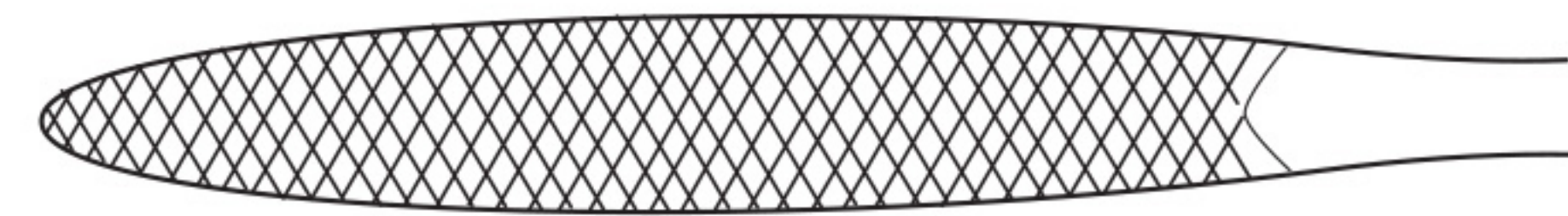

Code	Description
FST-5-209	Fine, 7.5mm
FST-5-210	Coarse, 9mm

Lewis Raspatory

8mm wide, 175mm long

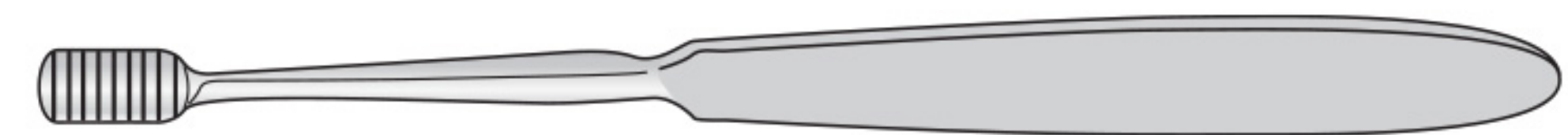

Code	Description
FST-5-213	Fine teeth
FST-5-214	Coarse teeth

Raspatories

Maltz Raspatory

180mm long

Code	Description
FST-5-220	Straight, 9mm
FST-5-221	Straight, 5mm
FST-5-222	Curved, 5mm

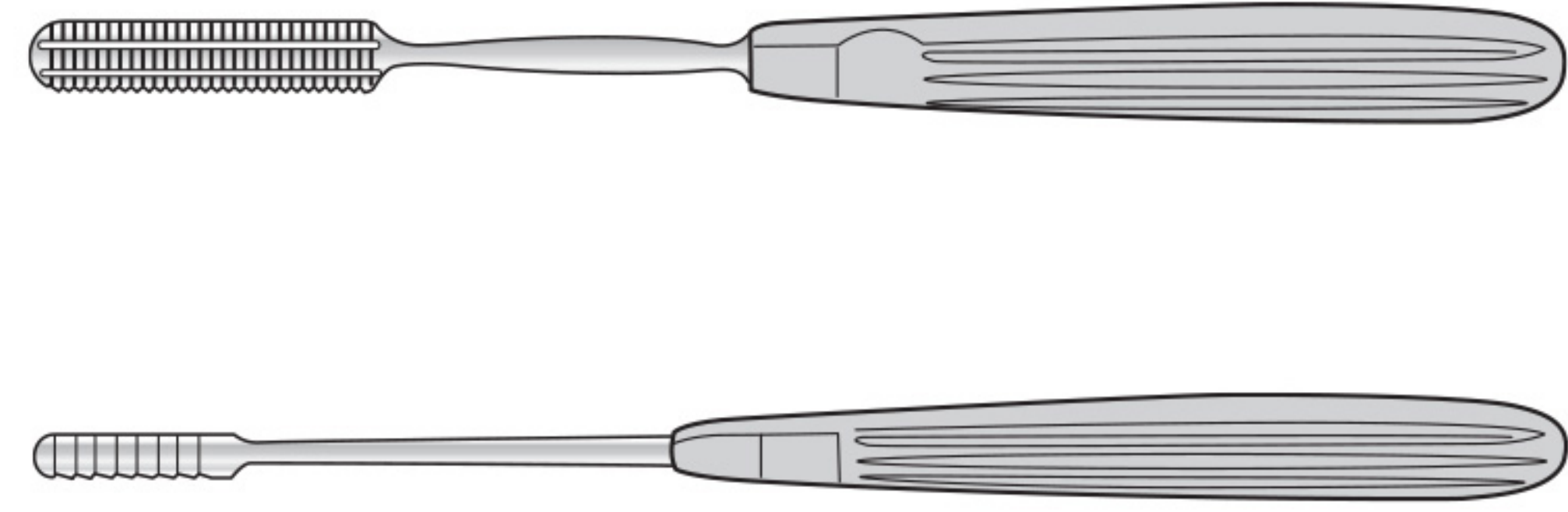
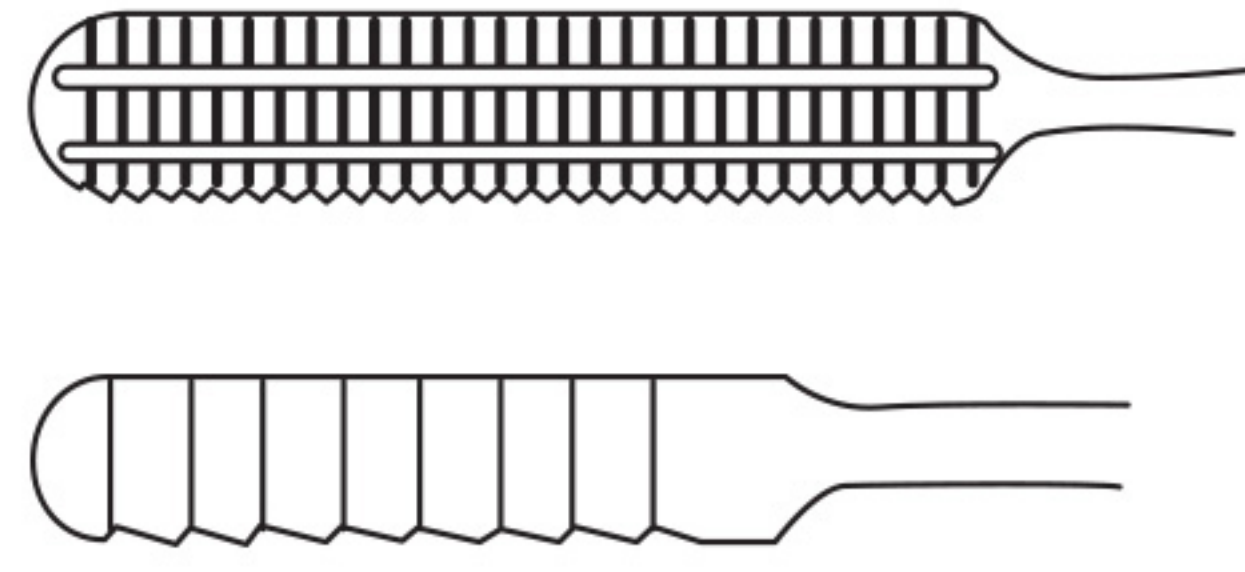

Miller Raspatory

180mm long



Code	Description
FST-5-223	4.3 & 6mm
FST-5-224	5 & 6mm
FST-5-225	5 & 8mm

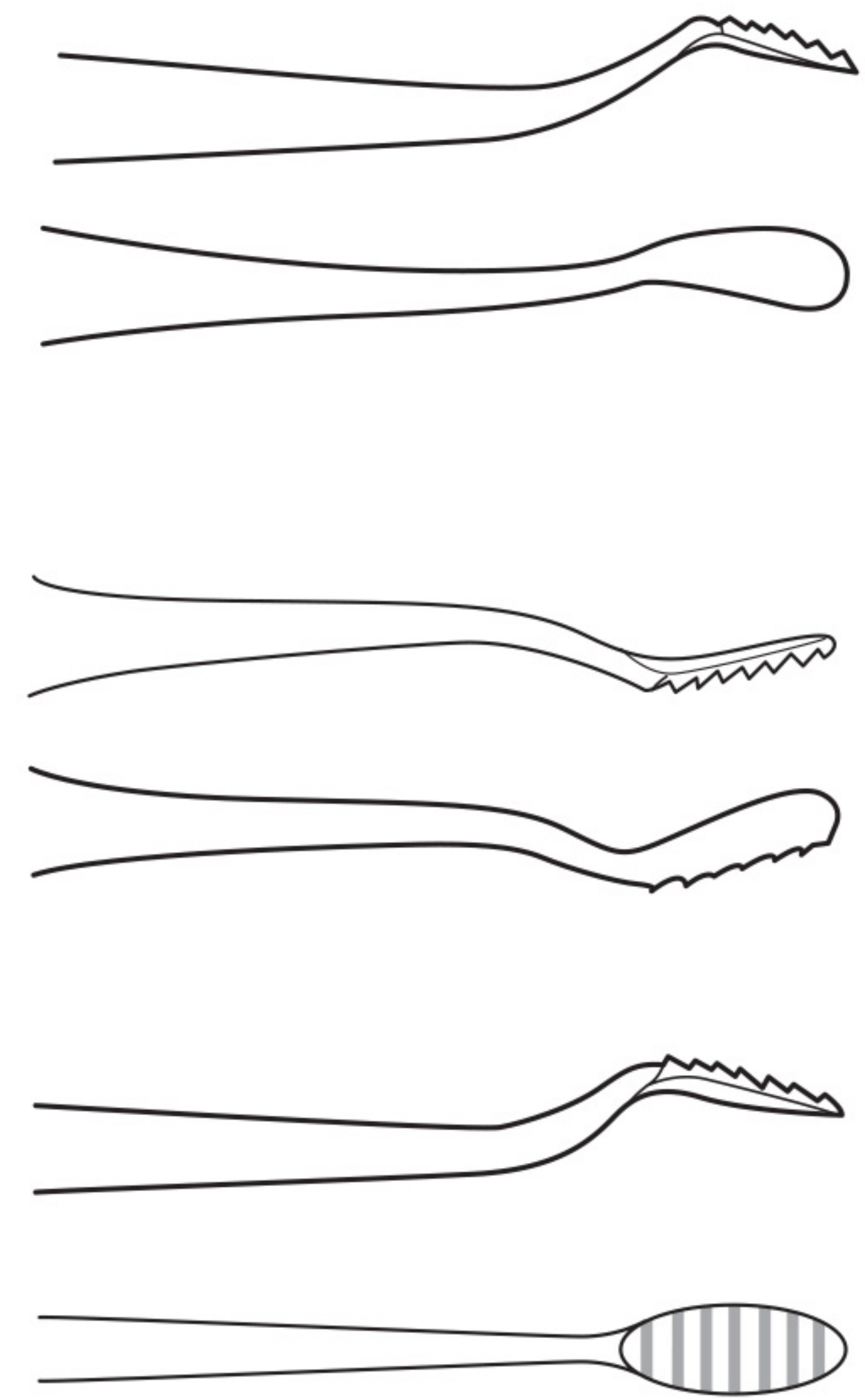
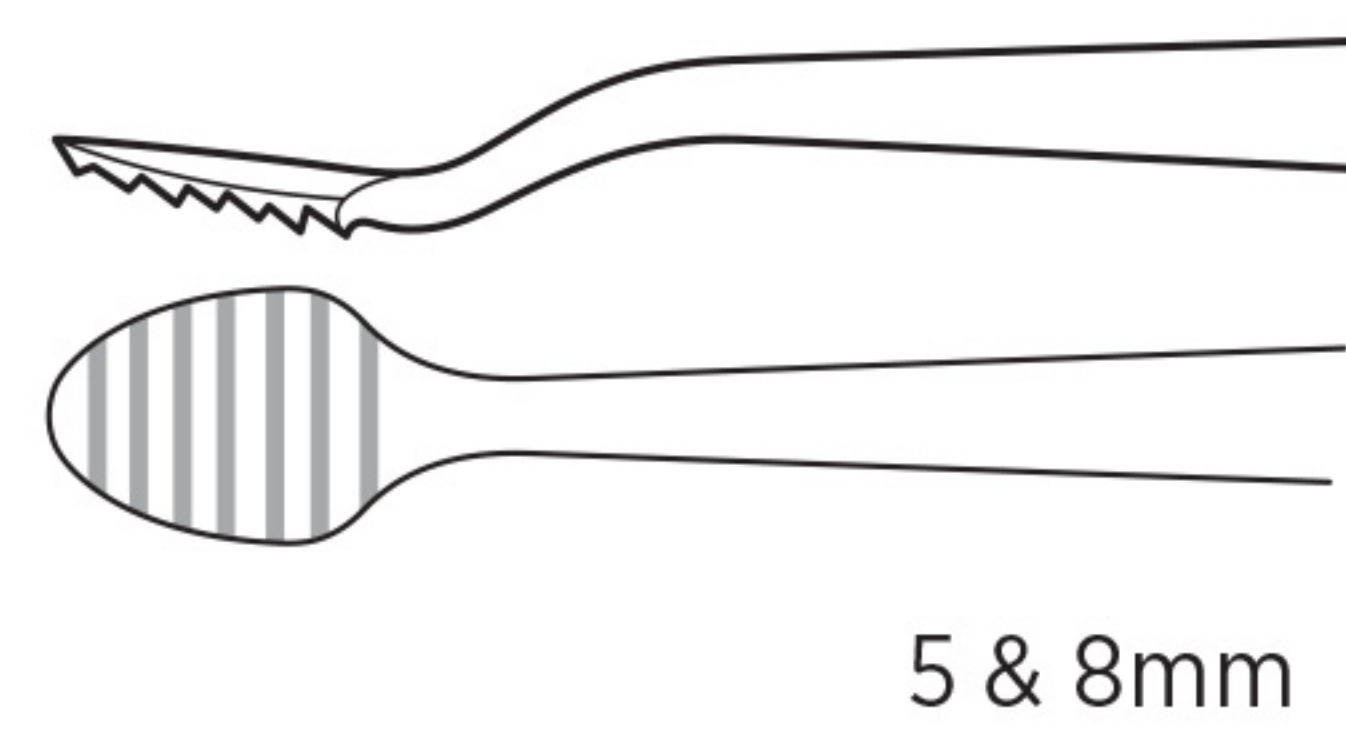
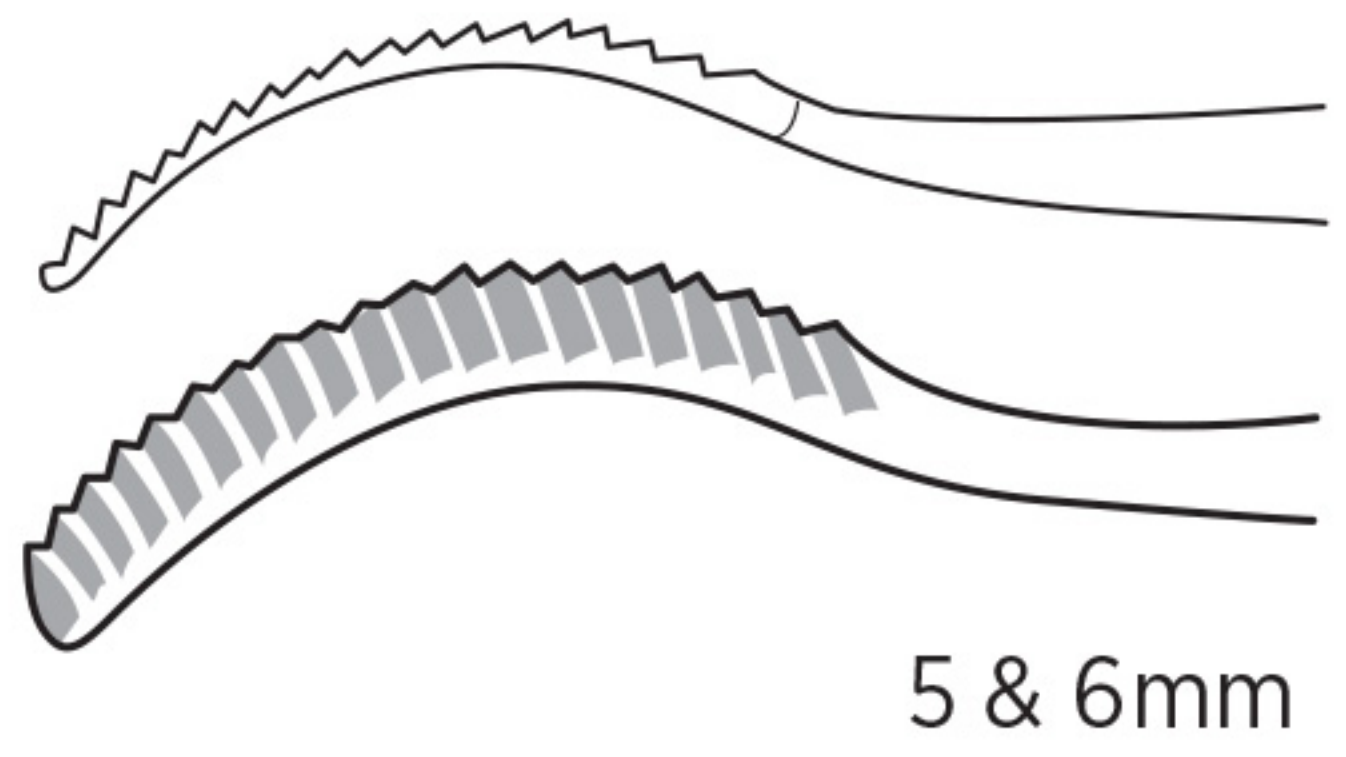
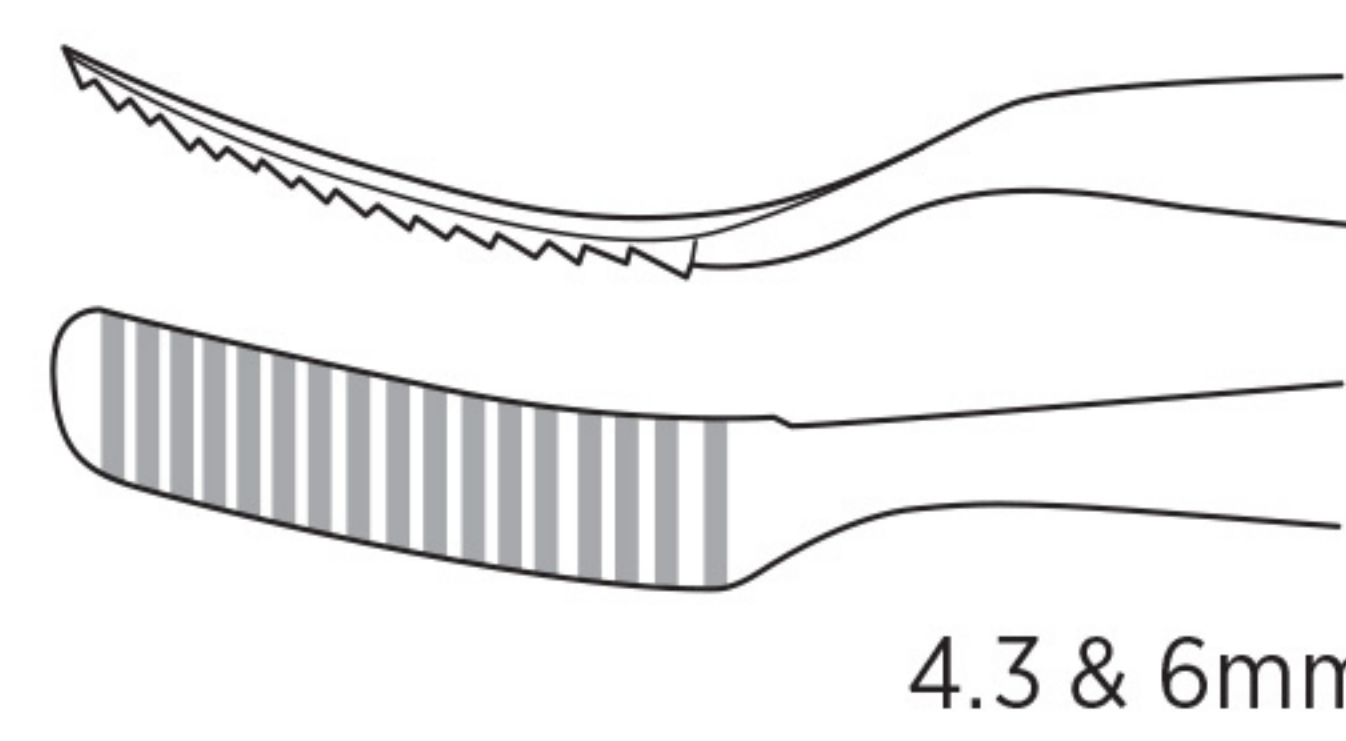

Gillies Dissecting Forceps

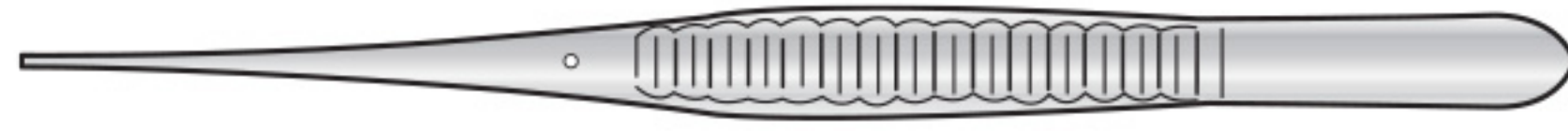

Code	Description
FST-5-230	1 x 2 teeth, 152mm long

McIndoe Dissecting Forceps

152mm long



Code	Description
FST-5-232	1-2 teeth
FST-5-233	Serrated

Waugh Dissecting Forceps

Fine, serrated



Code	Description
FST-5-235	152mm long
FST-5-236	178mm long
FST-5-237	203mm long

College Pattern Stopping and Dressing Forceps

152mm long



Code	Description
FST-5-239	Serrated

Mustarde Dissecting and Suture Holding Forceps

Combined double hooked jaws



Code	Description
FST-5-243	156mm long



Childe Approximating Forceps

With magazine for Michel clips

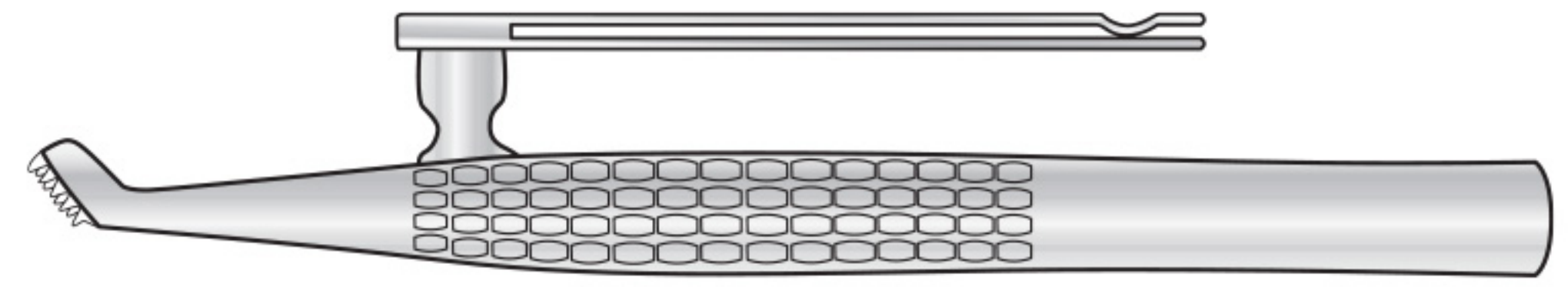

Code	Description
FST-5-231	180mm long

Mitchell Trimmer

165mm long



Code
FST-5-234

Dental Pick



Code	Description
FST-5-238	160mm long

Gillies Skin Hook

190mm long



Code	Description
FST-5-240	Standard
FST-5-241	Half Size

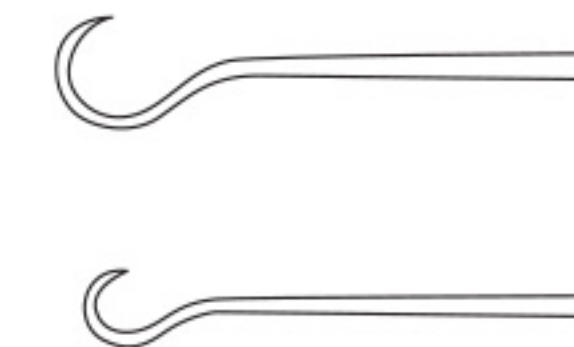

Joseph Double Skin Hook

165mm long



Code
FST-5-242

Kleinert Kutz Skin Hooks



Code	Description
FST-5-244	16cm large
FST-5-245	16cm medium
FST-5-246	16cm small

Retractors

Alms Skin Retractor

Self retaining

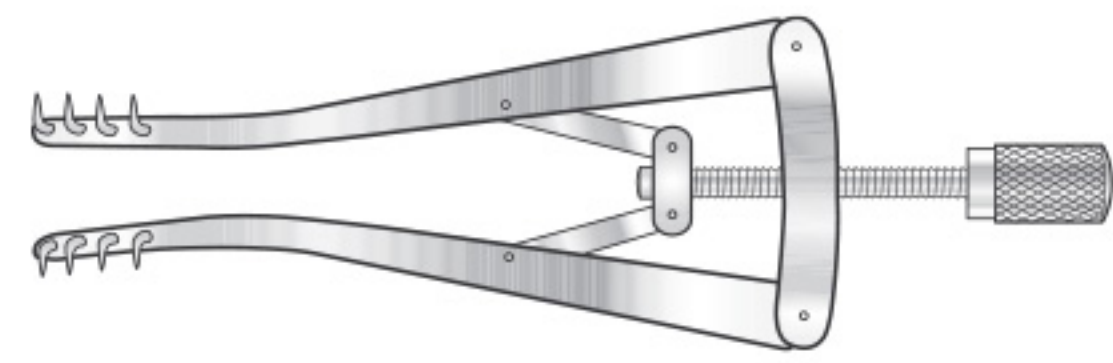

Code	Description
FST-5-260	70mm long
FST-5-261	100mm long

Austin Kay Retractor

85mm long

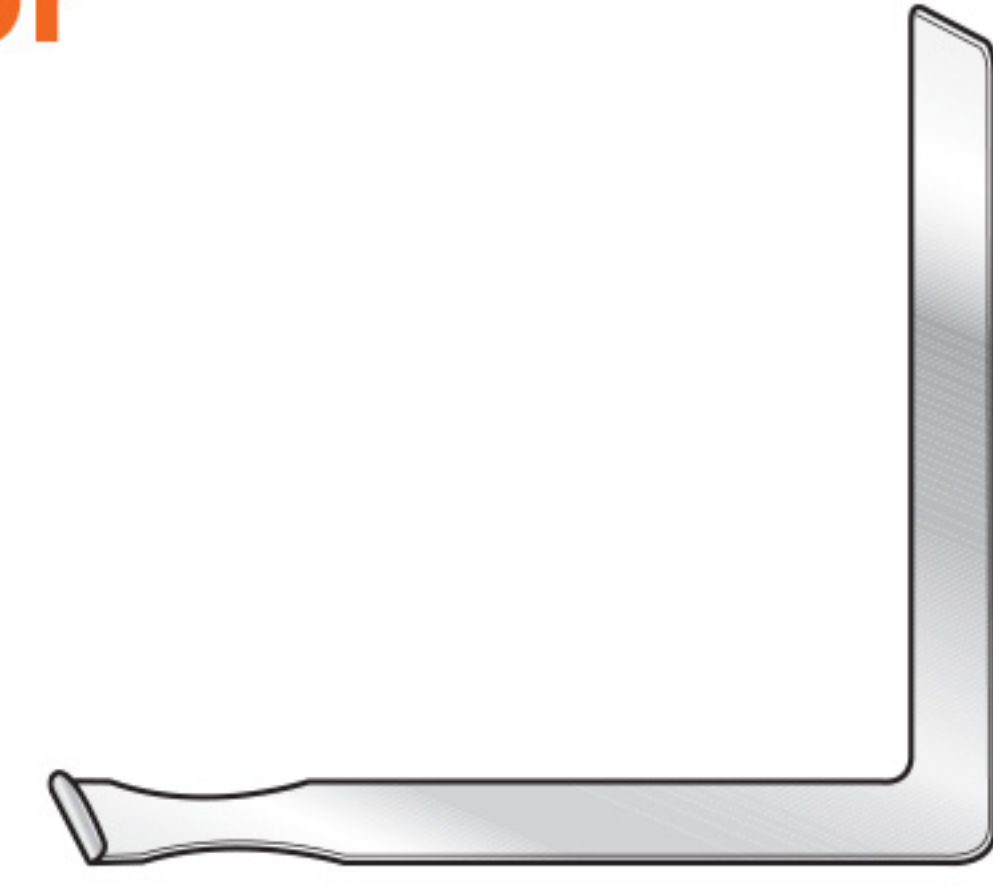

Code	Description
FST-5-262	16mm wide

Kilner Retractor

Double ended, cat's paw

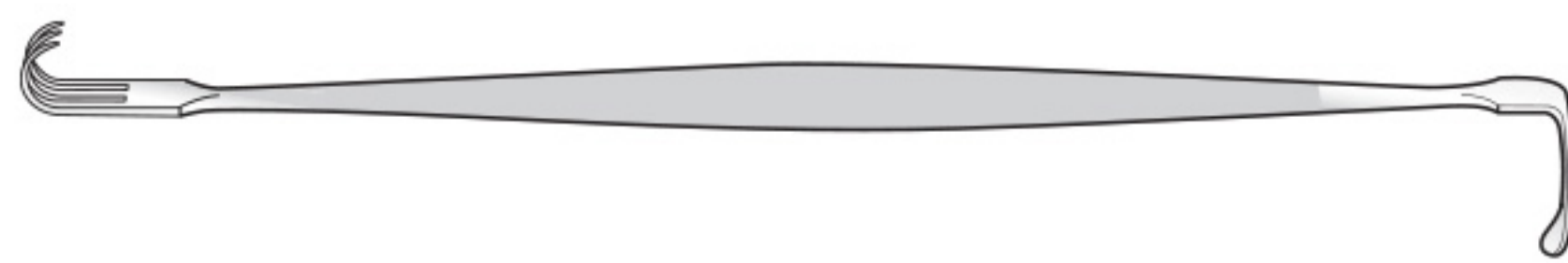

Code	Description
FST-5-263	152mm long

Bowdler Henry Retractor

170mm long

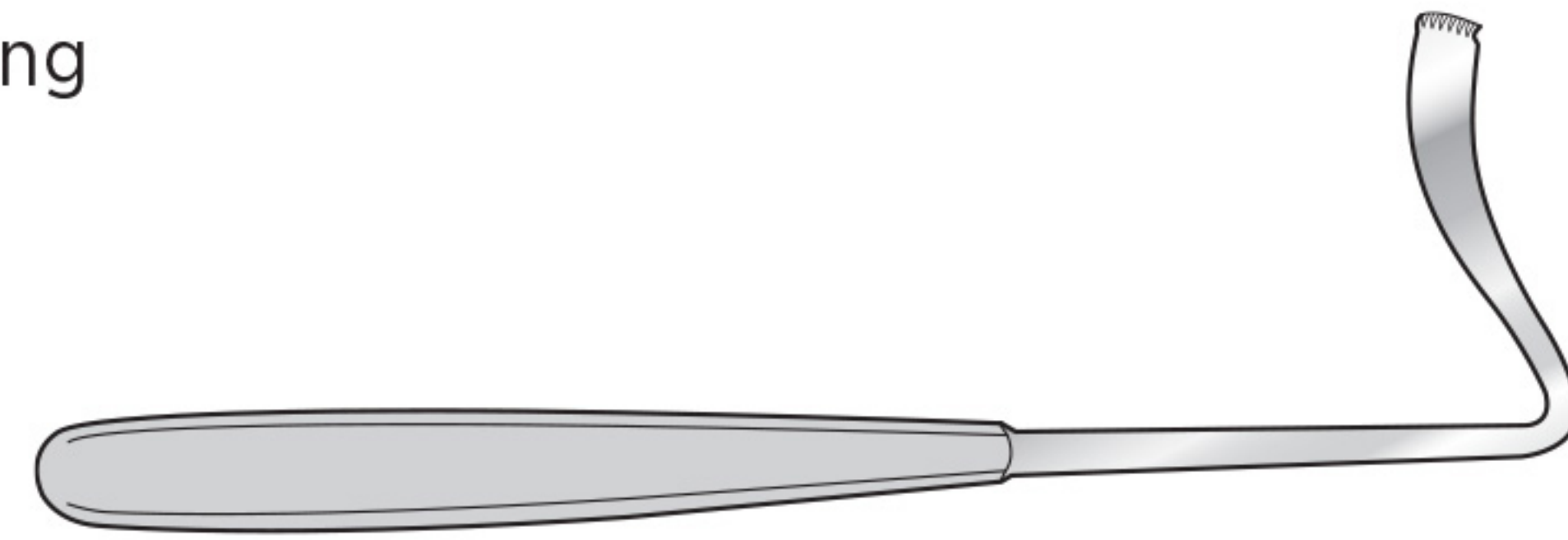

Code	Description
FST-5-264	12mm wide

Kilner Alae Retractor

85mm long



Code	Description
FST-5-265	10mm
FST-5-266	13mm

Tongue Retractor

190mm long

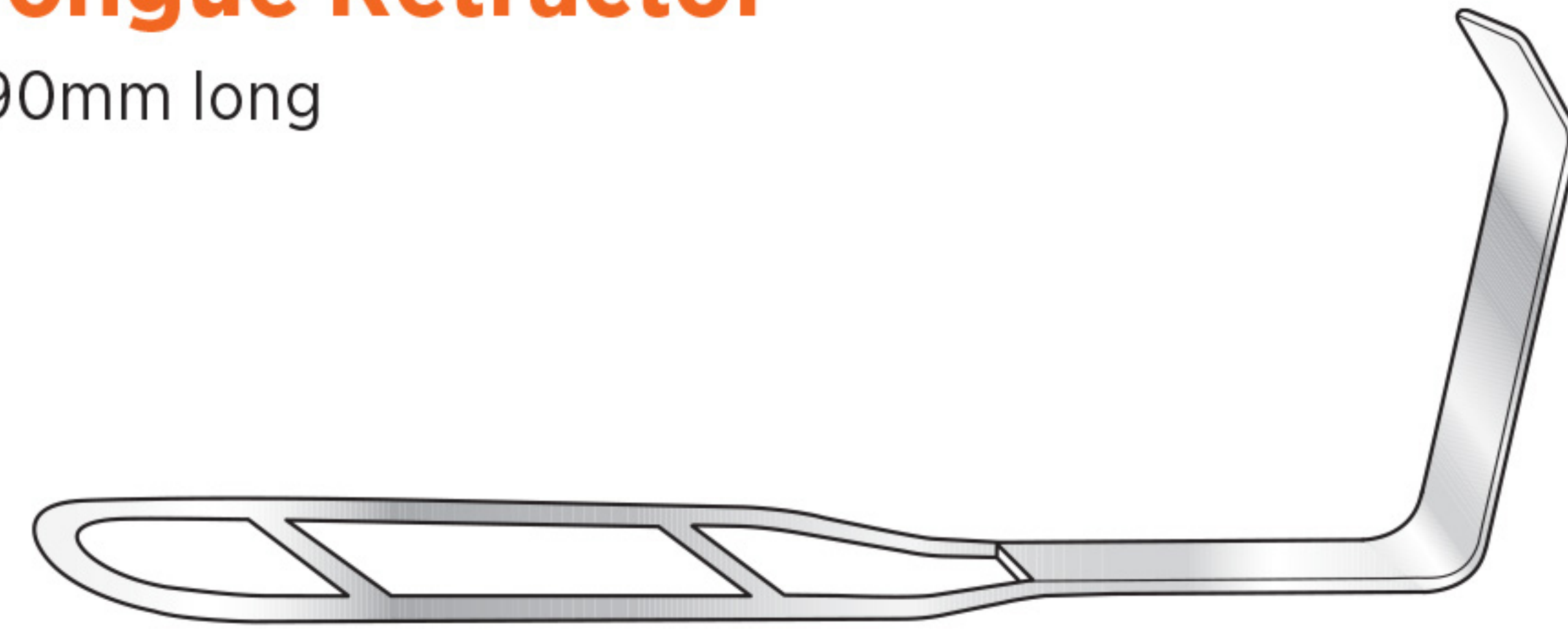

Code	Description
FST-5-267	12mm wide

Cheek Retractor

140mm long

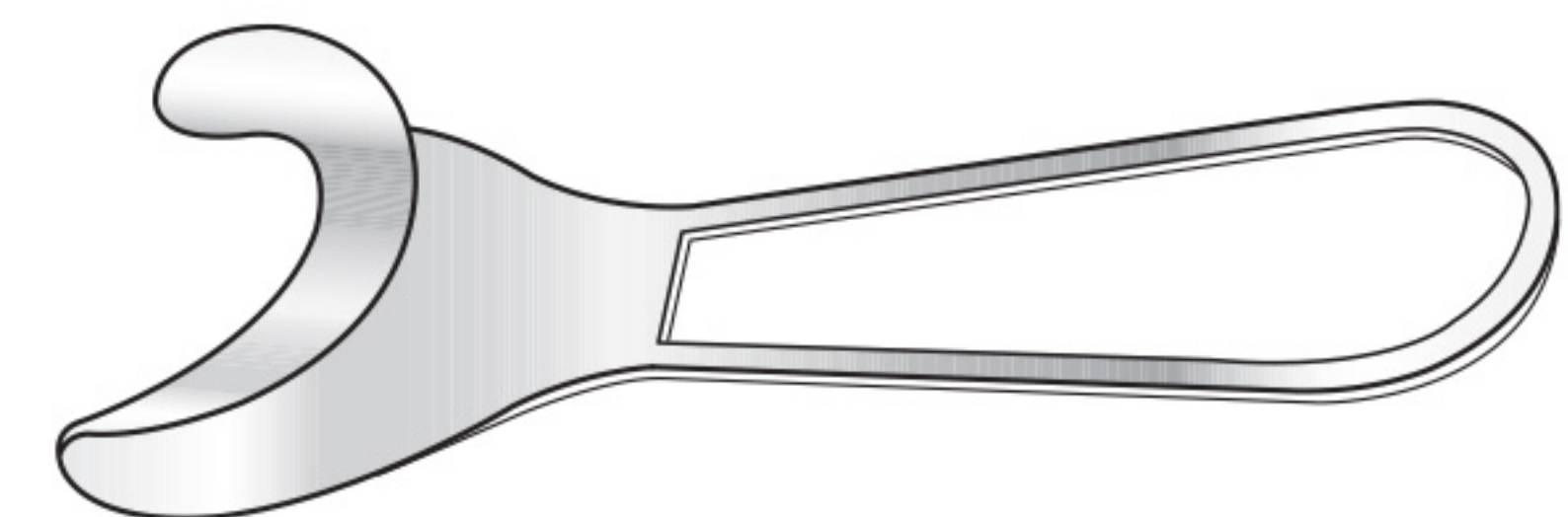

Code	Description
FST-5-268	40mm wide

Ragnell Davis Retractor

140mm long

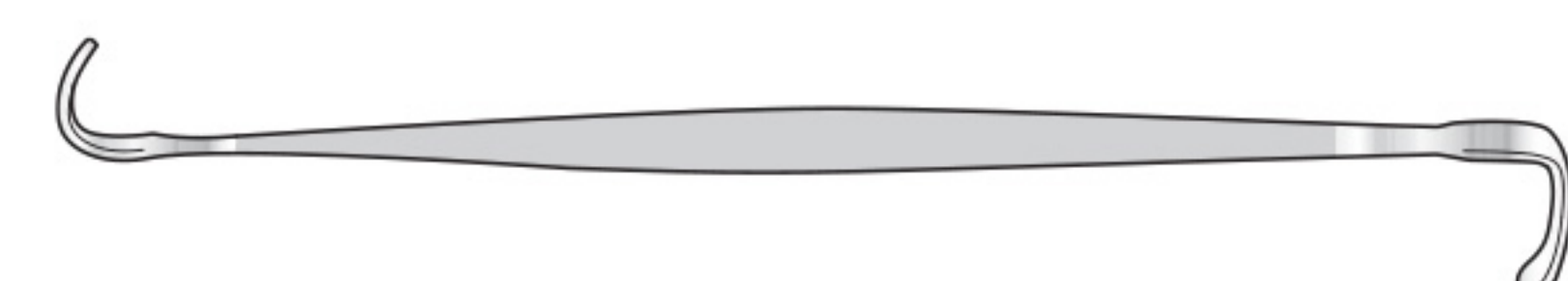

Code
FST-5-269

Flap Retractor

180mm long

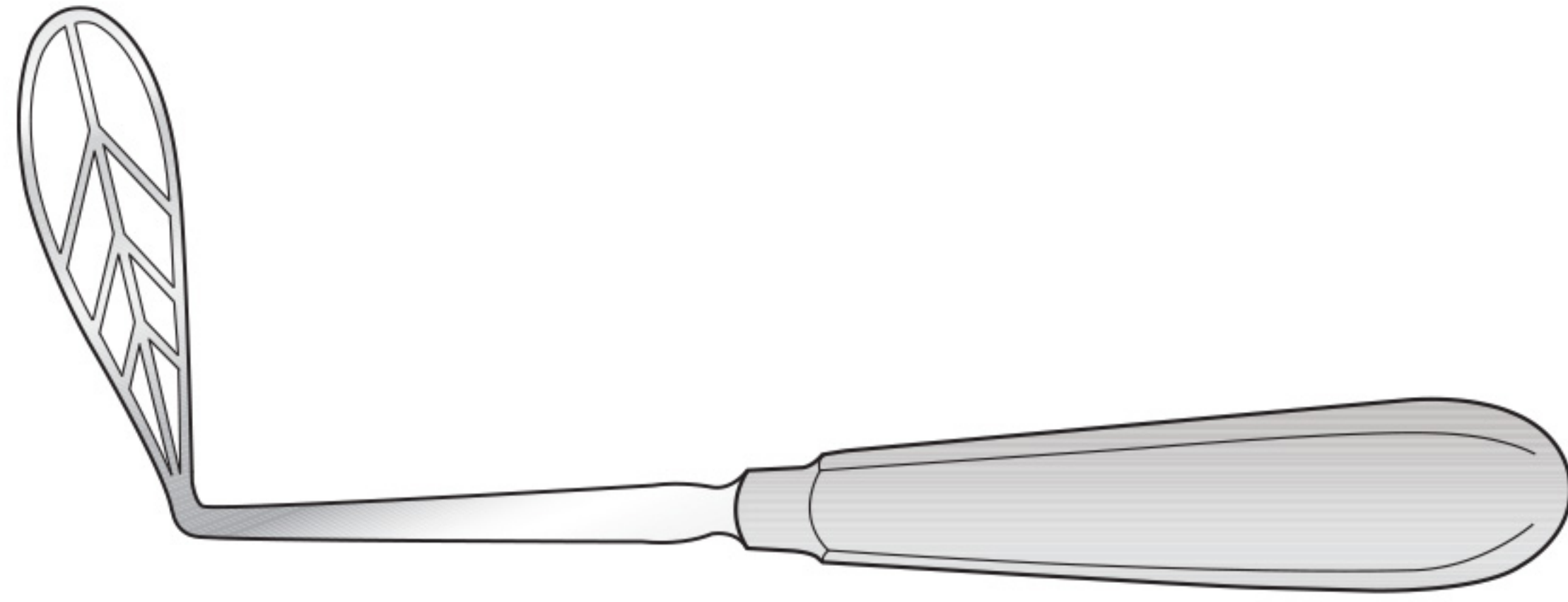

Code	Description
FST-5-280	32mm wide

Kilner Cheek Retractor

Double ended, 167mm long



Code	Description
FST-5-281	Small, 19mm and 25mm wide
FST-5-282	Large, 29mm and 35mm wide

Kilner Nasal Retractor

152mm long

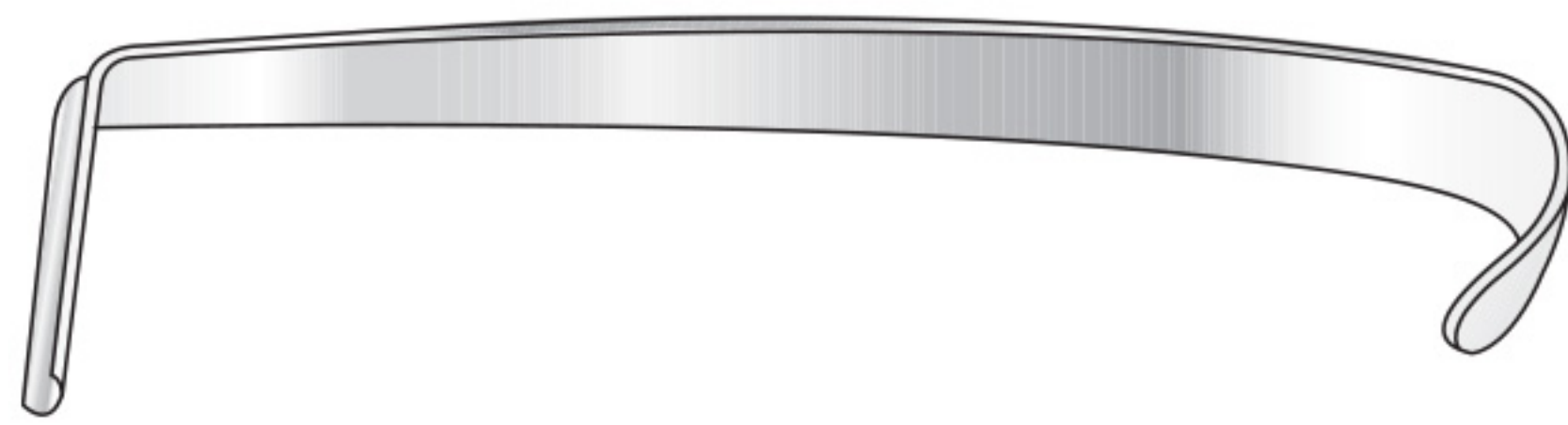

Code	Description
FST-5-283	7mm wide

Laster Cheek Retractor

110mm long

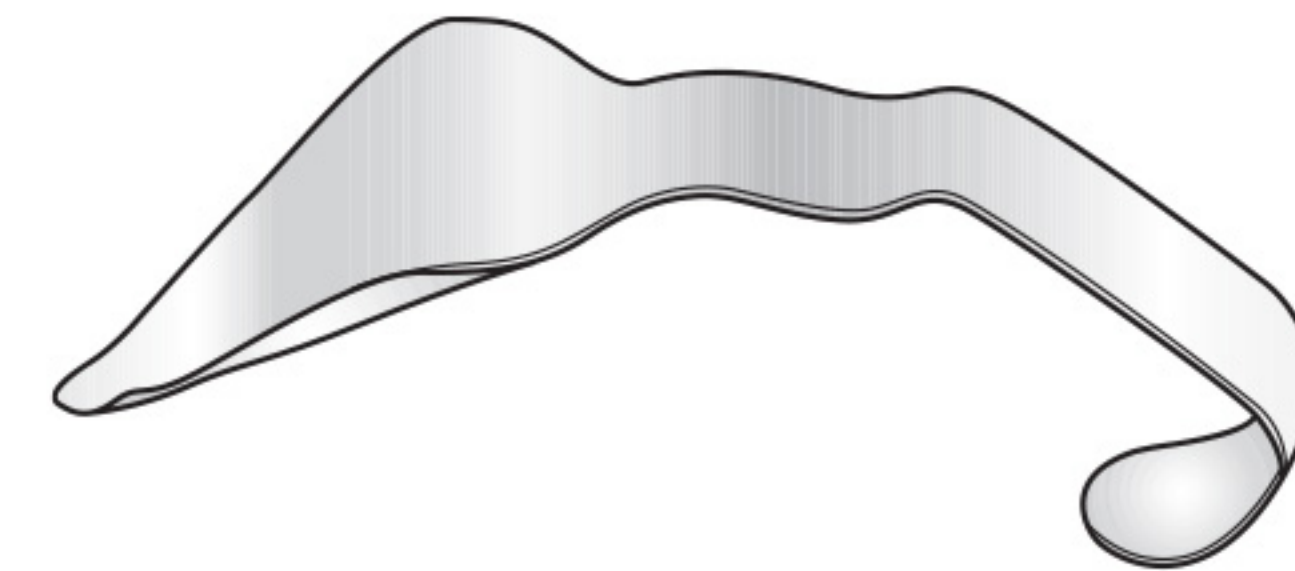

Code	Description
FST-5-284	35mm wide

Hajek Retractor

Upper lip, 165mm long

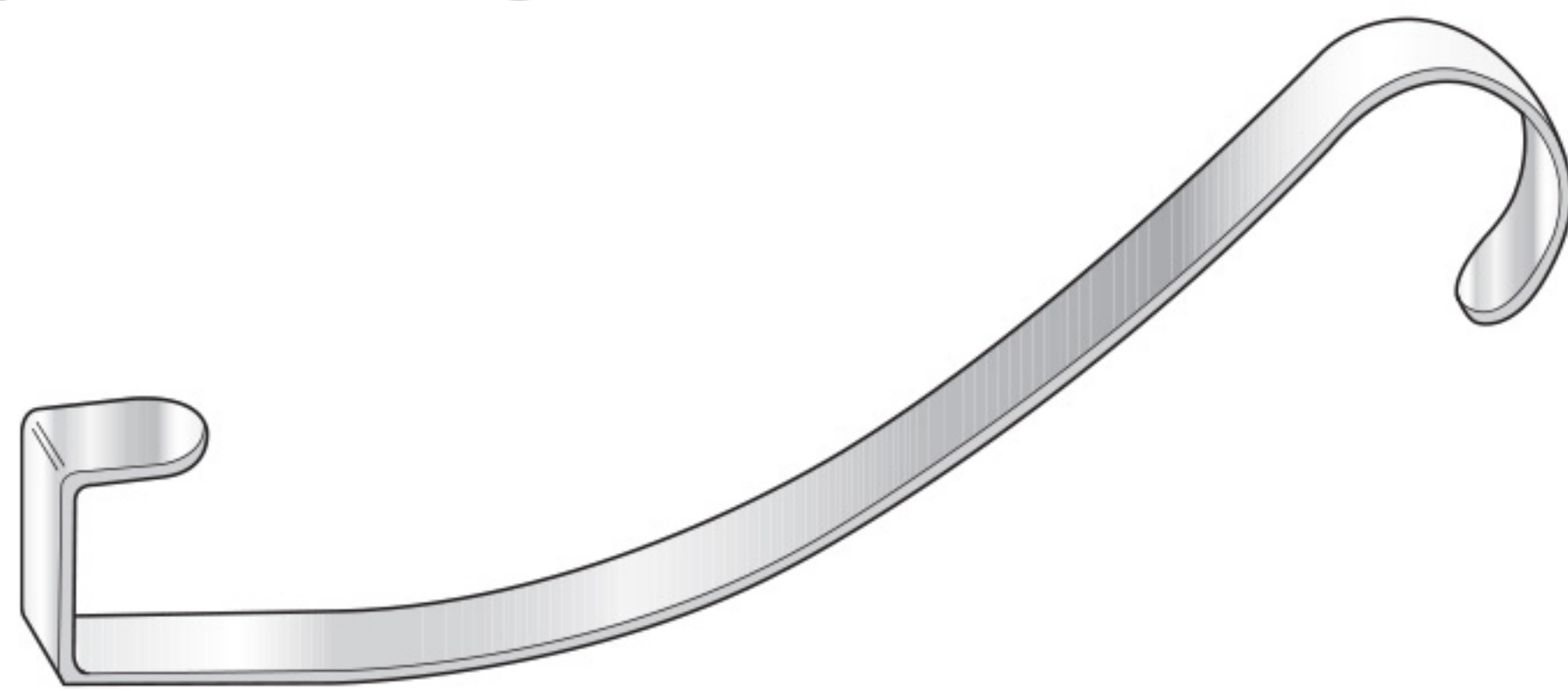

Code	Description
FST-5-285	20mm wide

Freece Oral Retractor

150mm long

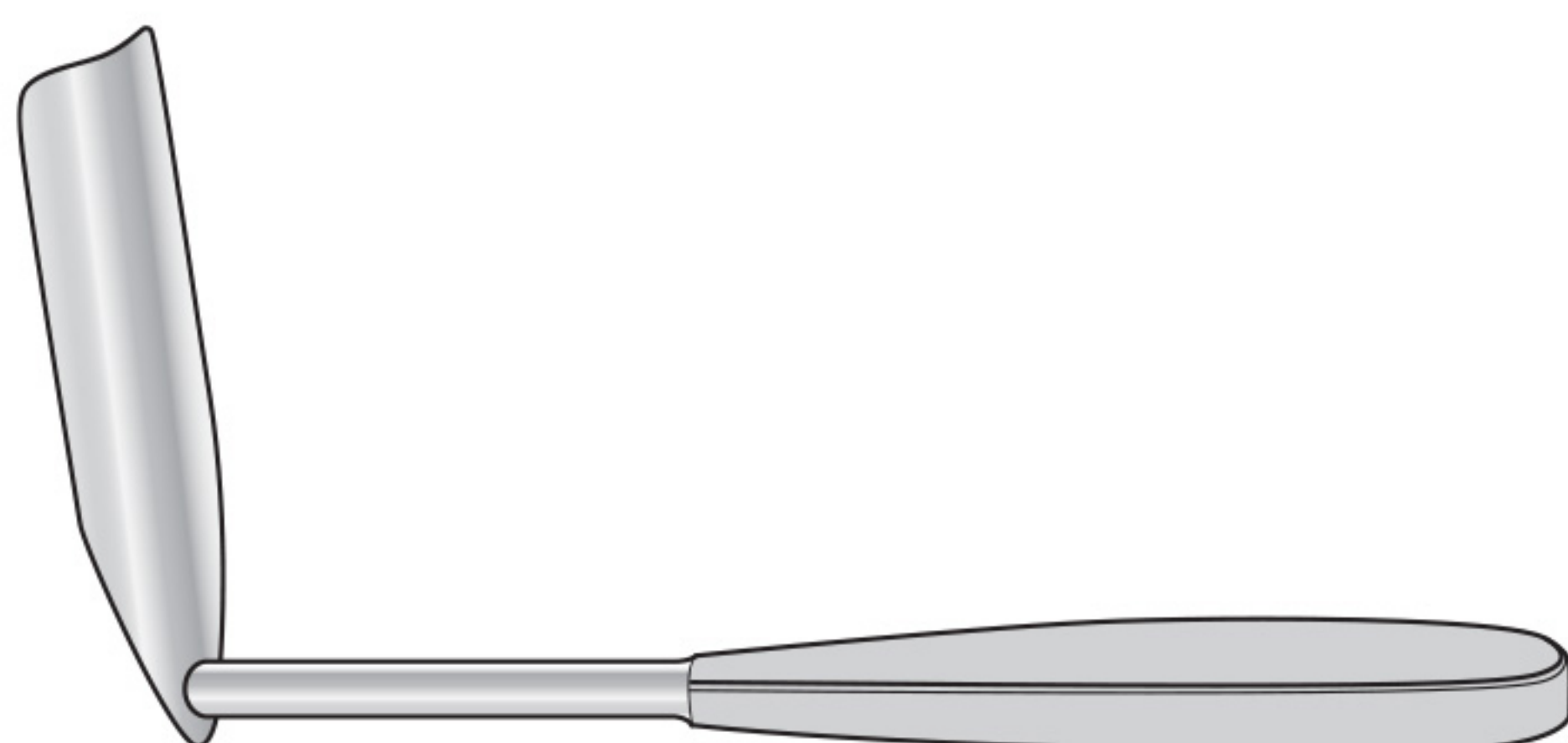

Code	Description
FST-5-286	33mm wide

Osteotomes, Chisels and Gouges

Ward (East Grinstead) Osteotome

Square handle, 178mm long

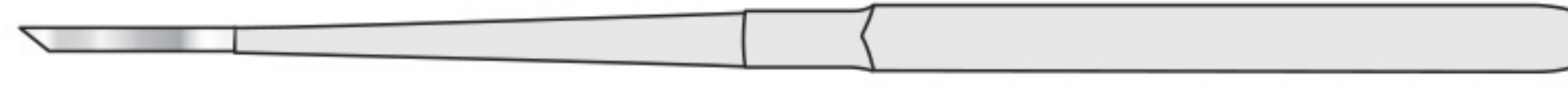

Code	Description
FST-5-295	3mm wide
FST-5-296	5mm wide

Silver Nasal Chisel

182mm long

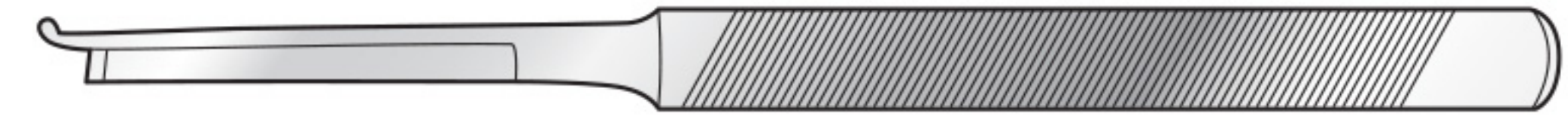

Code	Description
FST-5-297	Straight
FST-5-298	Curved to right
FST-5-299	Curved to left

Gillies (French Pattern) Osteotome

140mm long

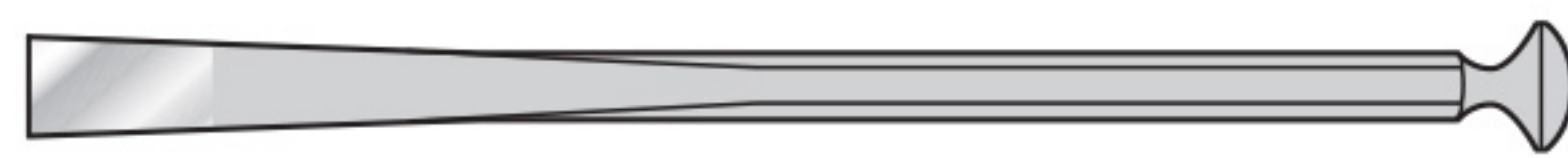

Code	Description
FST-5-300	3mm wide
FST-5-301	5mm wide
FST-5-302	7mm wide
FST-5-303	9mm wide
FST-5-304	11mm wide
FST-5-305	16mm wide

Pterigoideus (Maxilla) Chisel

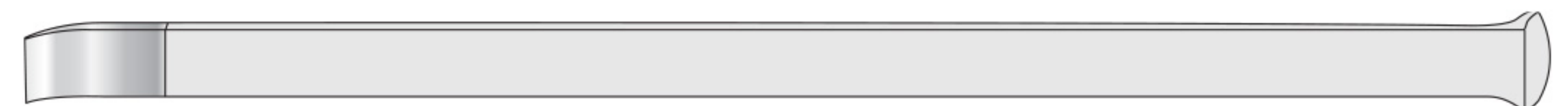

Code	Description
FST-5-306	255mm long

Jenkins Chisel

140mm long

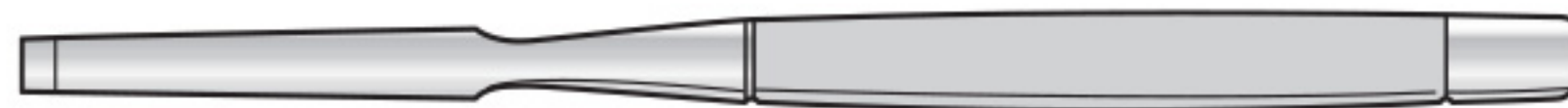

Code	Description
FST-5-307	2mm wide
FST-5-308	4mm wide
FST-5-309	6mm wide
FST-5-310	8mm wide
FST-5-311	10mm wide

Tilley Septum Gouge

V shaped, straight

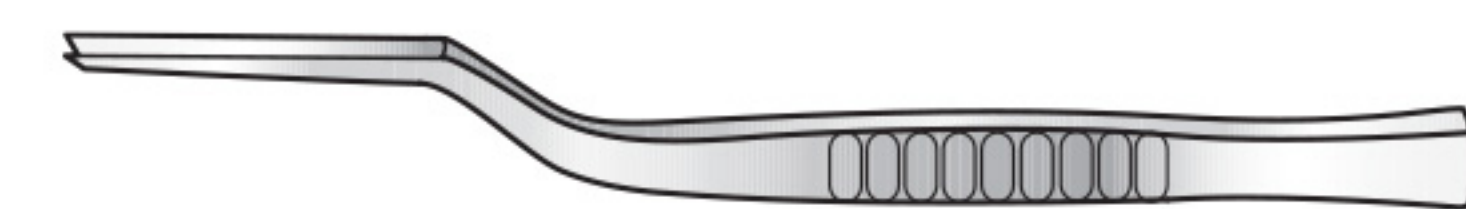

Code	Description
FST-5-312	127mm long

McIndoe Nasal Chisel

152mm long

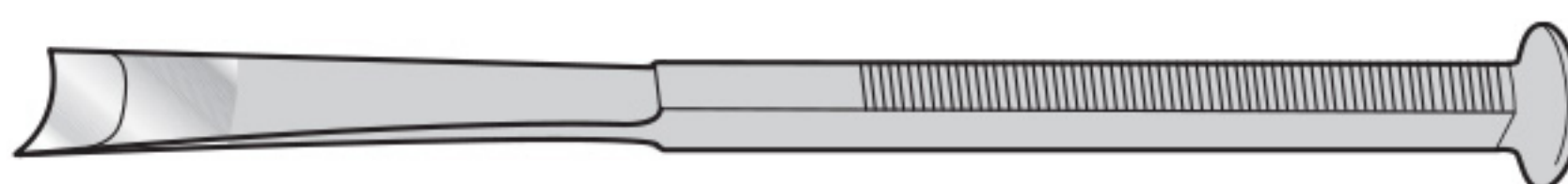

Code	Description
FST-5-313	5mm wide
FST-5-314	7mm wide
FST-5-315	9mm wide
FST-5-316	11mm wide

Fickling Dental Mallet

191mm long

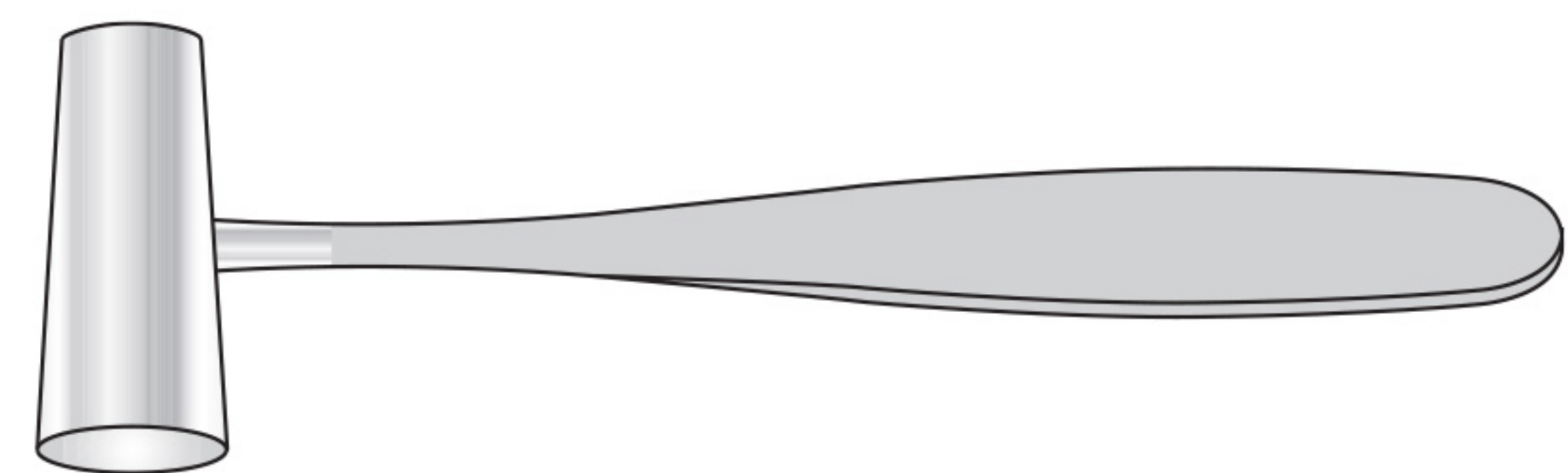

Code	Description
FST-5-317	25mm ø, tapering head

Silver Skin Graft Knife

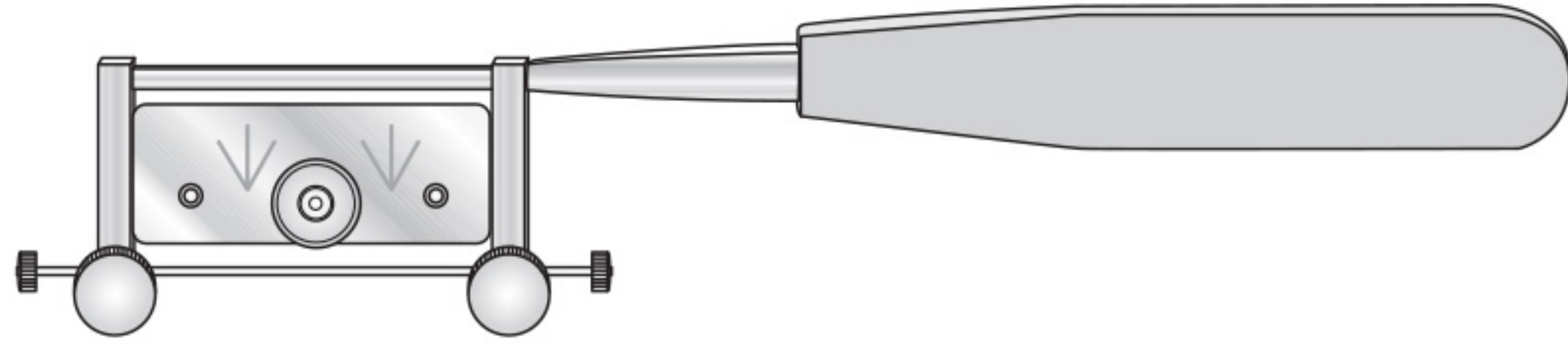

Code	Description
FST-5-325	190mm long

Eckhoff Mapping Pen



Code	Description
FST-5-328	145mm long
FST-5-329	Nibs packs of 10

Sommerland Surgical Marking Pen

Adjustable four-pointed tip



Code	Description
FST-5-330	152mm long

Gillies Suction Tube

Control valve, 180mm long

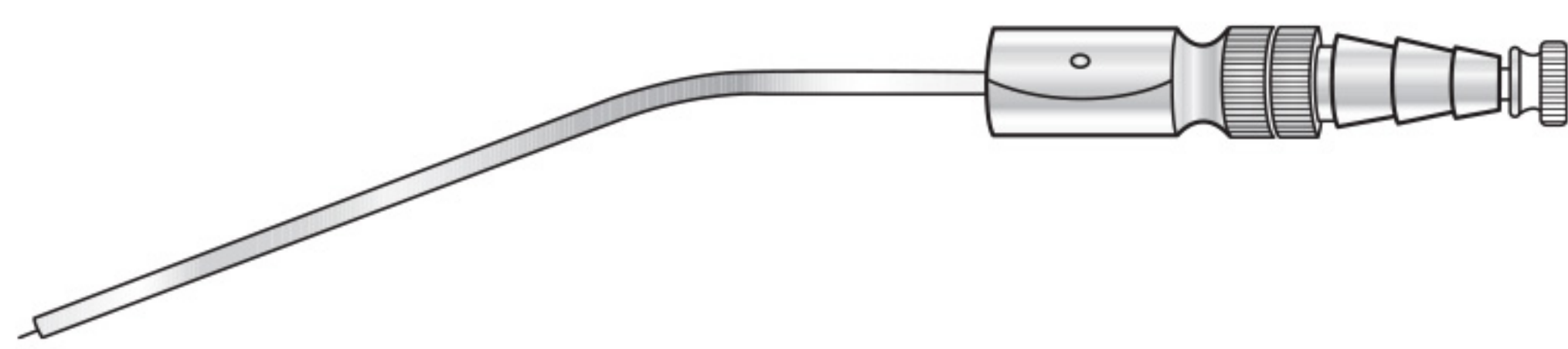

Code	Description
FST-5-333	2.5mm
FST-5-334	3mm
FST-5-335	3.5mm

Watson Skin Graft Knife

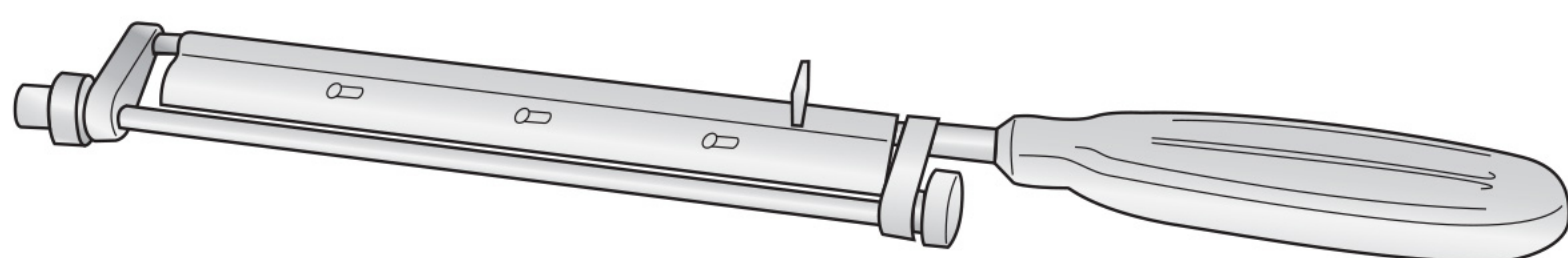

Code	Description
FST-5-337	Right-handed
FST-5-338	Left-handed

Doyen Mouth Gag

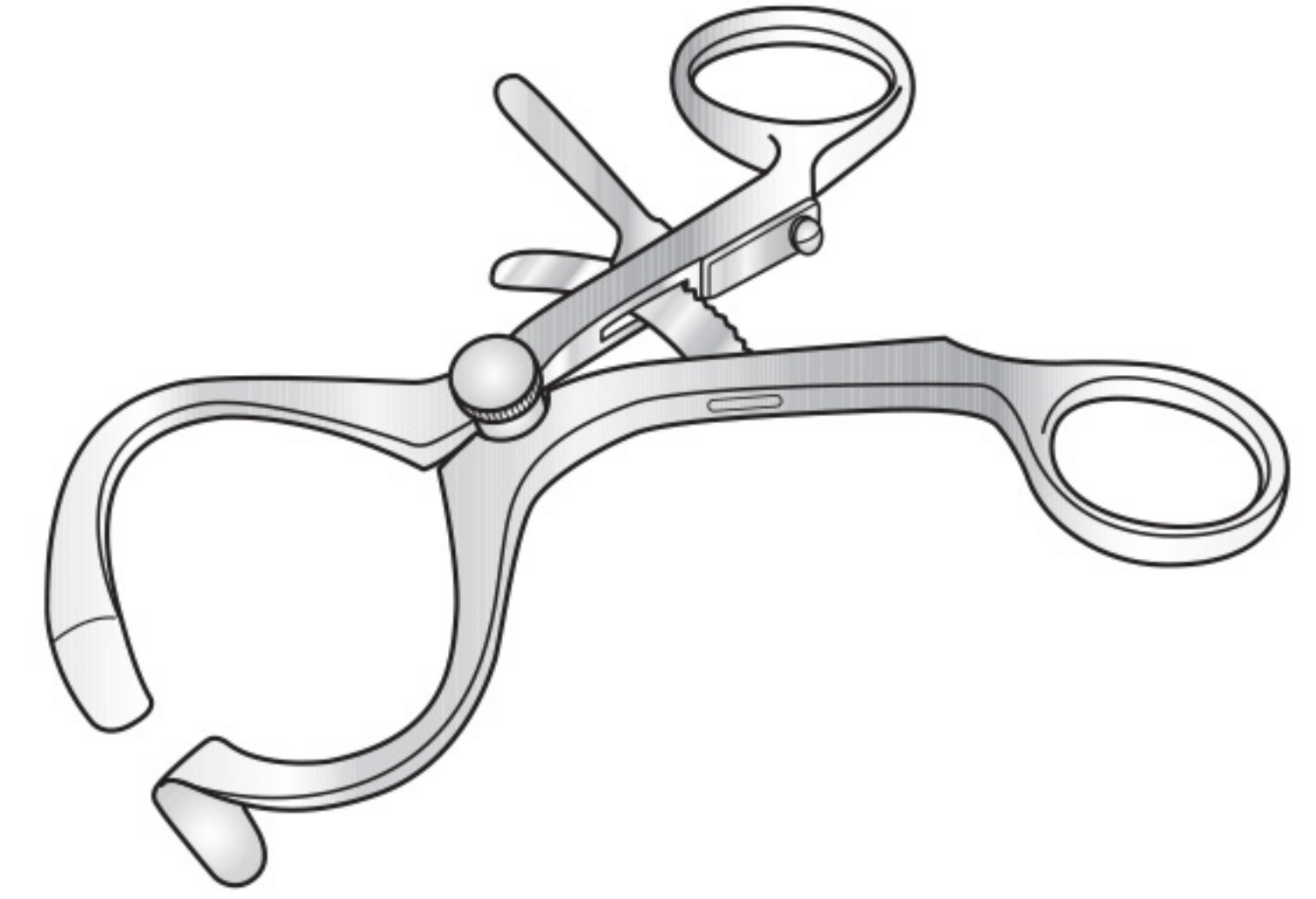

Code	Description
FST-5-326	Adult
FST-5-327	Child

Fergusson Ackland Mouth Gag

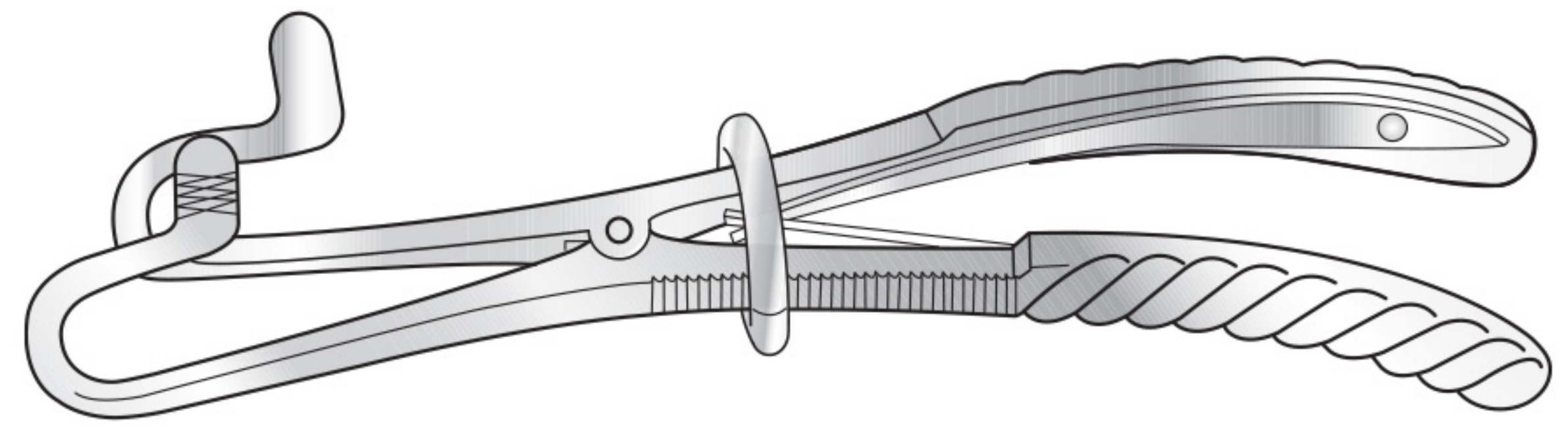

Code	Description
FST-5-331	Adult, 210mm
FST-5-332	Child, 155mm

Dental Cartridge Syringe

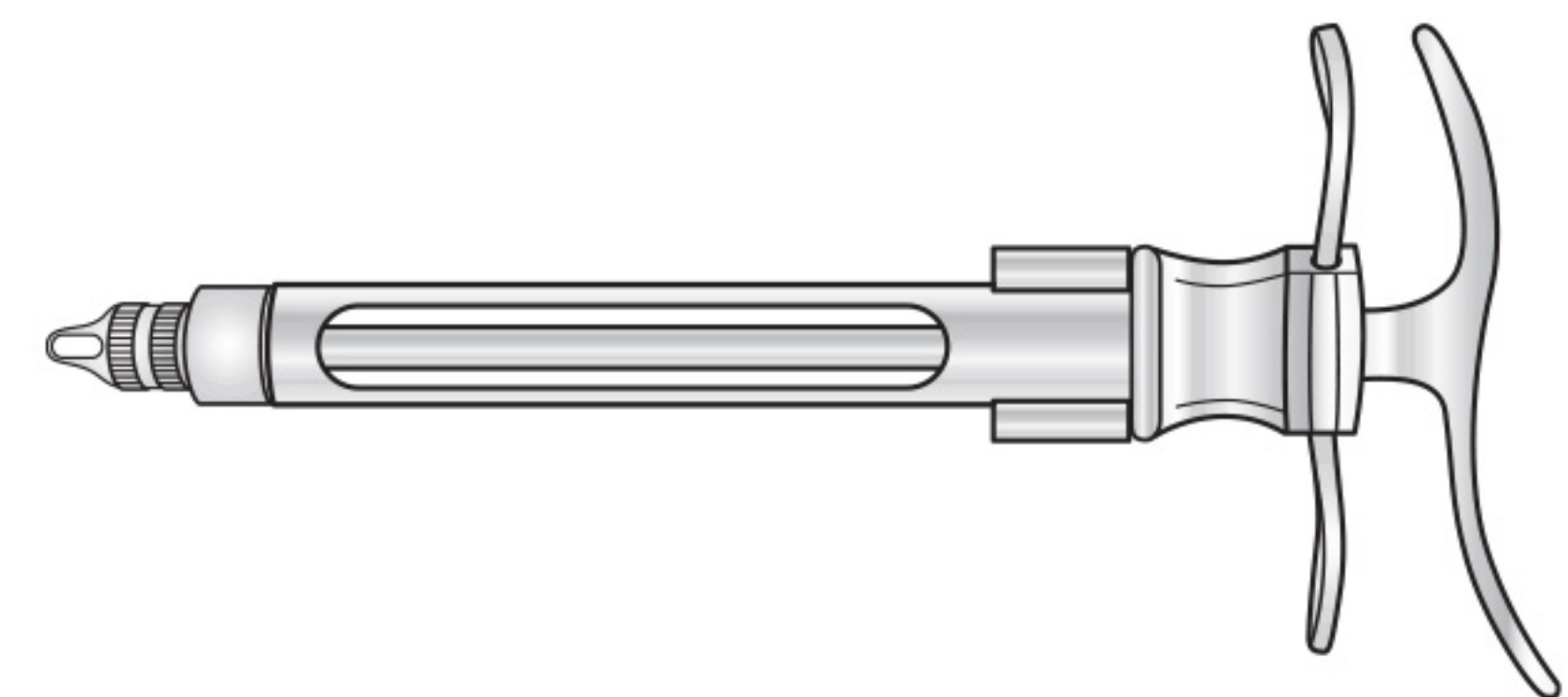

Code	Description
FST-5-336	115mm long

Miscellaneous

Freeman Areola Nipple Sizer

1.5mm

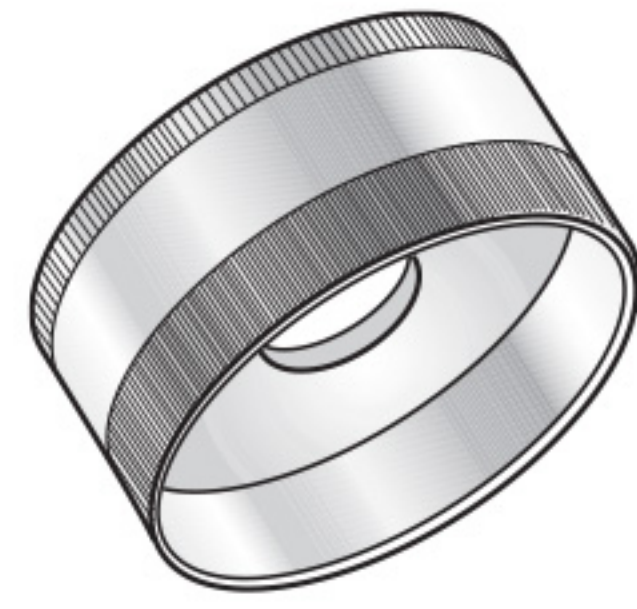

Code	Description
FST-5-345	25mm ø
FST-5-346	40mm ø
FST-5-347	45mm ø
FST-5-348	50mm ø
FST-5-349	55mm ø

Kelsey Fry Bone Awl

148mm long

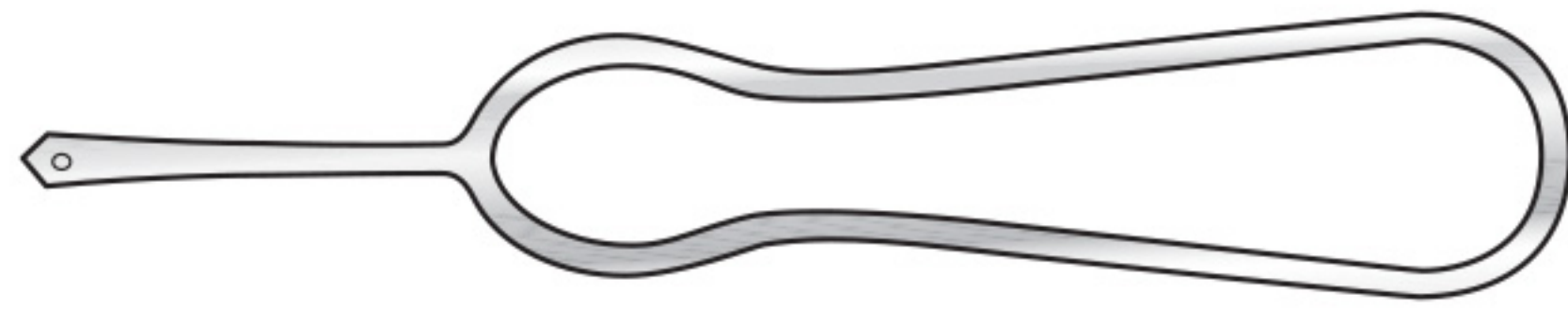

Code	Description
FST-5-351	Straight
FST-5-352	Curved

Joseph Nasal Saw

Blade 35mm long

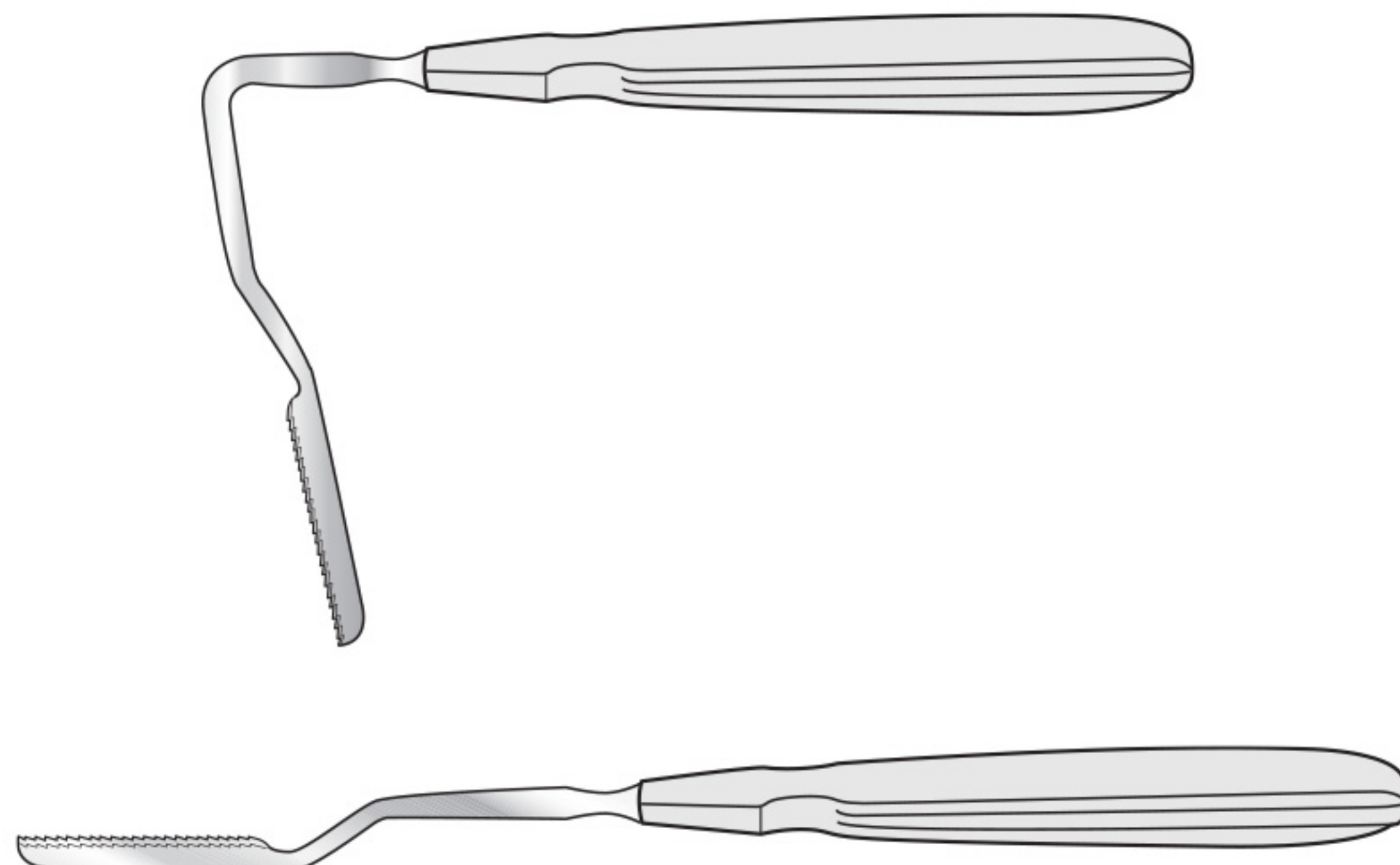

Horizontal shaft

Code	Description
FST-5-355	Cranked right
FST-5-356	Cranked left

Vertical shaft

Code	Description
FST-5-357	Cranked right
FST-5-358	Cranked left

Unna Comedo Expressor Double Ended Curette

2mm / 1mm holes



Code	Description
FST-5-350	135mm long

Lang Steel Scoop

Double ended



Code	Description
FST-5-353	7mm x 4mm, 140mm long

McHardy Curette

136mm long



Code	Description
FST-5-354	1mm, 1.5mm, and 2mm ø

MacEwen Curette

Combined with seeker, 165mm long



Code	Description
FST-5-359	Oval
FST-5-360	Round



CONTACT US



Address: P.O Box 2953, 6 Awan Street Ugoki Road,
Shahab Pura Sialkot - Pakistan



Phone: +92 52 325 7510



Phone: +92 52 324 1879



Email: info@fstinternational.com



website: www.fstinternational.com

