



WWW.FSTINTERNATIONAL.COM

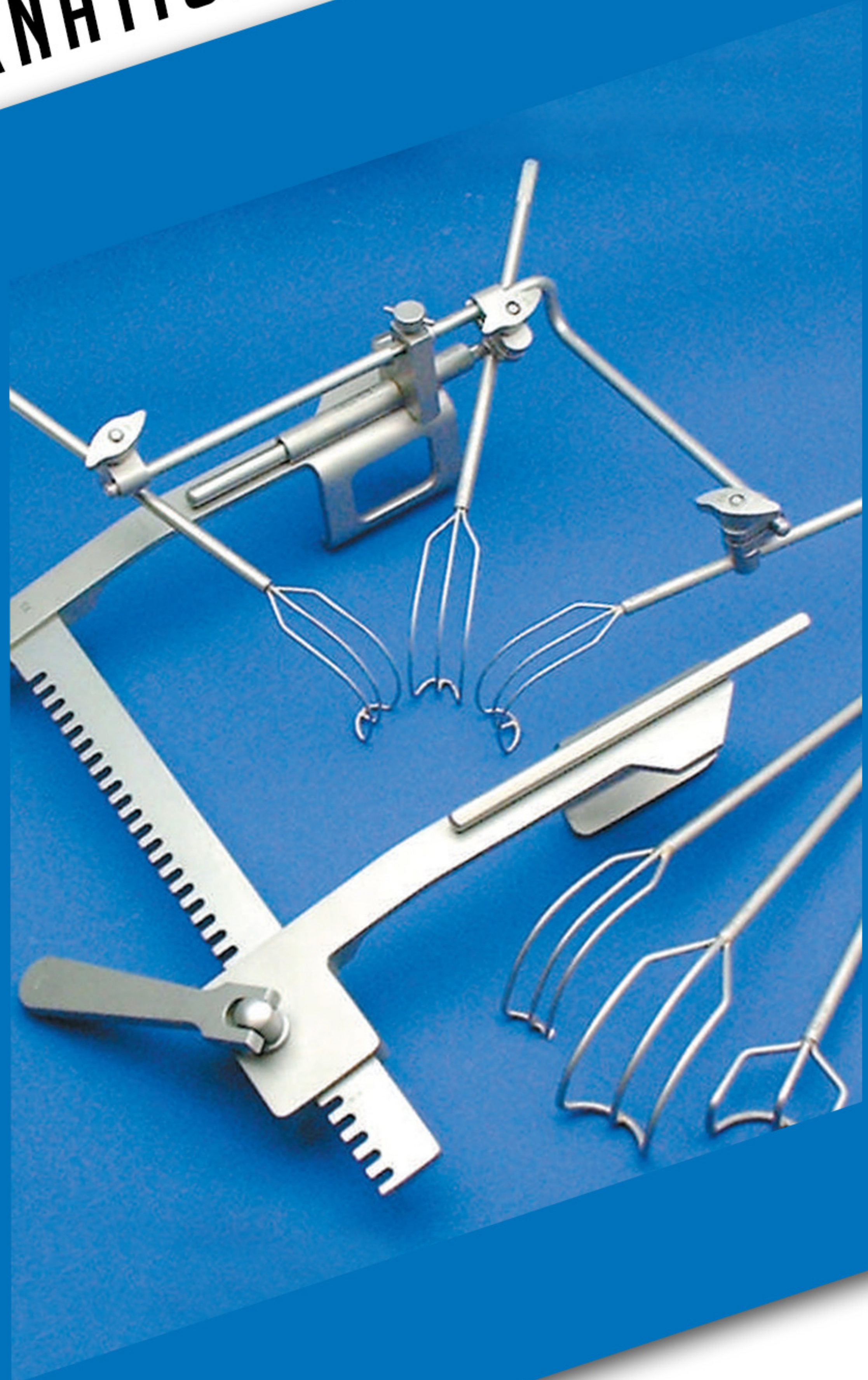
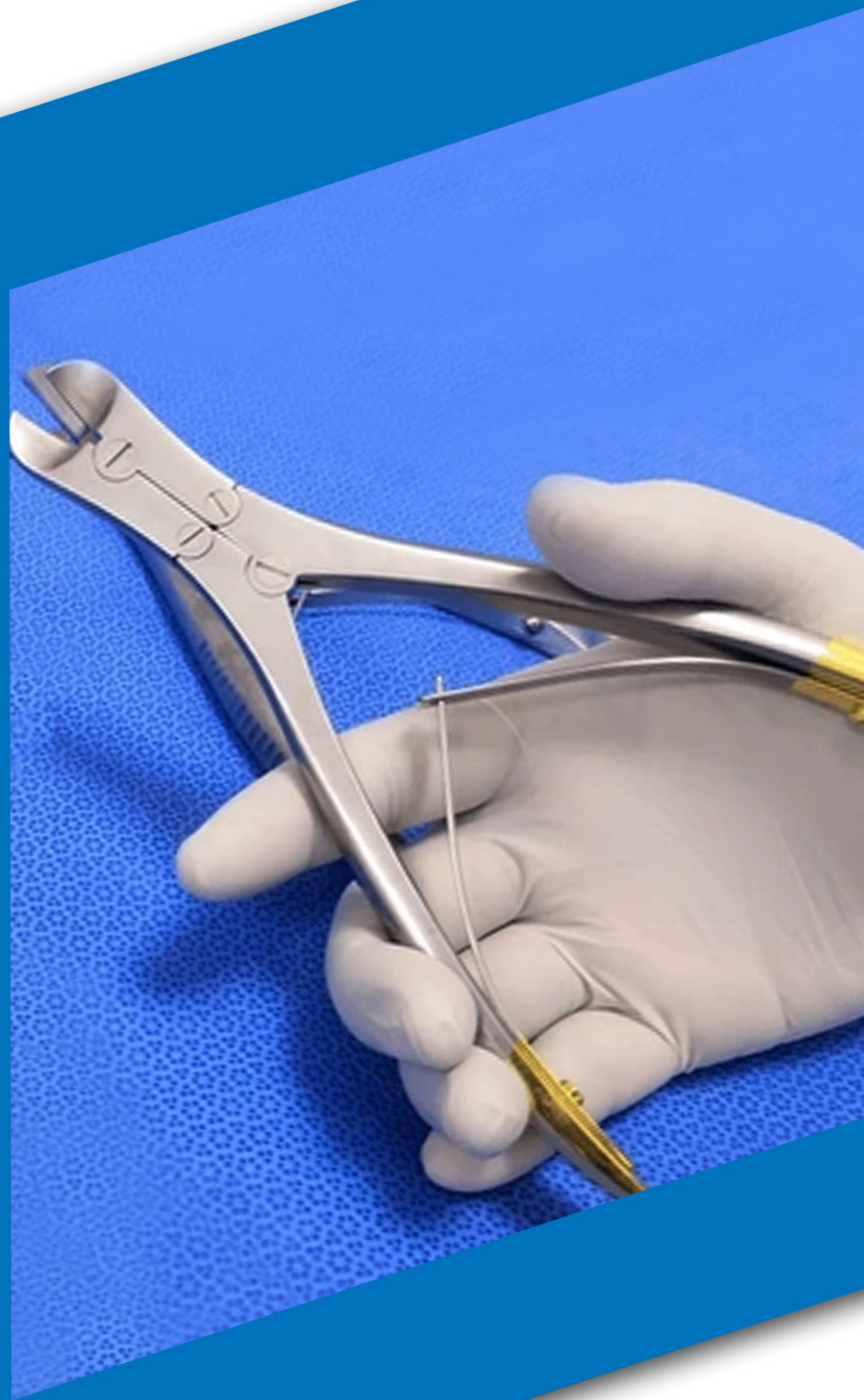

TABLE OF CONTACTS

Orthopaedic

01	Bone Cutting Forceps	03
02	Bone Rongeurs	04-05-06
03	Bone Holding Forceps	07-08
04	Bone Holding Clamps	09
05	Plaster Spreaders and Shears	10
06	Bone Curettes	11-12-13-14-15
07	Bone Levers	16
08	Retractors	17-18
09	Dissecting Forceps and Hooks	19
10	Raspatories, Burr and Rugines	20
11	Osteotomes, Chisels and Gouges	21-22

Bone Cutting Forceps

McIndoe Bone Cutting Forcep

Lightweight, compound action, angled jaw with prismatic points

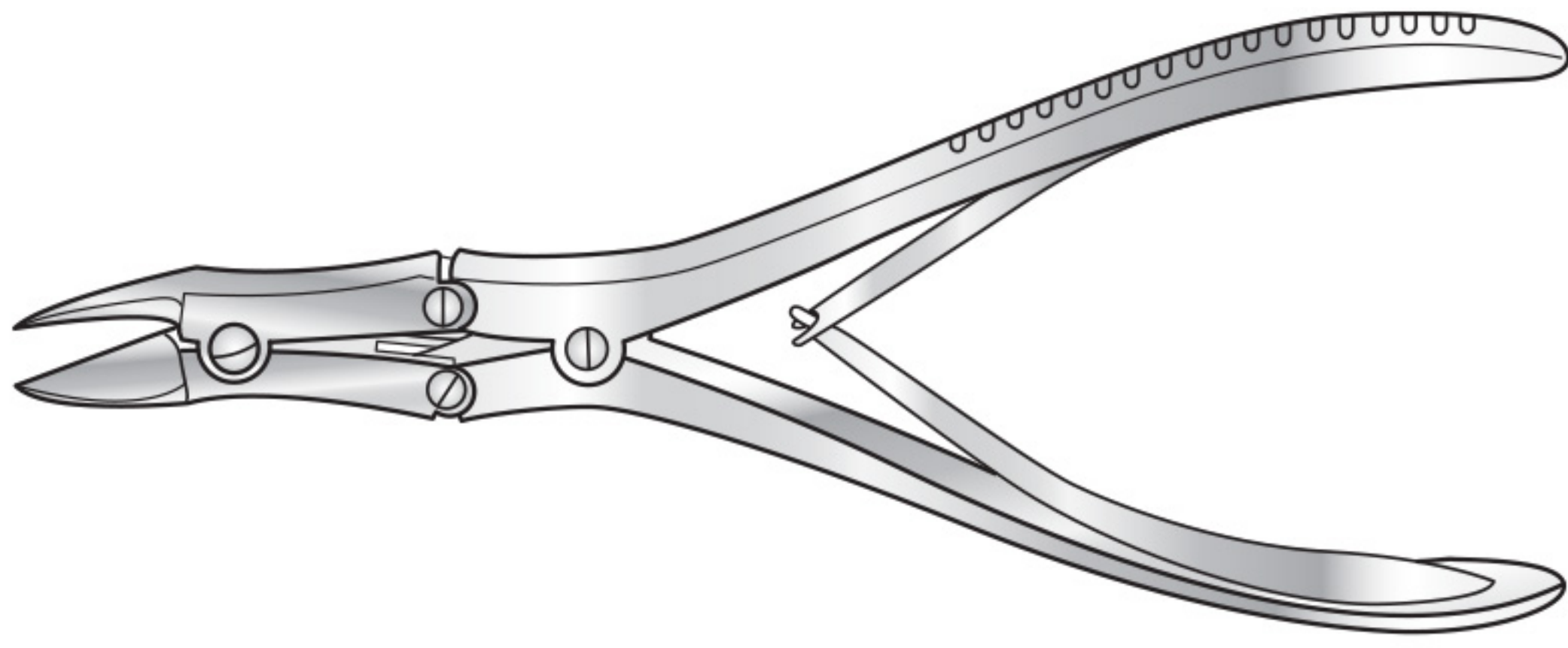

Code	Description
FST-6-101	165mm long
FST-6-102	191mm long

Liston Box Joint Bone Cutting Forcep

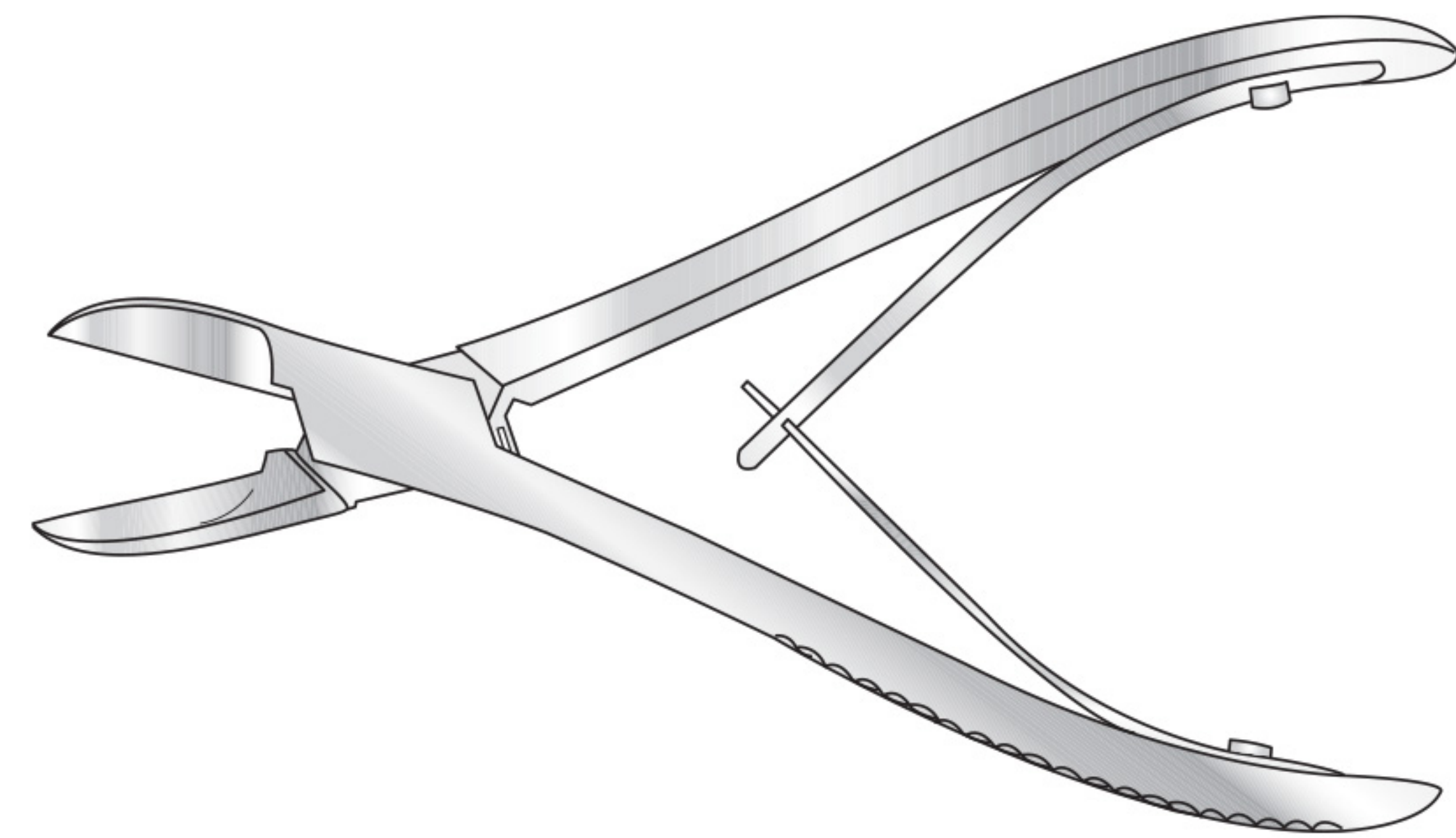

Straight

Code	Description
FST-6-103	140mm long
FST-6-104	200mm long
FST-6-105	220mm long

Angled

Code	Description
FST-6-106	170mm long
FST-6-107	220mm long

Liston Screw Joint Bone Cutting Forcep

With fluted handle

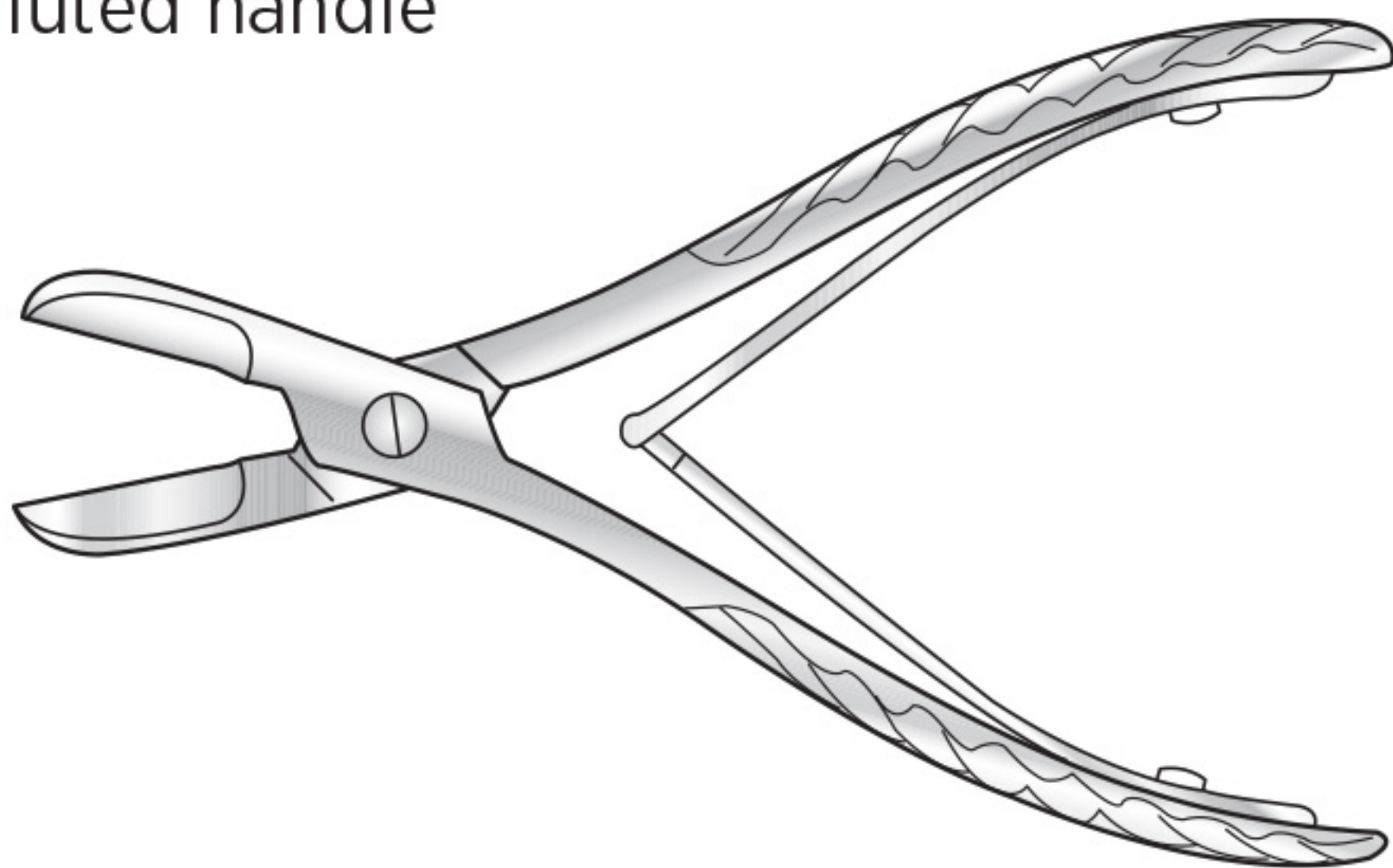

150mm long

Code	Description
FST-6-108	Straight
FST-6-109	Angled

200mm long

Code	Description
FST-6-110	Straight

180mm long

Code	Description
FST-6-111	Straight
FST-6-112	Angled

230mm long

Code	Description
FST-6-113	Straight

Screw Joint Bone Cutting Forcep

Straight

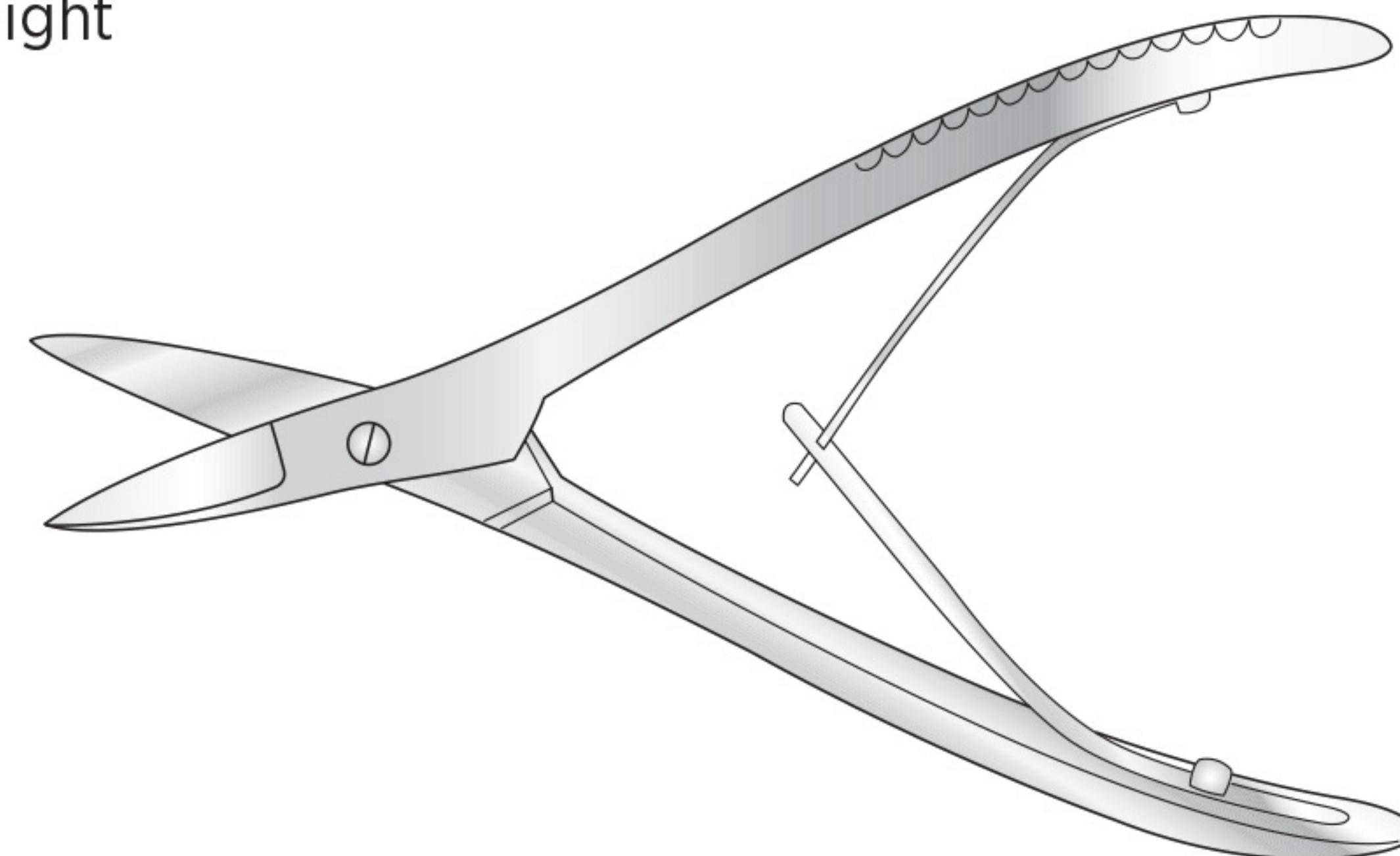

Code	Description
FST-6-114	160mm long

Liston Compound Action Bone Cutting Forcep

Straight, for heavy duty

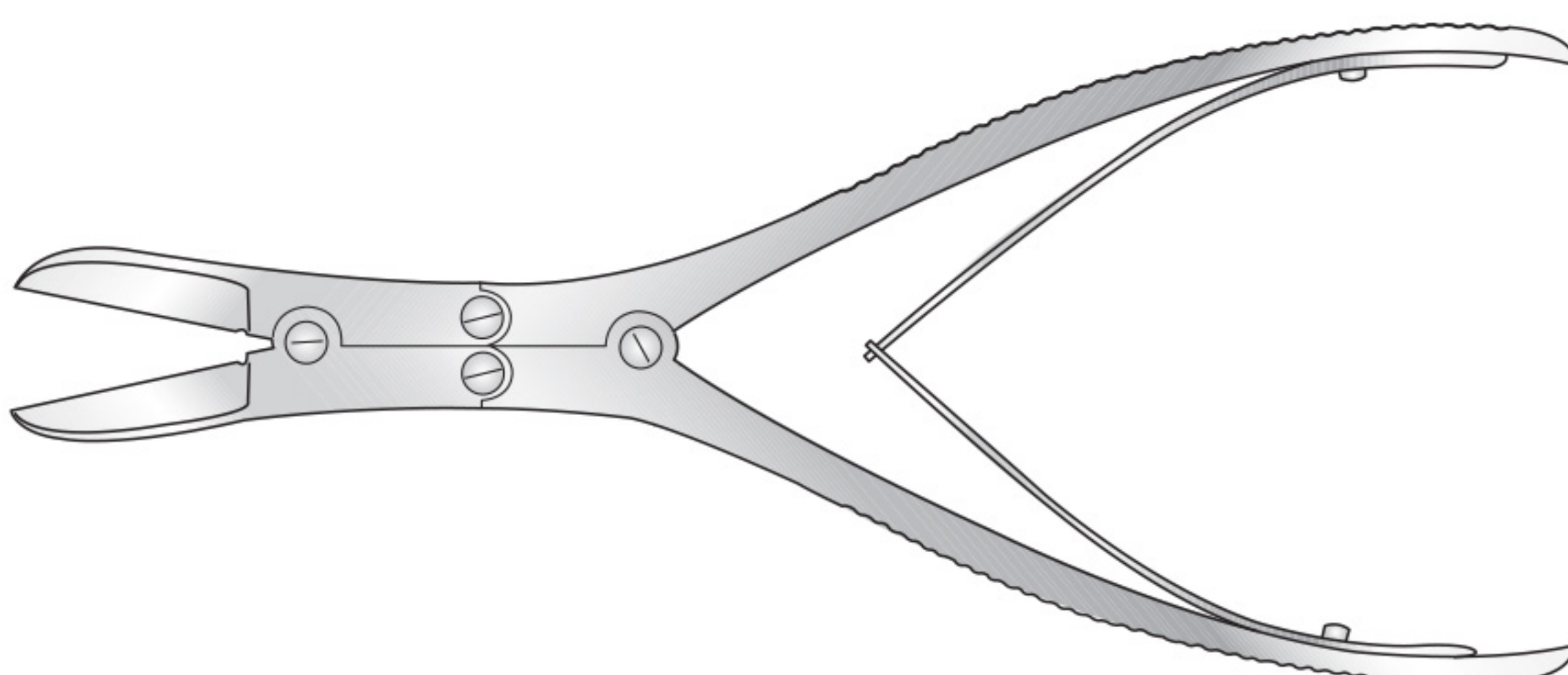

Code	Description
FST-6-115	305mm long
FST-6-116	300mm long
FST-6-117	190mm long

Ruskin-Liston Bone Cutting Forcep

Compound action, fine

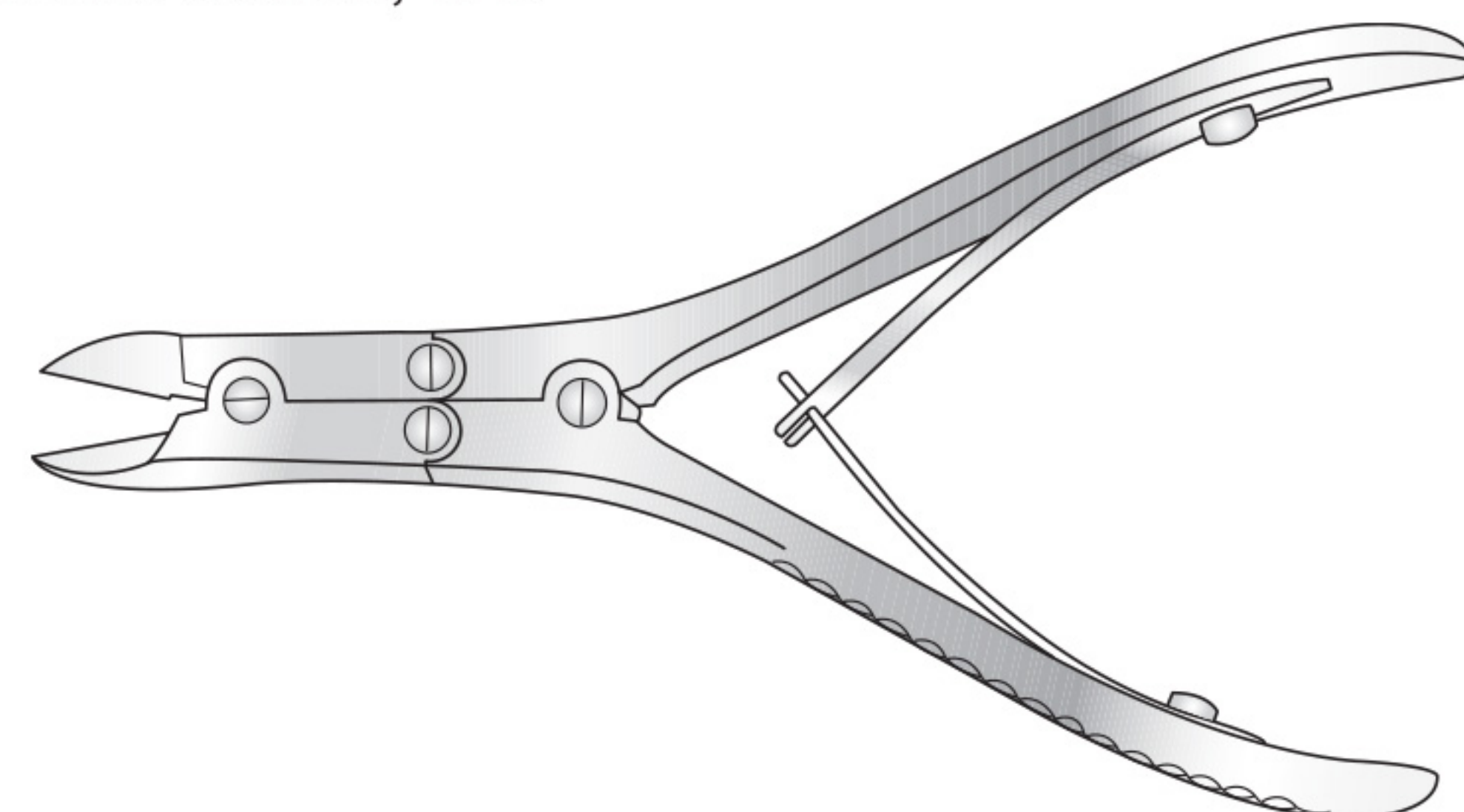

Straight

Code	Description
FST-6-118	140mm long
FST-6-119	145mm long
FST-6-120	190mm long

Angled

Code	Description
FST-6-121	190mm long

Ward Bone Cutting Forceps

Slightly angled on flat

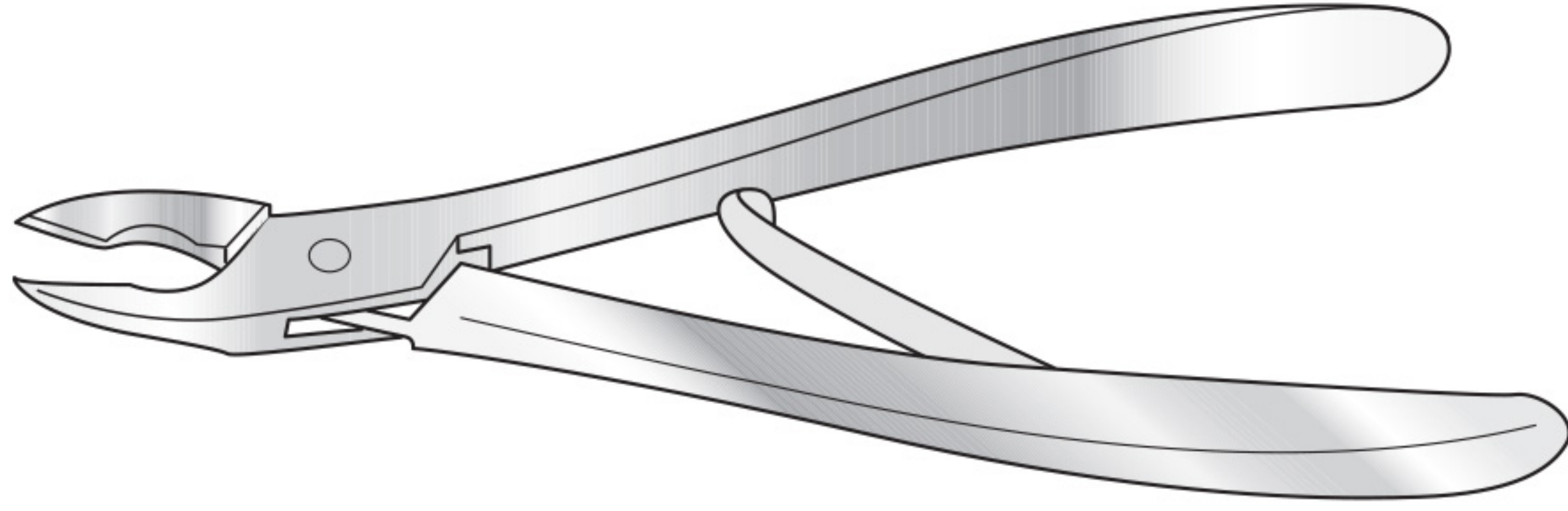

Code	Description
FST-6-130	180mm long

Kleinert Kutz Bone Rongeur

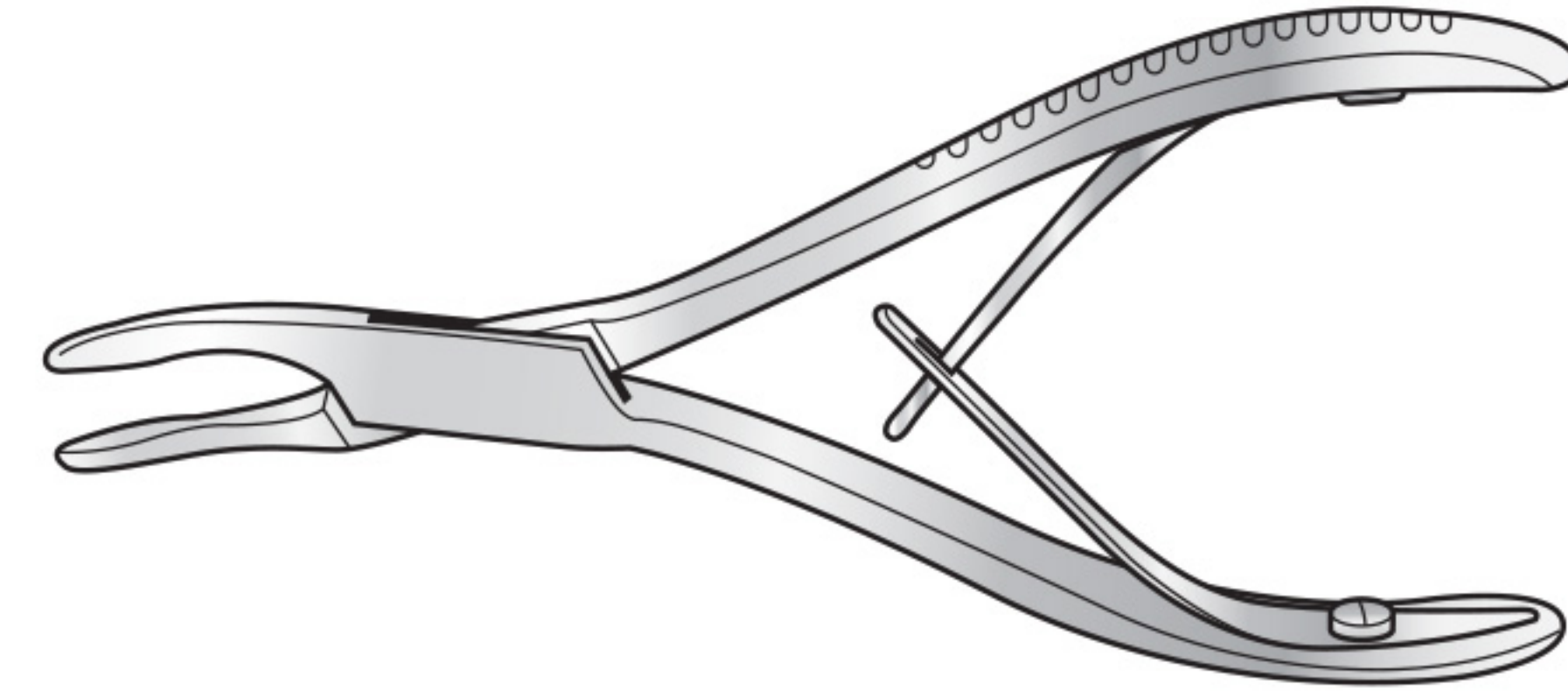

Code	Description
FST-6-131	Curved, 140mm, width 2mm
FST-6-132	Curved, 155mm, width 2mm
FST-6-133	Curved, 155mm, width 3mm

Horsley Compound Action Bone Cutter

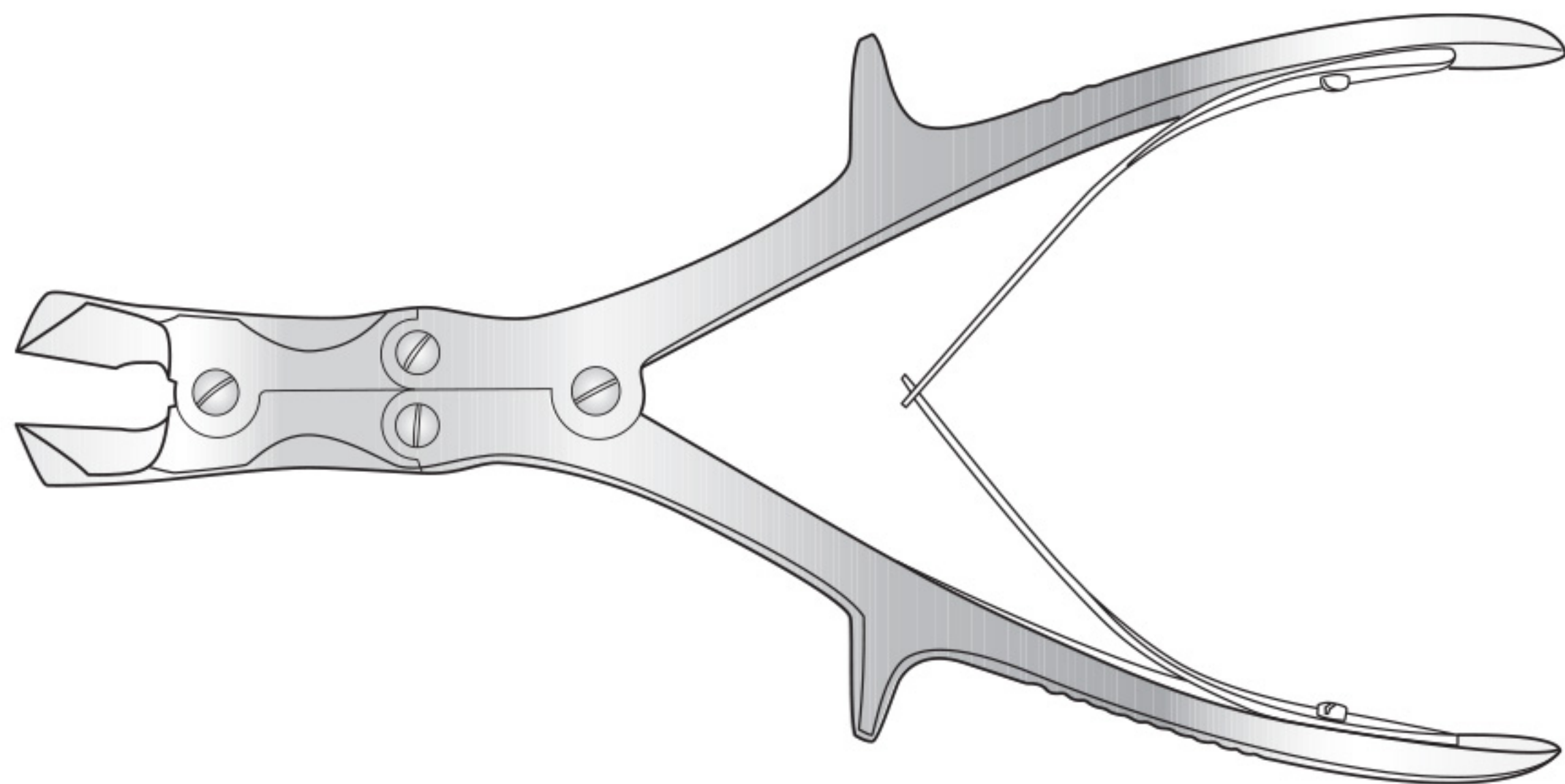

Code	Description
FST-6-134	235mm long

Kleinert Kutz Skin Hooks



Code	Description
FST-6-135	16cm large
FST-6-136	16cm medium
FST-6-137	16cm small

Stamms Box Joint Bone Cutter

Standard, stainless steel

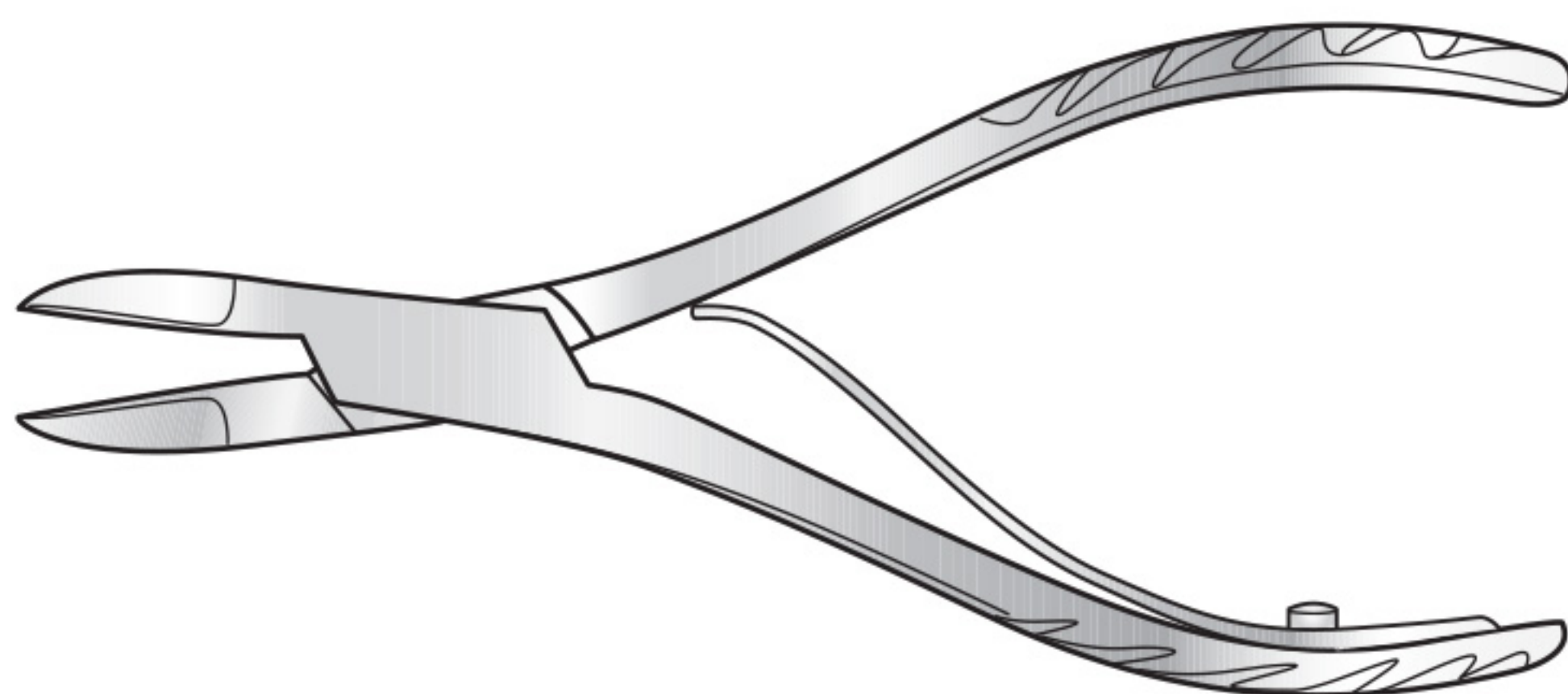

Code	Description
FST-6-138	140mm long

Bone Rongeurs

Echlin Compound Action Bone Rongeur

Straight, with or without horn, 230mm long

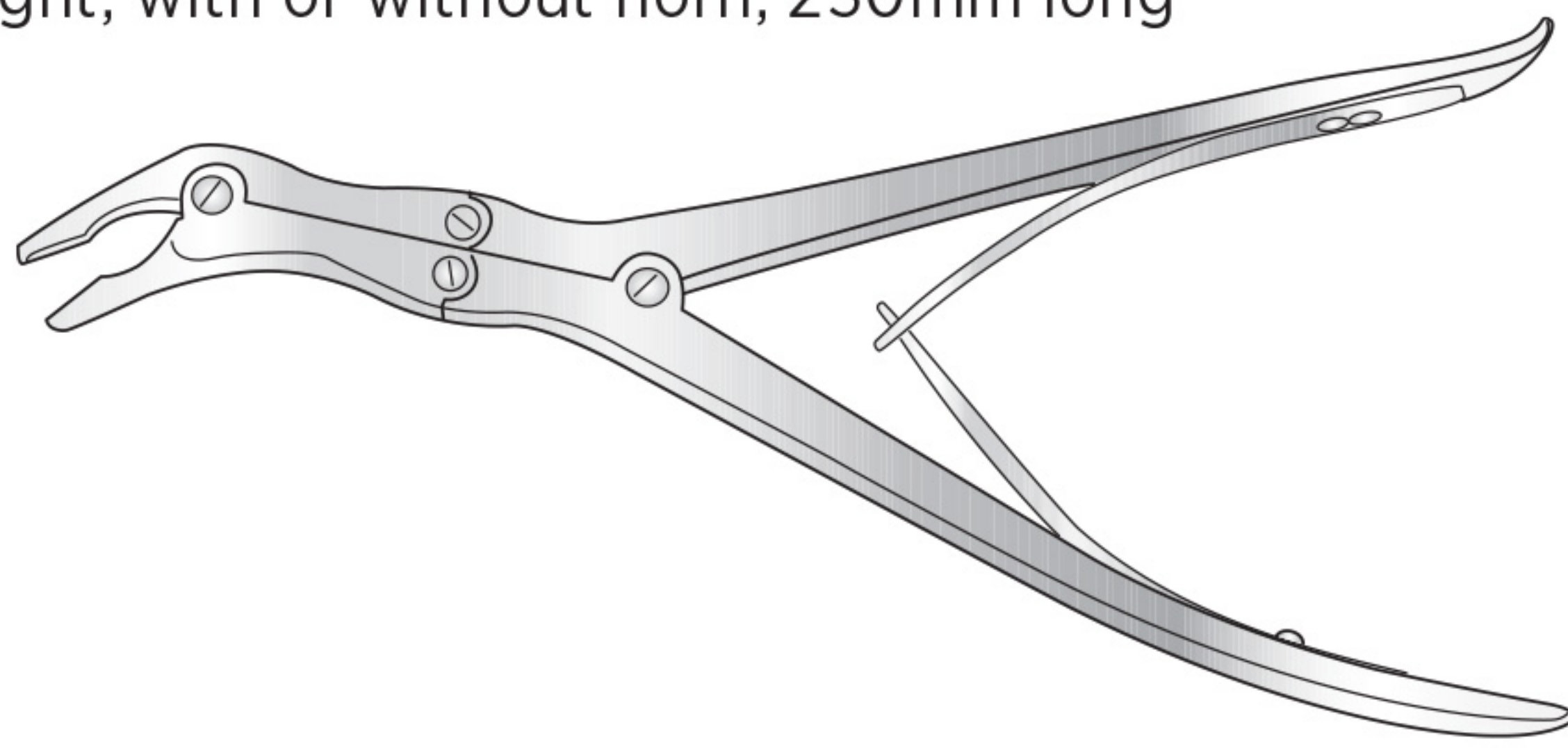

Code	Description
FST-6-150	Width 2mm
FST-6-151	Width 3mm
FST-6-152	Width 4mm

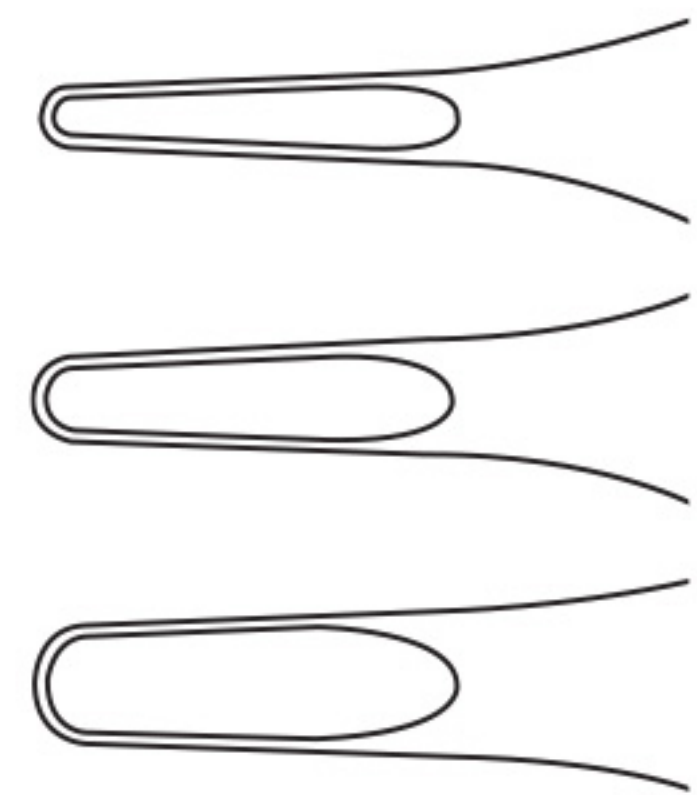

Stille Compound Action Bone Rongeur

Angled to side, 240mm long



Code	Description
FST-6-153	11mm bite

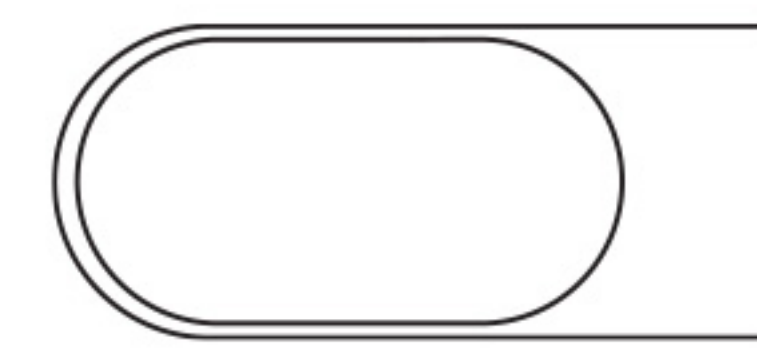

Leksell Compound Action Bone Rongeur

250mm long

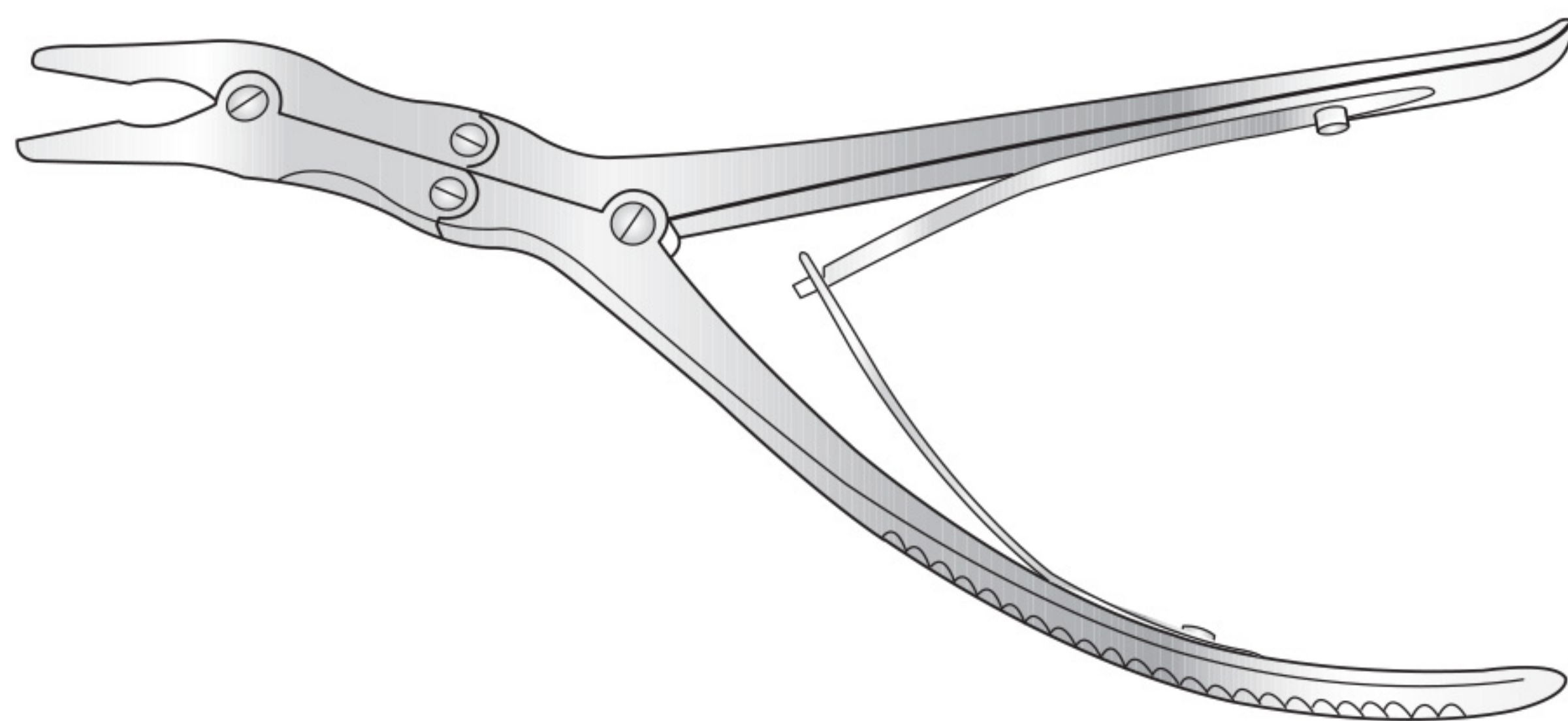

Code	Description
FST-6-154	3mm bite
FST-6-155	5mm bite
FST-6-156	8mm bite

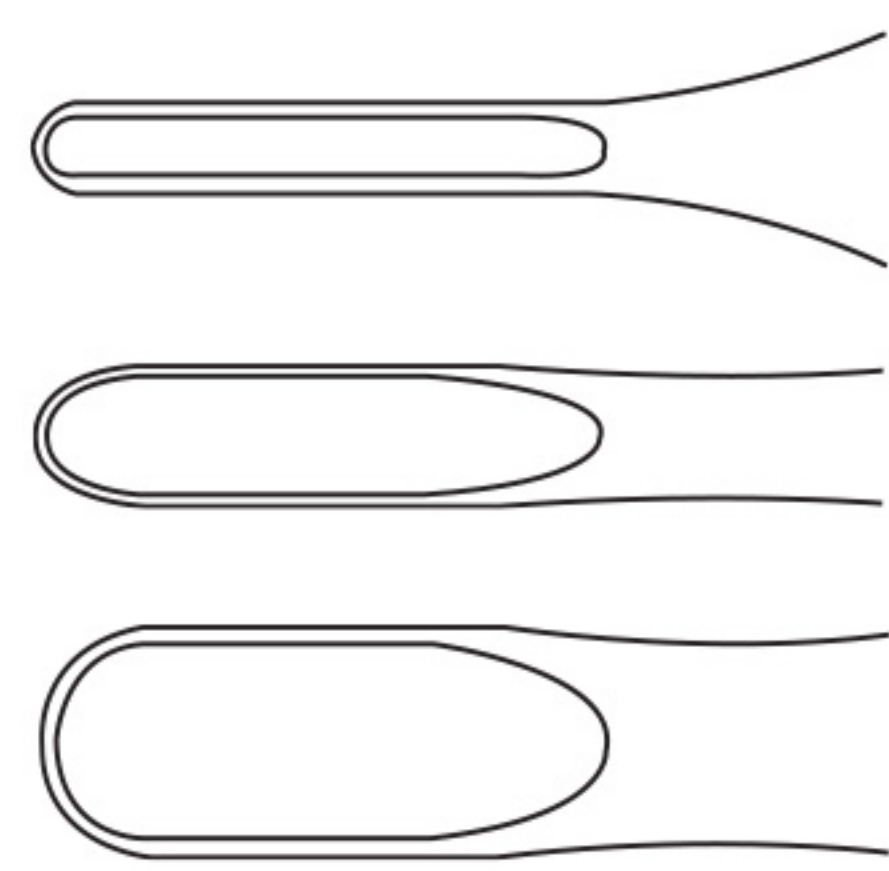

Leksell Stille Compound Action Bone Rongeur

240mm long

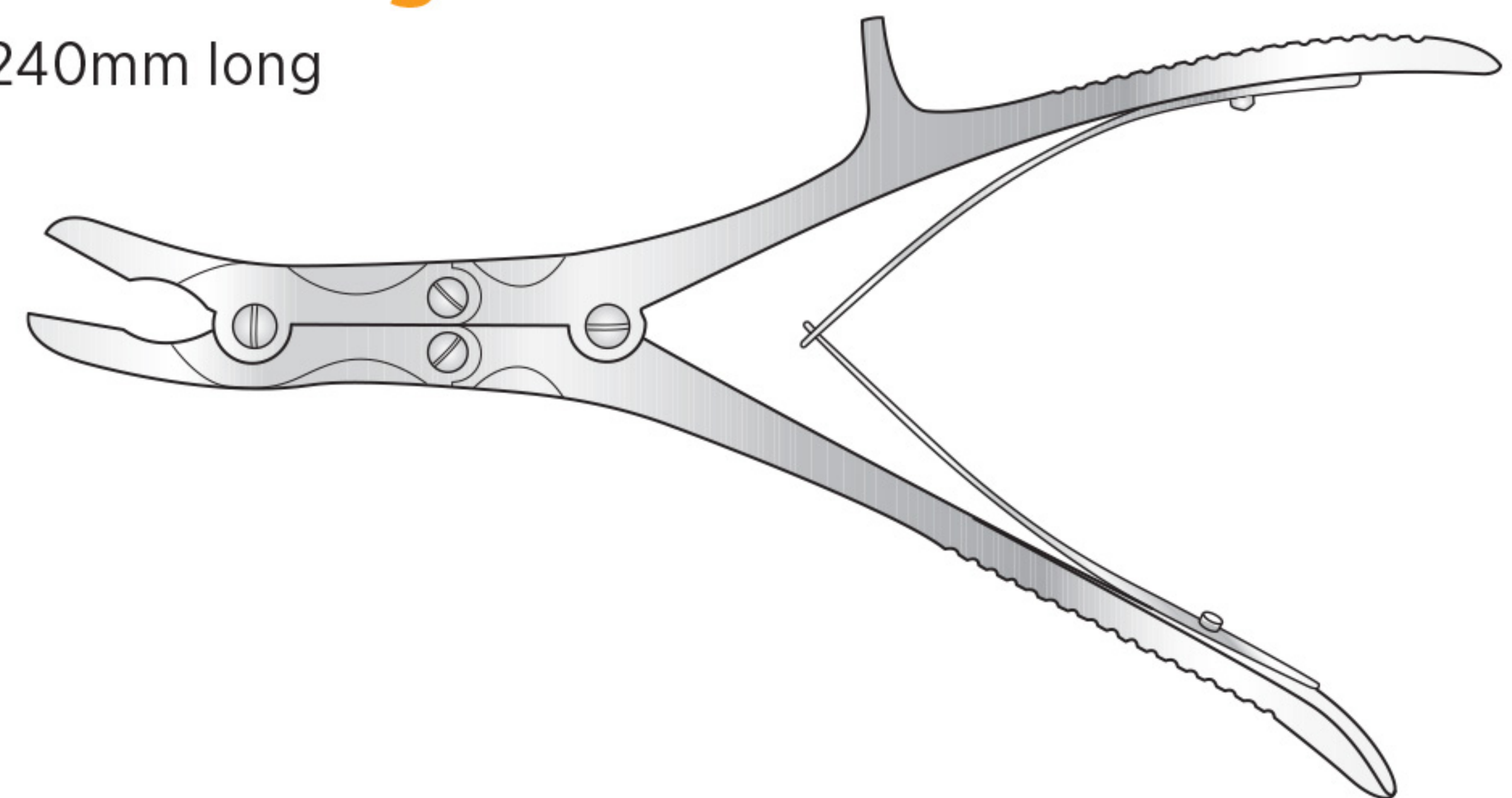

Code	Description
FST-6-157	8mm bite



Leksell Compound Action Bone Rongeur

240mm long

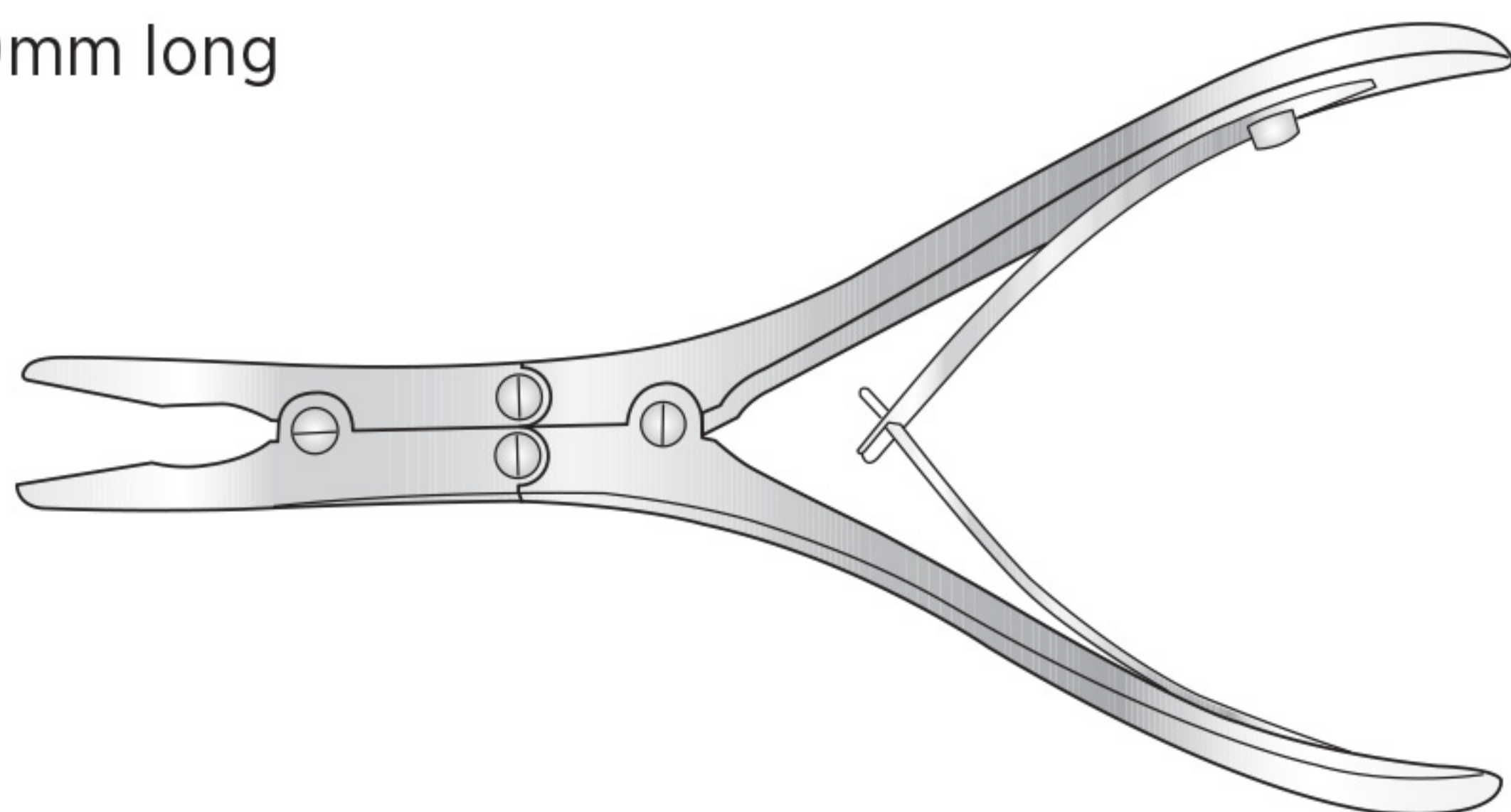

Code	Description
FST-6-158	Width 3mm

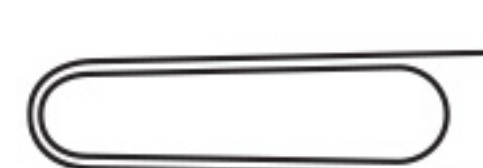

Luer Stille Compound Action Bone Rongeur

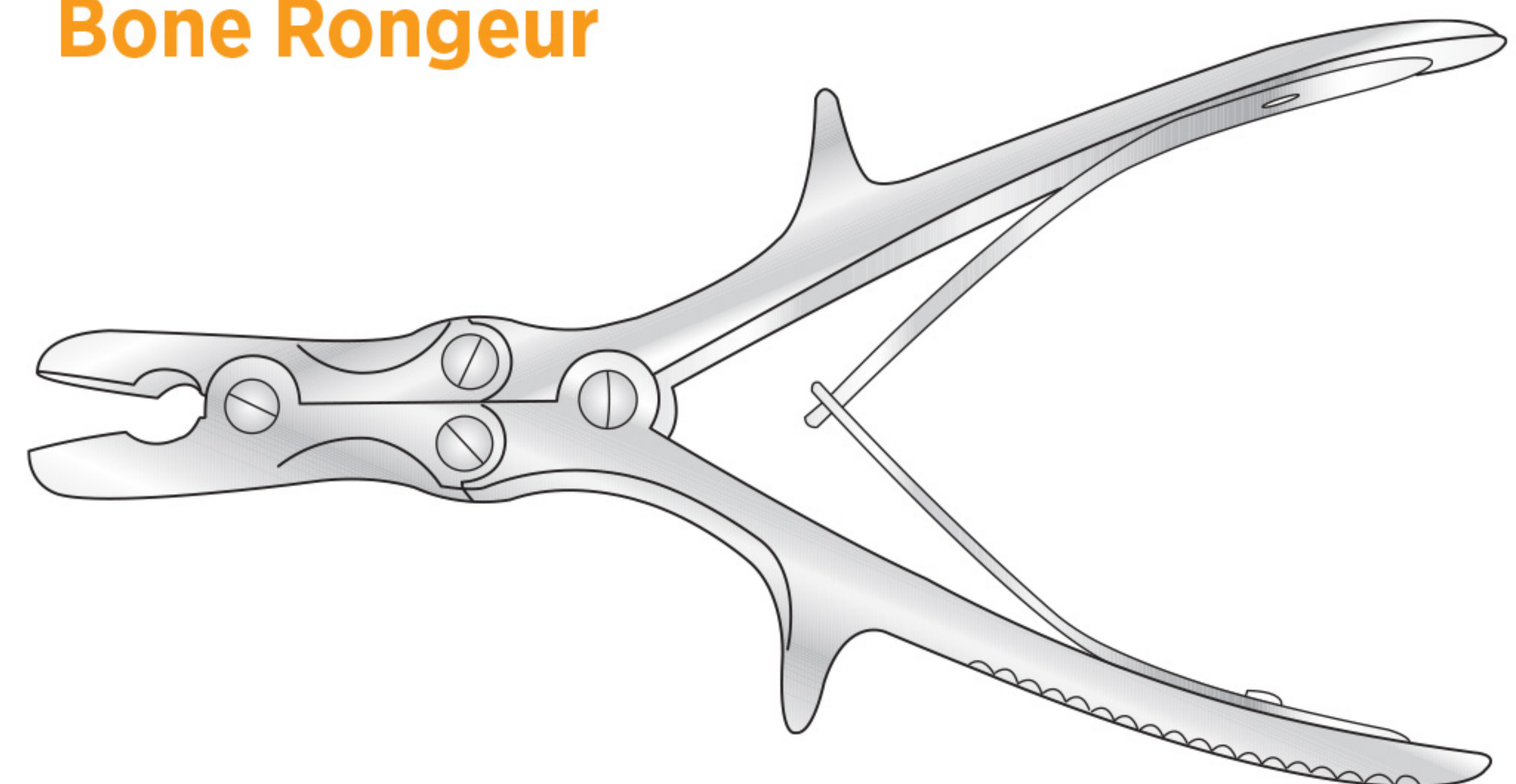

Straight

Code	Description
FST-6-159	10mm bite, 220mm long
FST-6-160	12mm bite, 260mm long

Curved

Code	Description
FST-6-161	10mm bite, 220mm long
FST-6-162	11mm bite, 230mm long

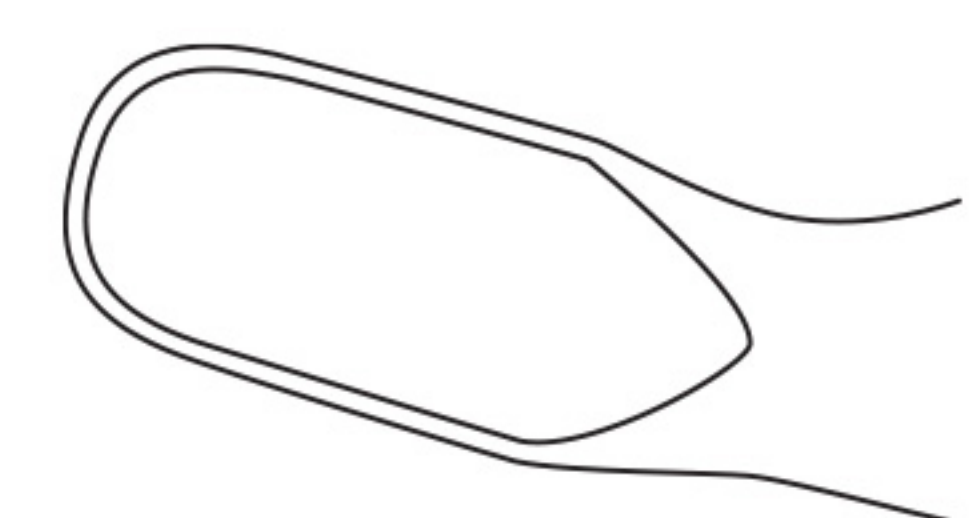

Luer Compound Action Bone Rongeur

6mm bite, 190mm long

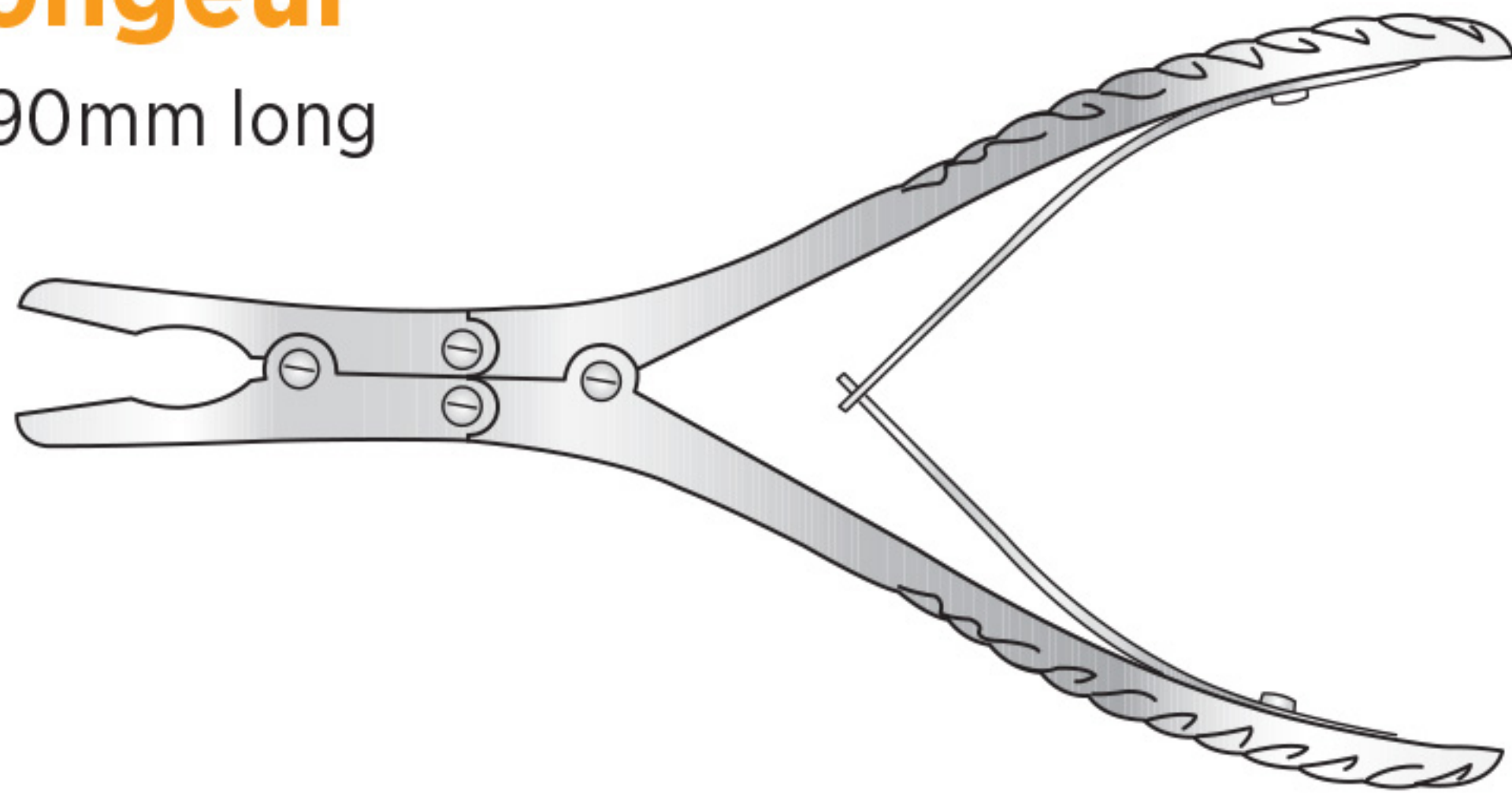

Code	Description
FST-6-170	Straight
FST-6-171	Curved

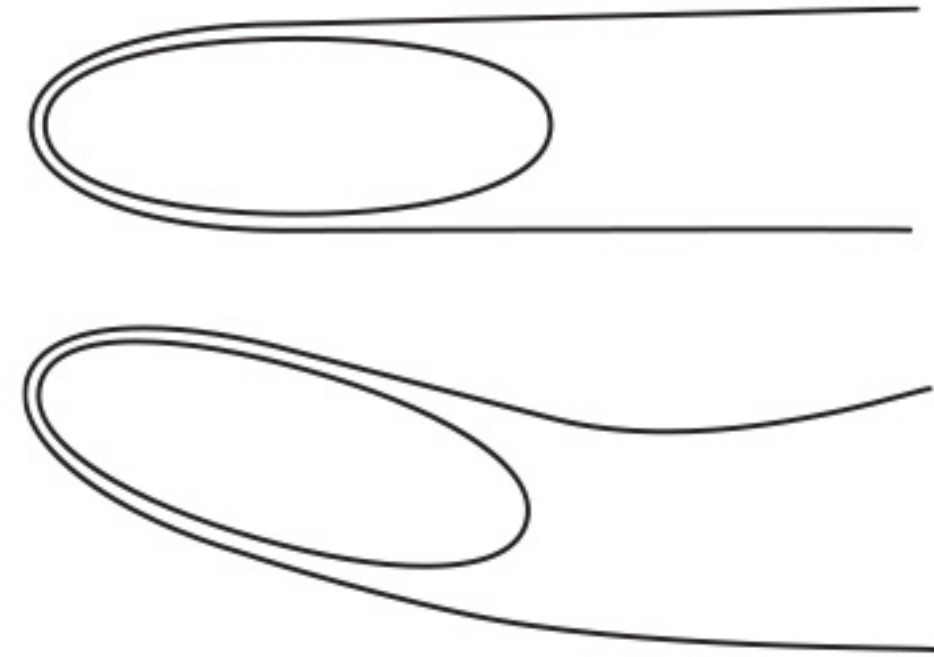

Ruskin Compound Action Bone Rongeur

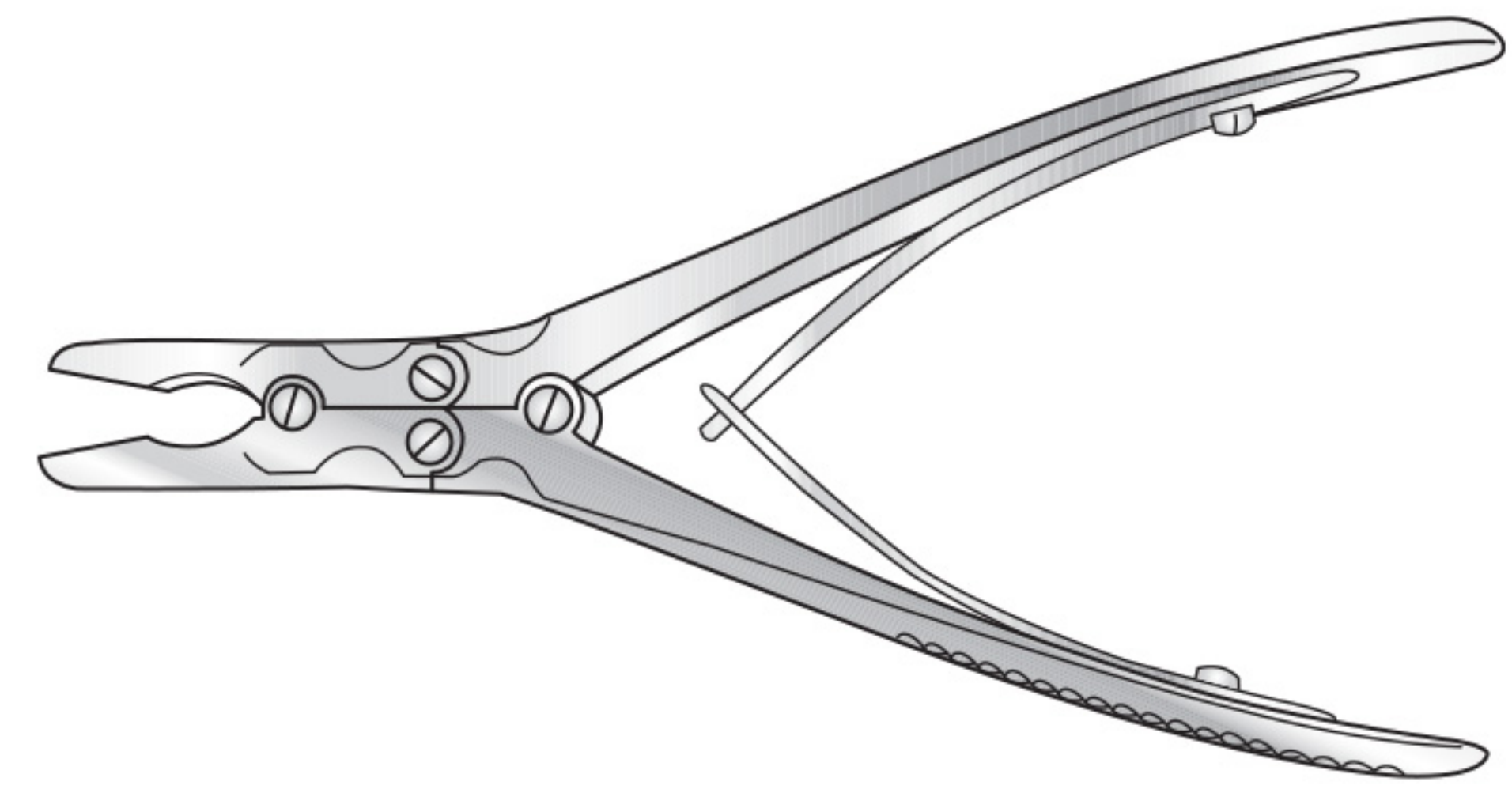

3mm bite, 150mm long

Code	Description
FST-6-172	Straight
FST-6-173	Curved

4mm bite, 185mm long

Code	Description
FST-6-174	Straight
FST-6-175	Curved

Luer Box Joint Bone Rongeur

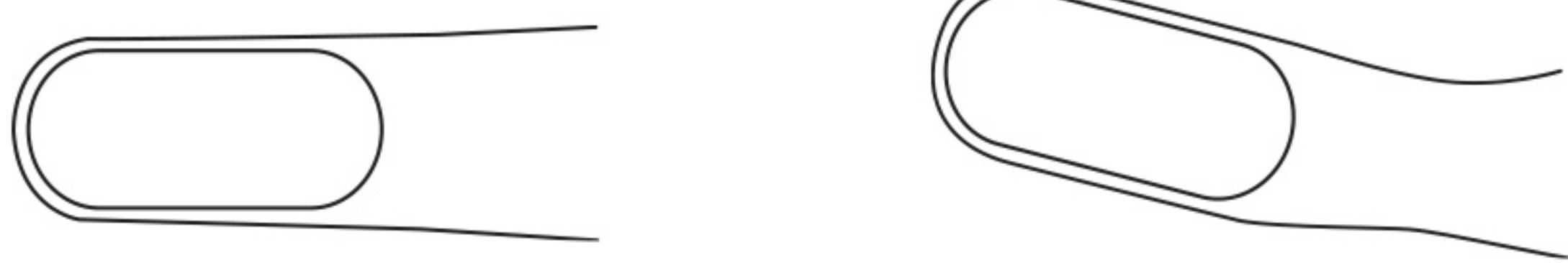
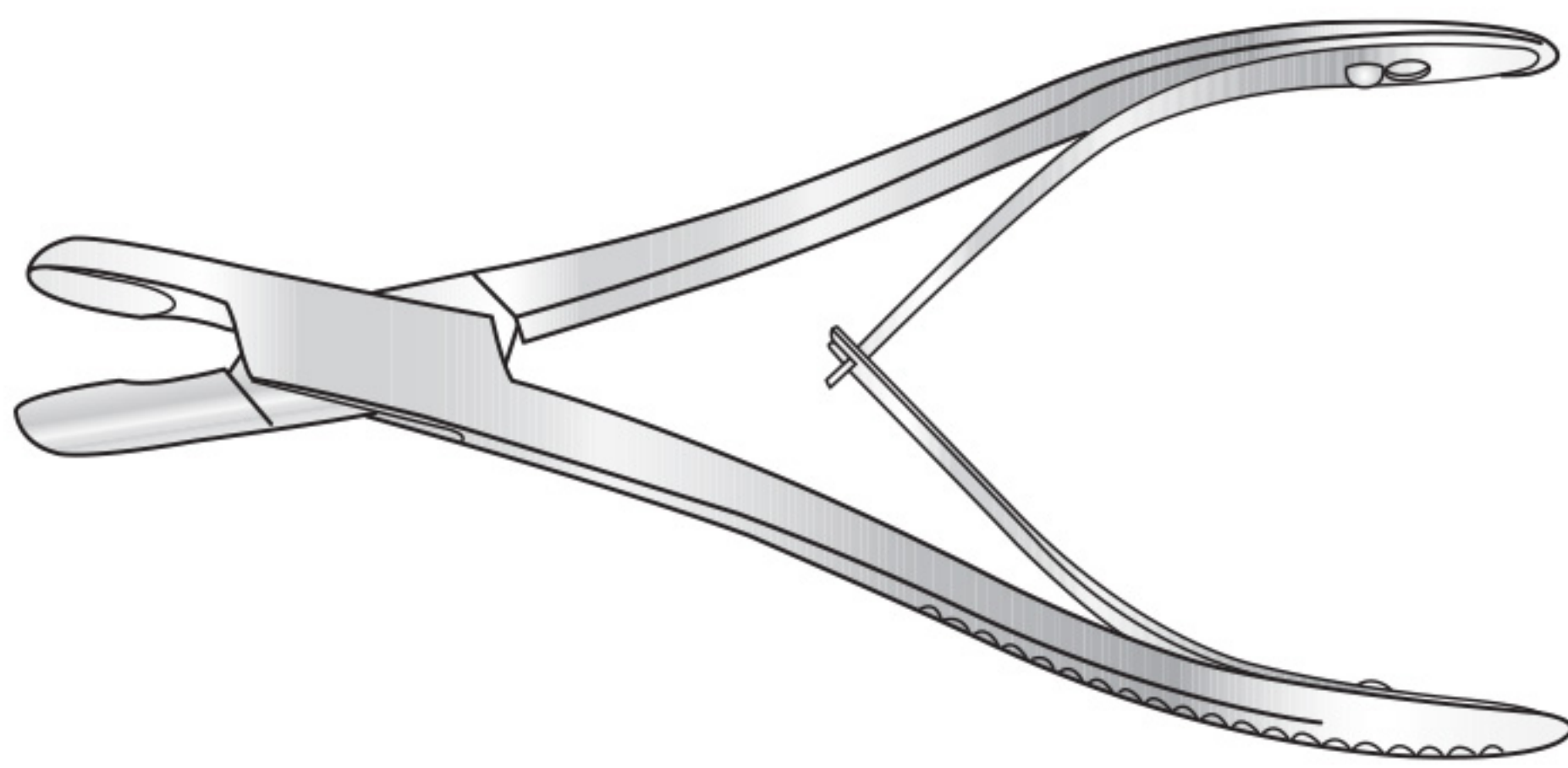

Straight, 185mm long

Code	Description
FST-6-176	8mm bite
FST-6-177	10mm bite

Curved, 210mm long

Code	Description
FST-6-178	8mm bite

Compound Action Bone Rongeur

Lightweight pattern, curved, 150mm long

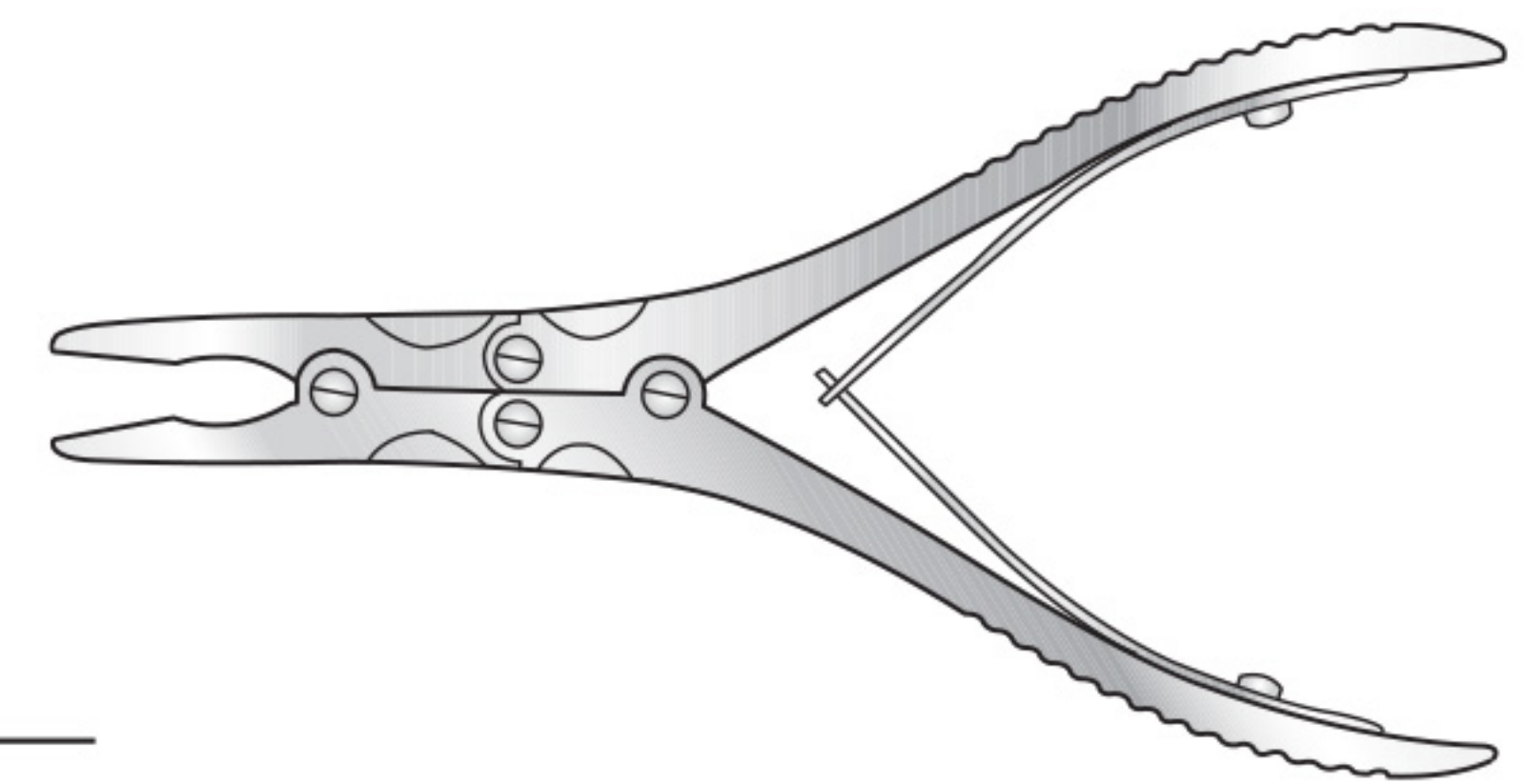

Code	Description
FST-6-179	4mm bite

Cushing Screw Joint Bone Rongeur

190mm long

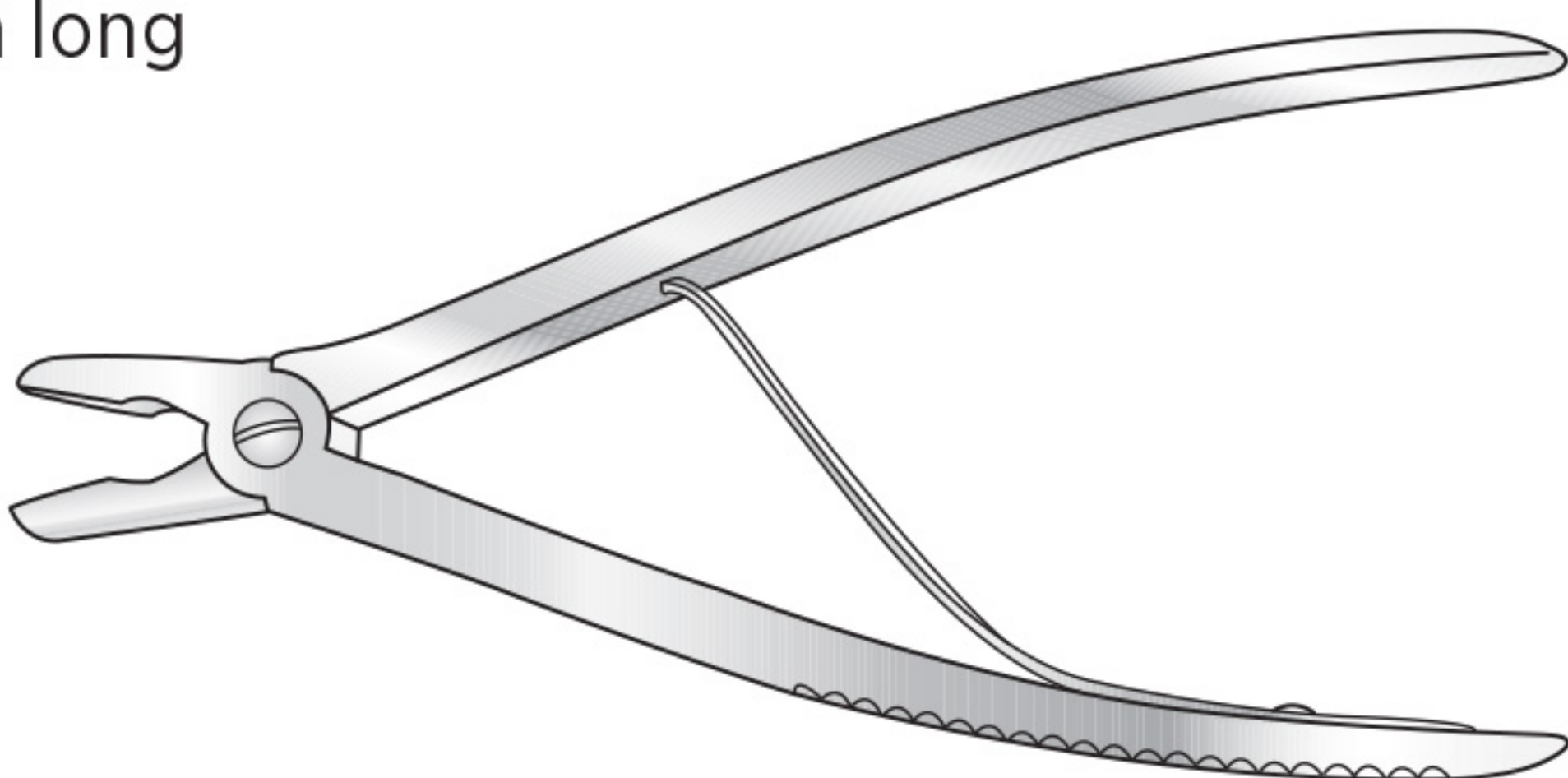

Straight

Code	Description
FST-6-180	4mm bite
FST-6-181	6mm bite
FST-6-182	8mm bite

Curved

Code	Description
FST-6-183	4mm bite
FST-6-184	6mm bite
FST-6-185	8mm bite

Lempert Box Joint Bone Rongeur

3mm bite, 155mm long

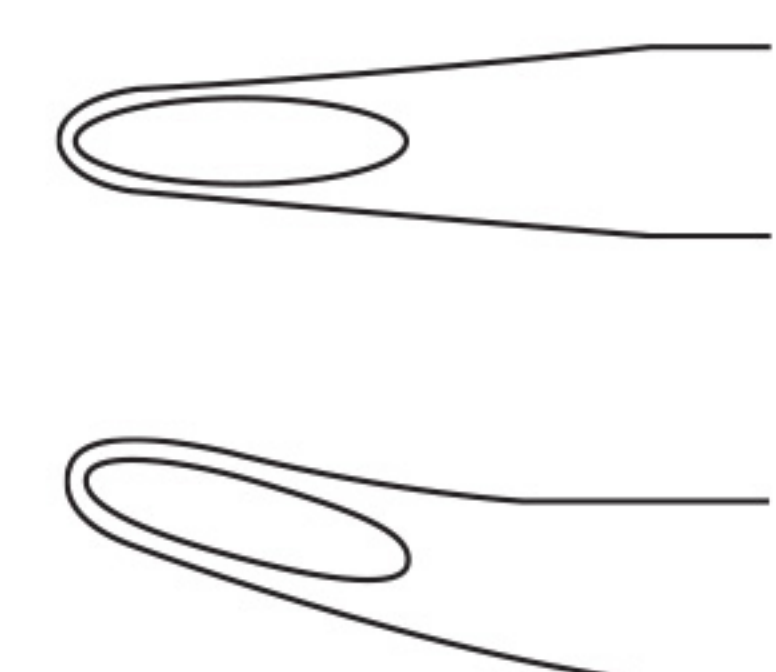
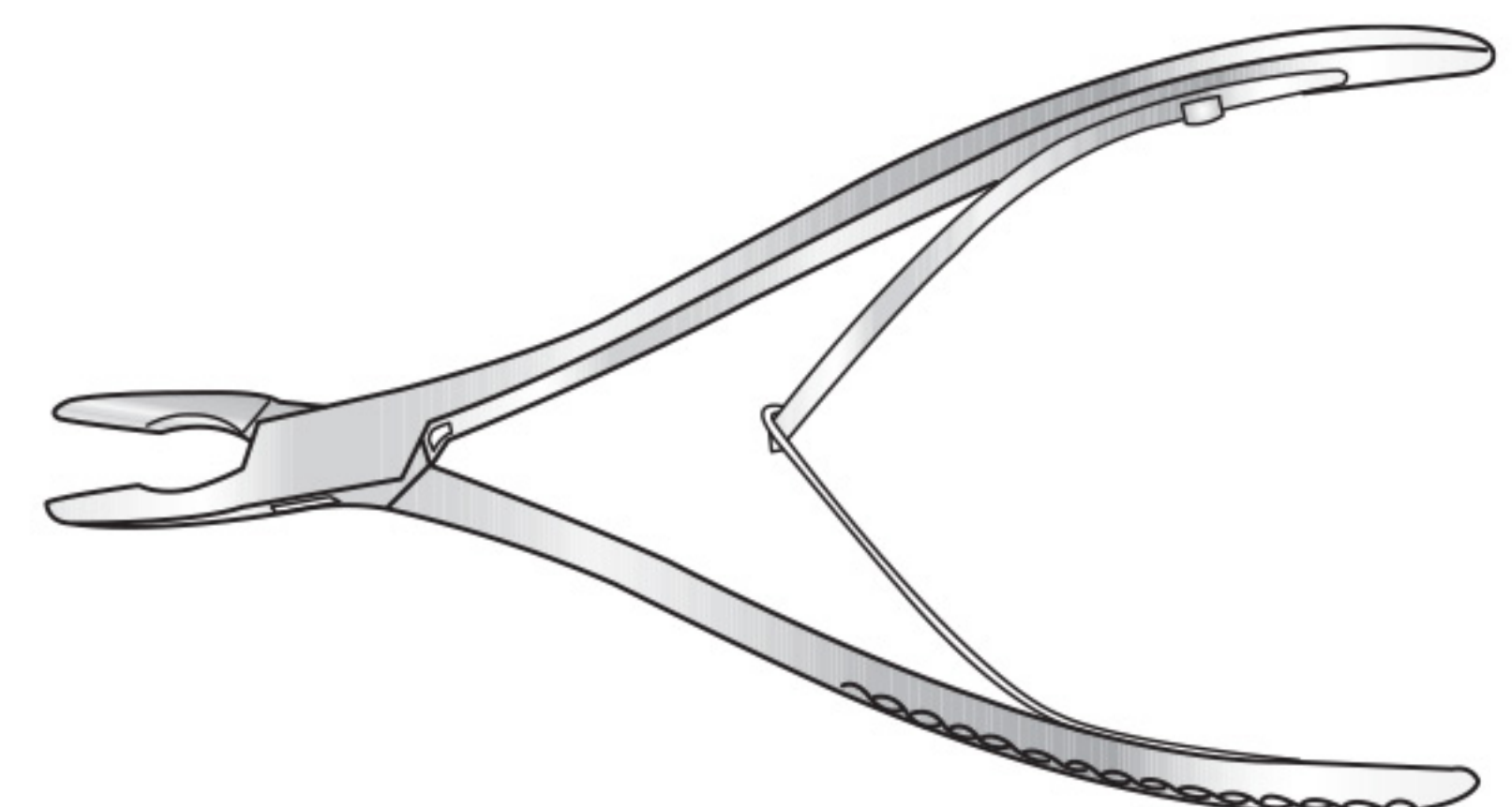

Code	Description
FST-6-186	Straight
FST-6-187	Curved

Bone Holding Forceps

Lambotte Bone Holding Forceps

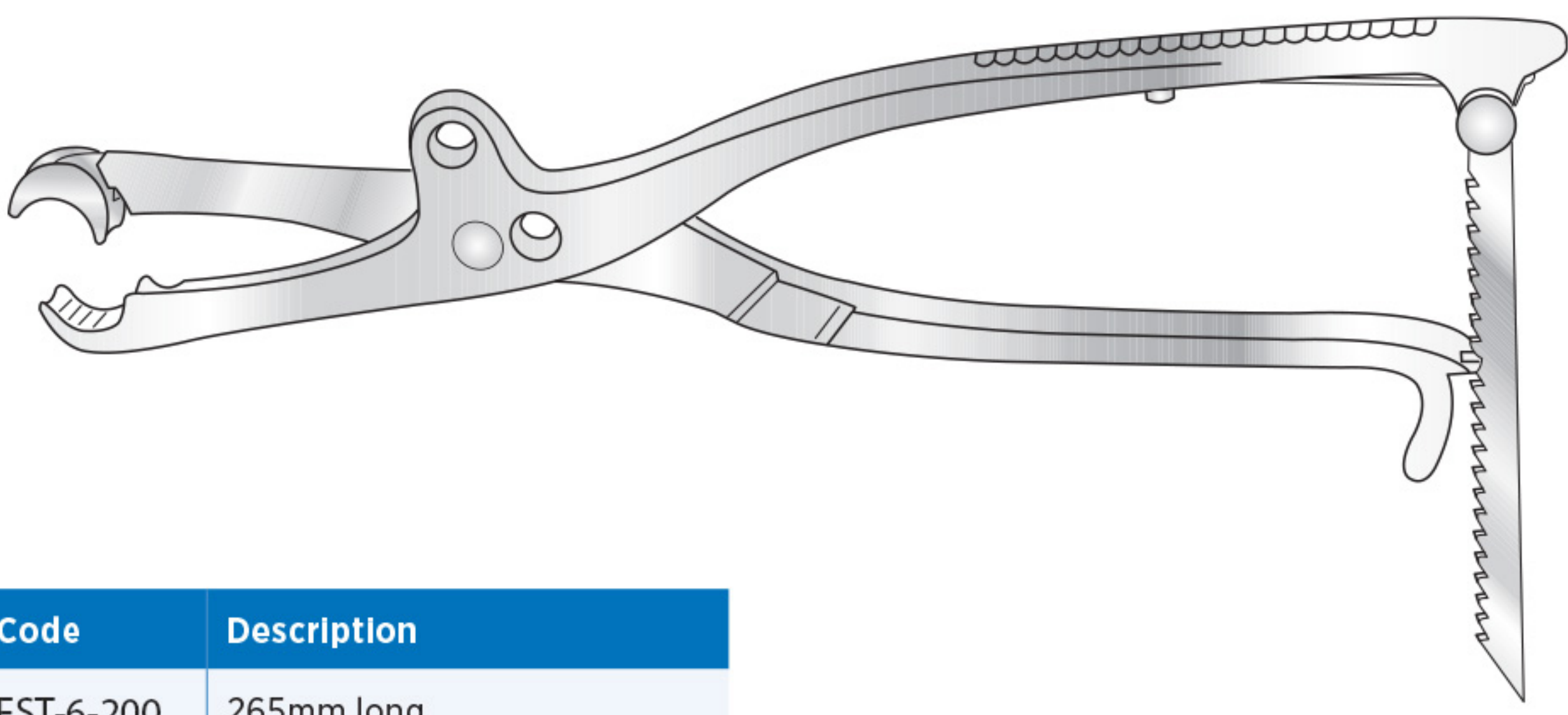

Code	Description
FST-6-200	265mm long

Bone Holding Forceps

Screw joint, with holding screw

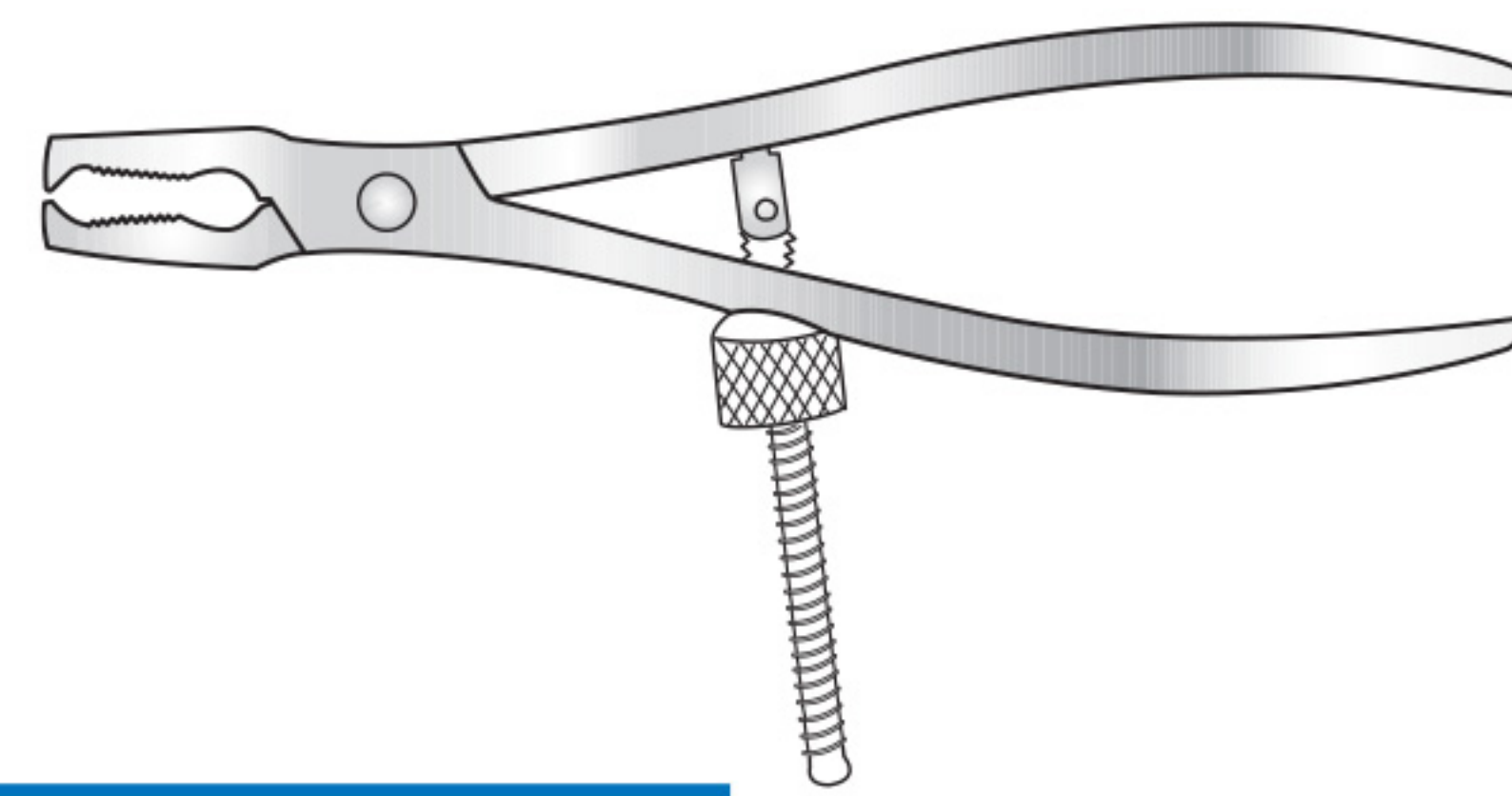

Code	Description
FST-6-201	165mm long

Lambotte Bone Holding Forceps

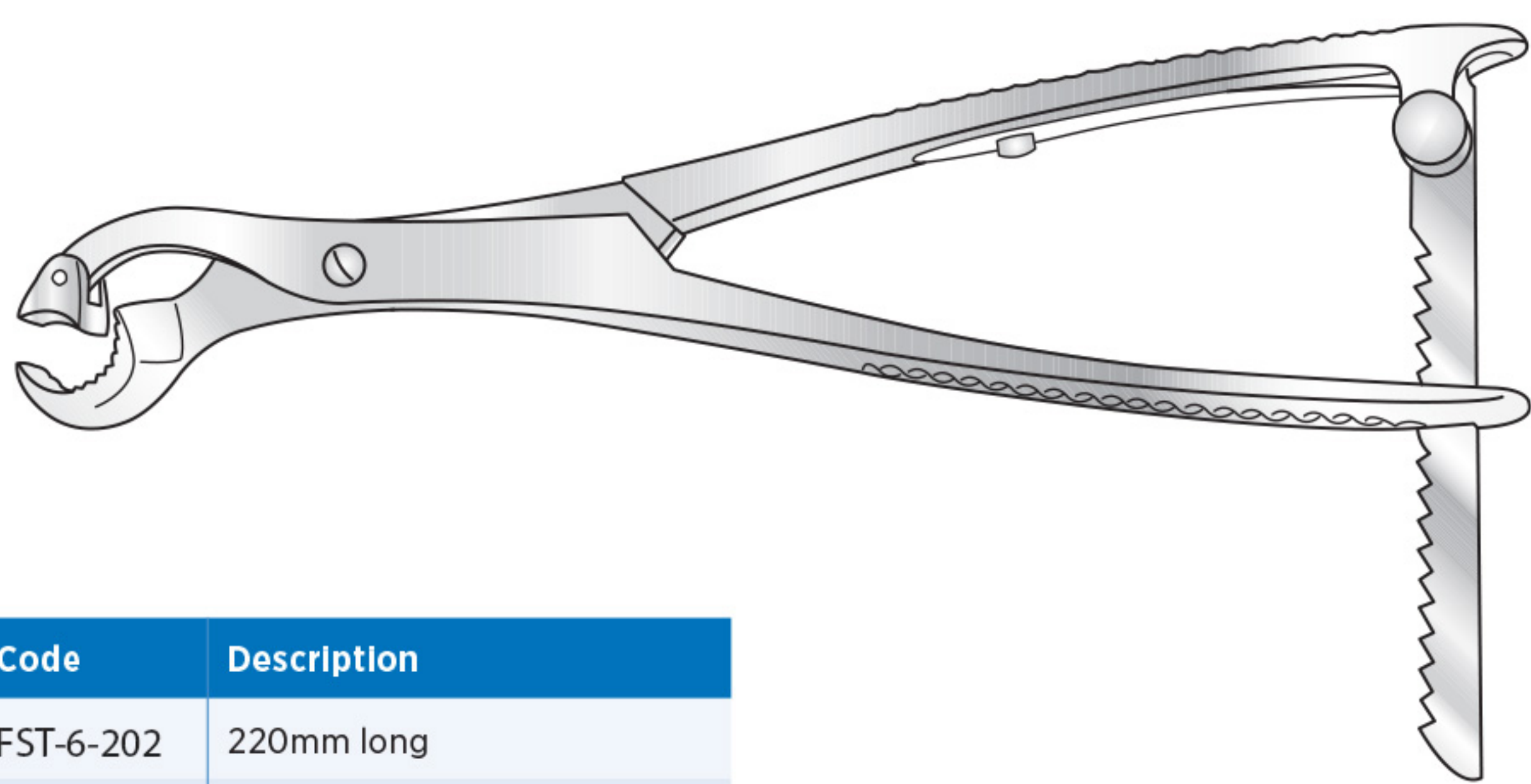

Code	Description
FST-6-202	220mm long
FST-6-203	215mm long
FST-6-204	330mm long

Hey Groves Bone Holding Forceps

With screw locking device



Code	Description
FST-6-205	200mm long
FST-6-206	225mm long
FST-6-207	305mm long

Farabeuf Bone Holding Forceps

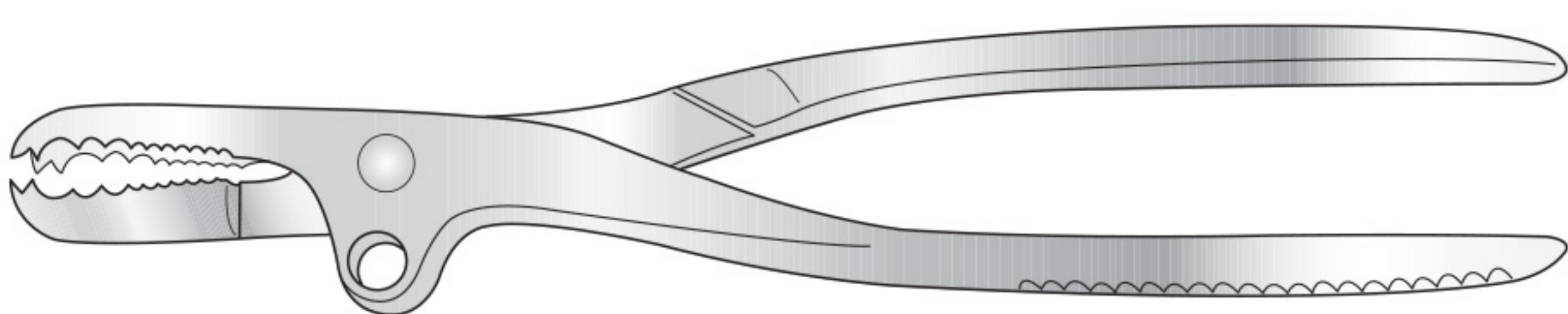

Code	Description
FST-6-208	230mm long
FST-6-209	250mm long

Bone Holding Forceps

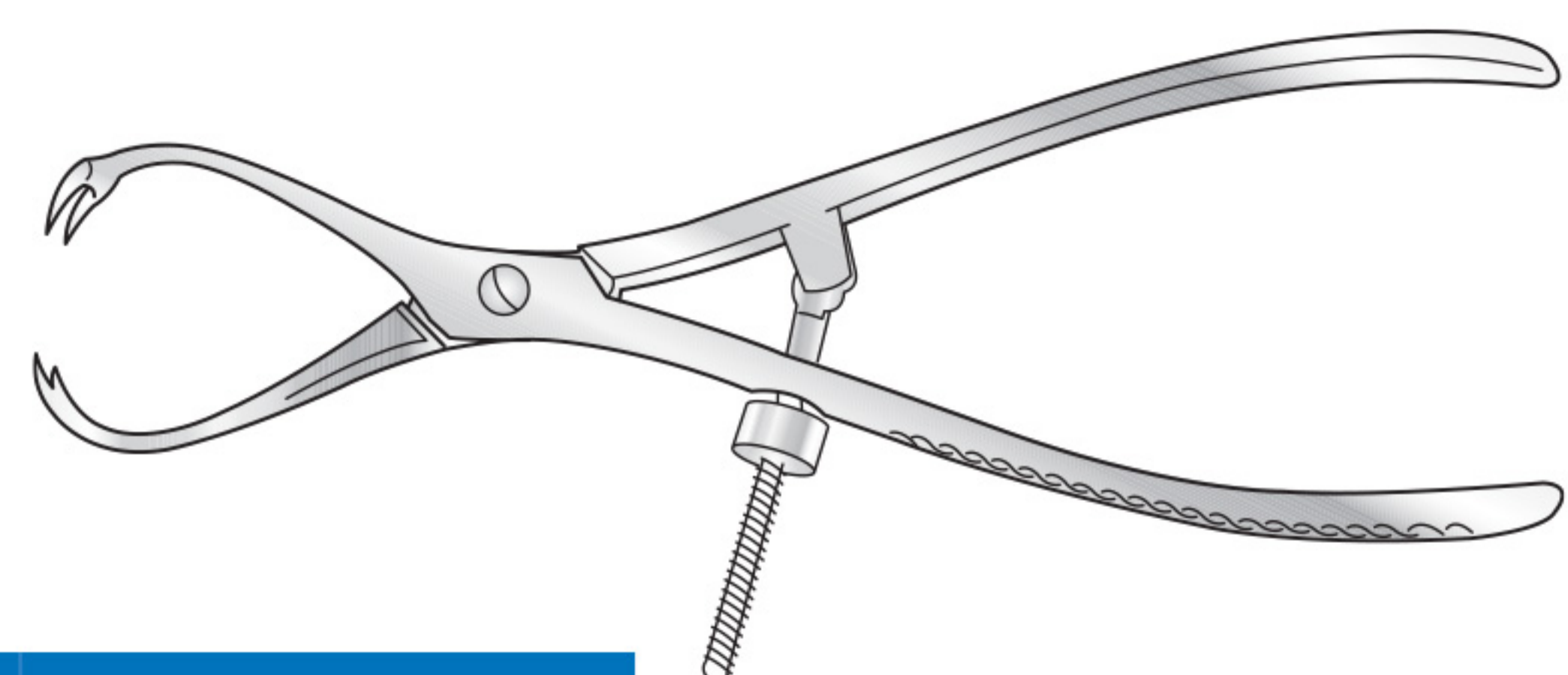

Code	Description
FST-6-210	140mm long
FST-6-211	185mm long
FST-6-212	215mm long
FST-6-213	275mm long

Farabeuf-Lambotte Bone Holding Forceps

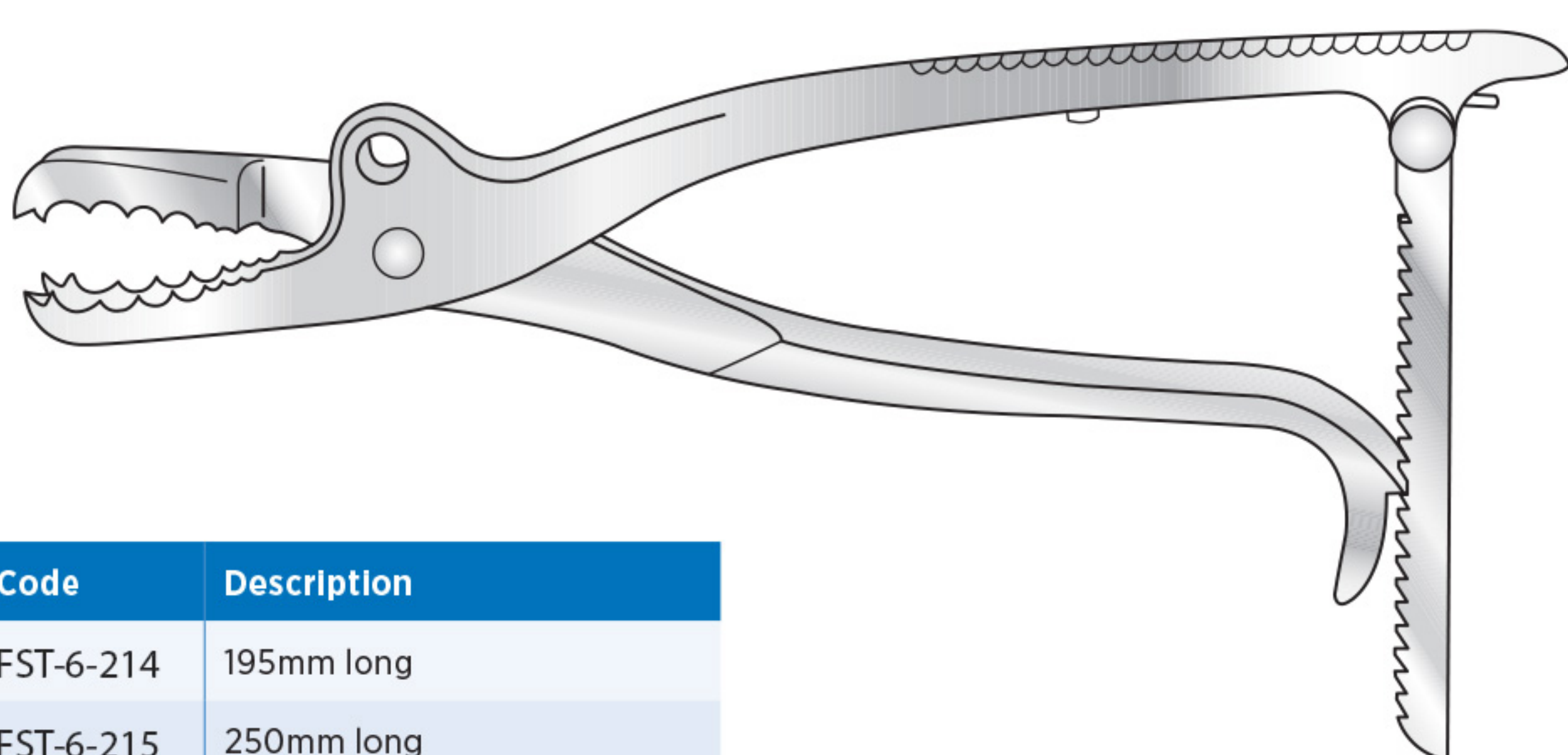

Code	Description
FST-6-214	195mm long
FST-6-215	250mm long
FST-6-216	260mm long

Fergusson Bone Holding Forceps

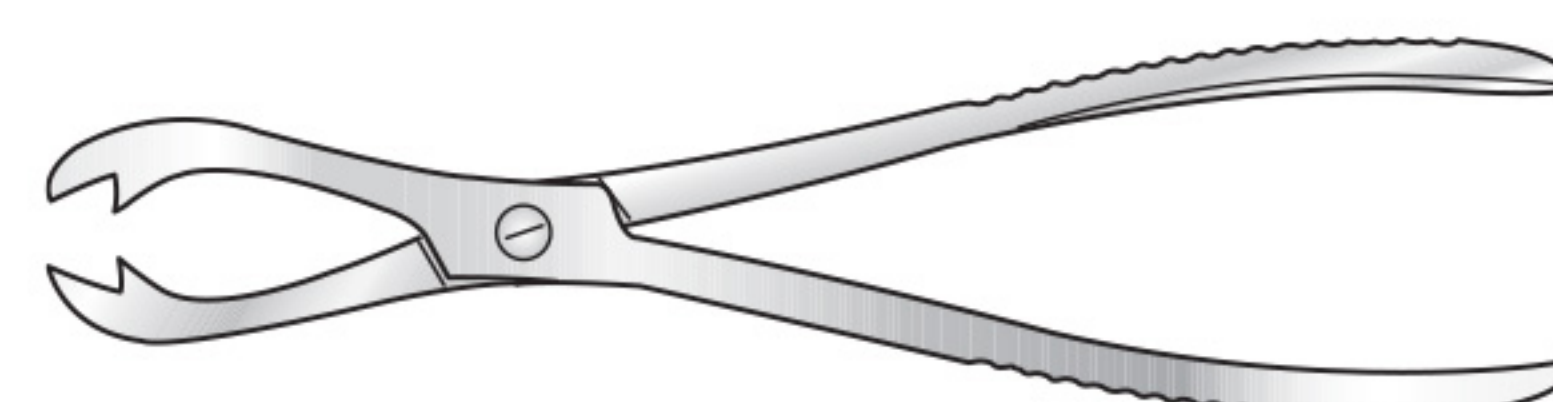

Code	Description
FST-6-217	150mm long
FST-6-218	200mm long
FST-6-219	230mm long

Frosch Bone Holding Forceps

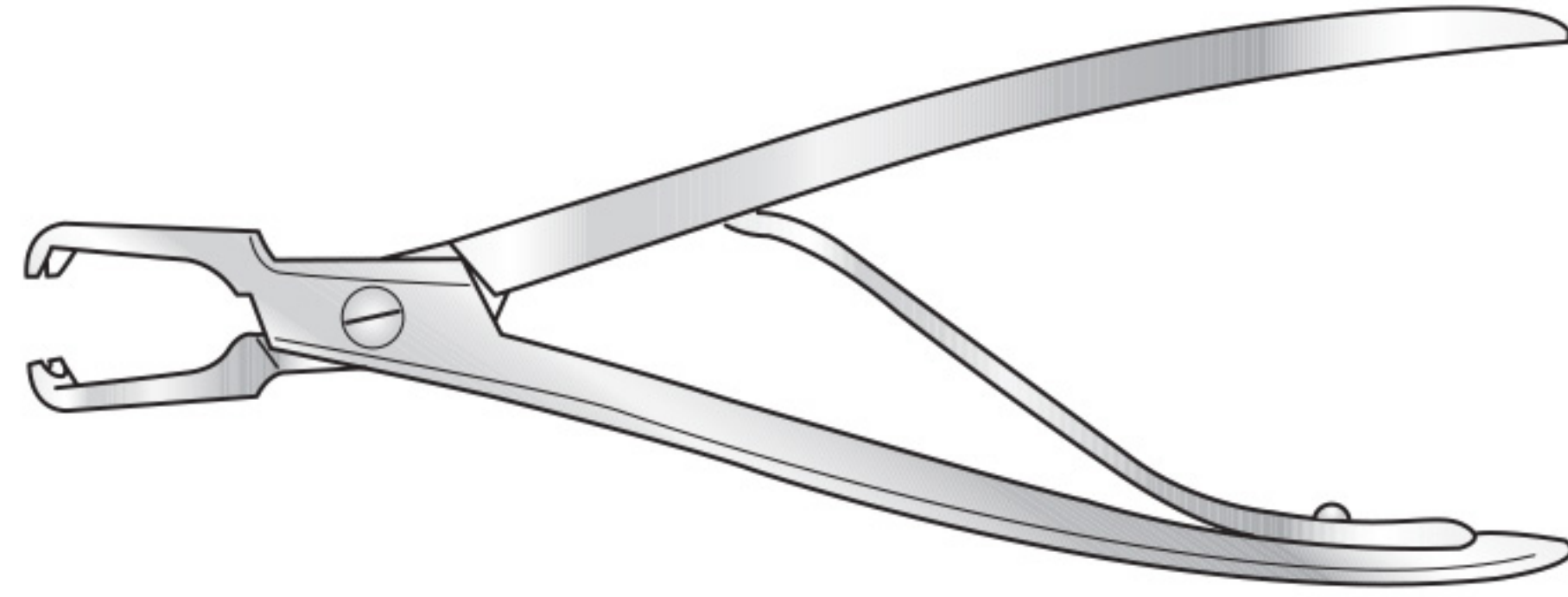

Code	Description
FST-6-230	180mm long

Sequestrum (Necrosis) Forcep

Straight, long fine jaws

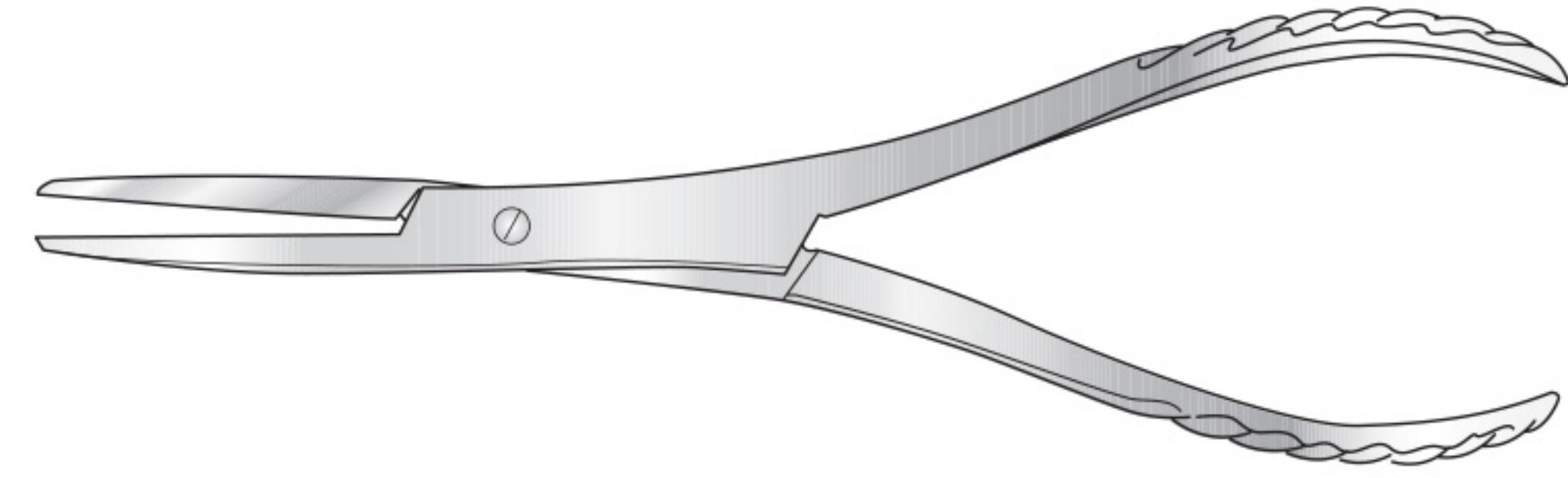

Code	Description
FST-6-231	191mm long
FST-6-232	203mm long

Joint Calcaneal Spreader

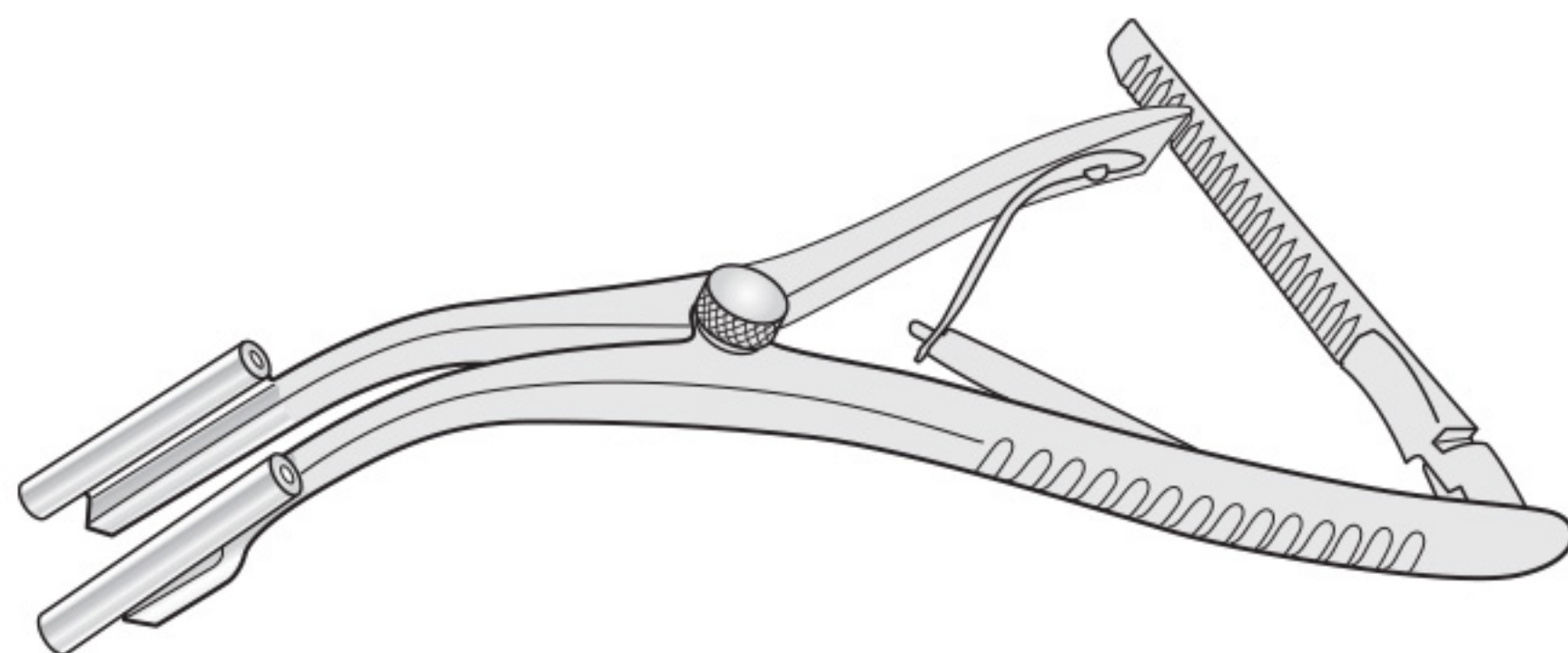

Code	Description
FST-6-233	40mm opening, 1.6mm ø, 170mm long

Calcaneal Spreader

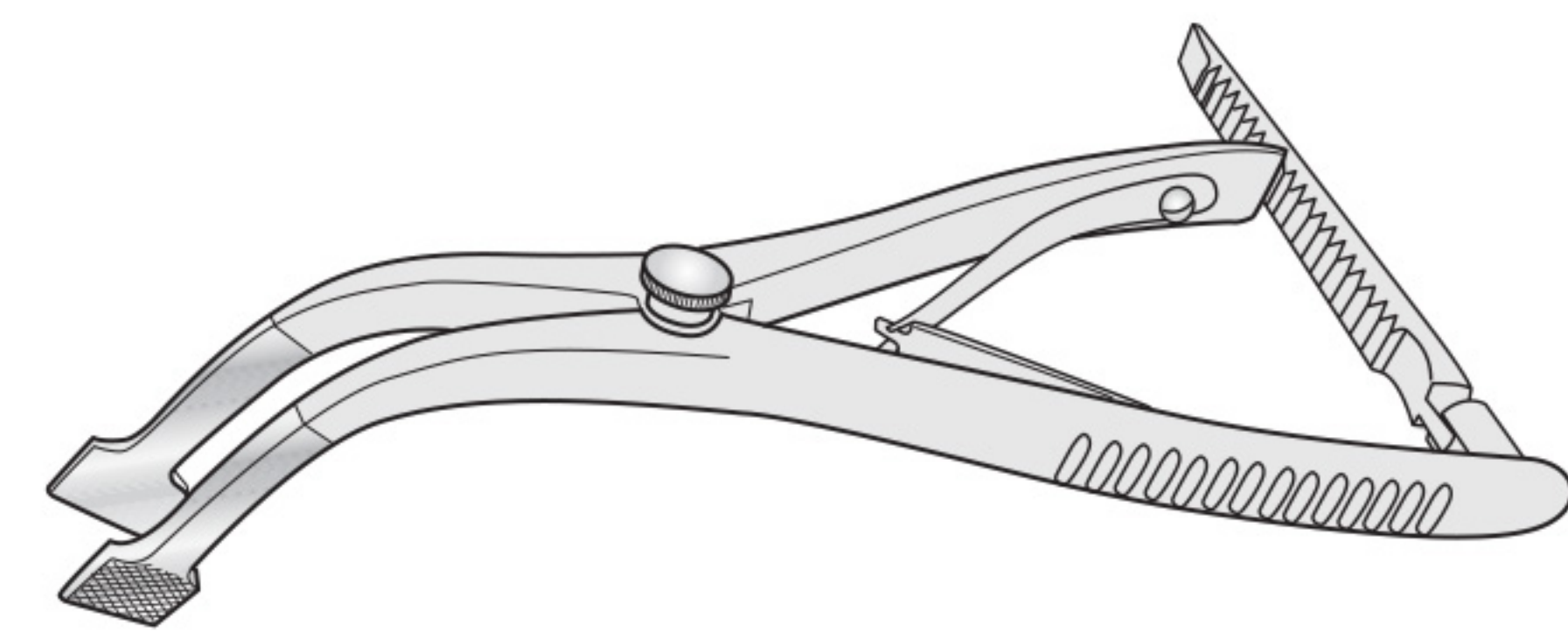

Code	Description
FST-6-234	40mm opening, 15mm wide tip, 70mm long

Inge Type Lamina Spreader

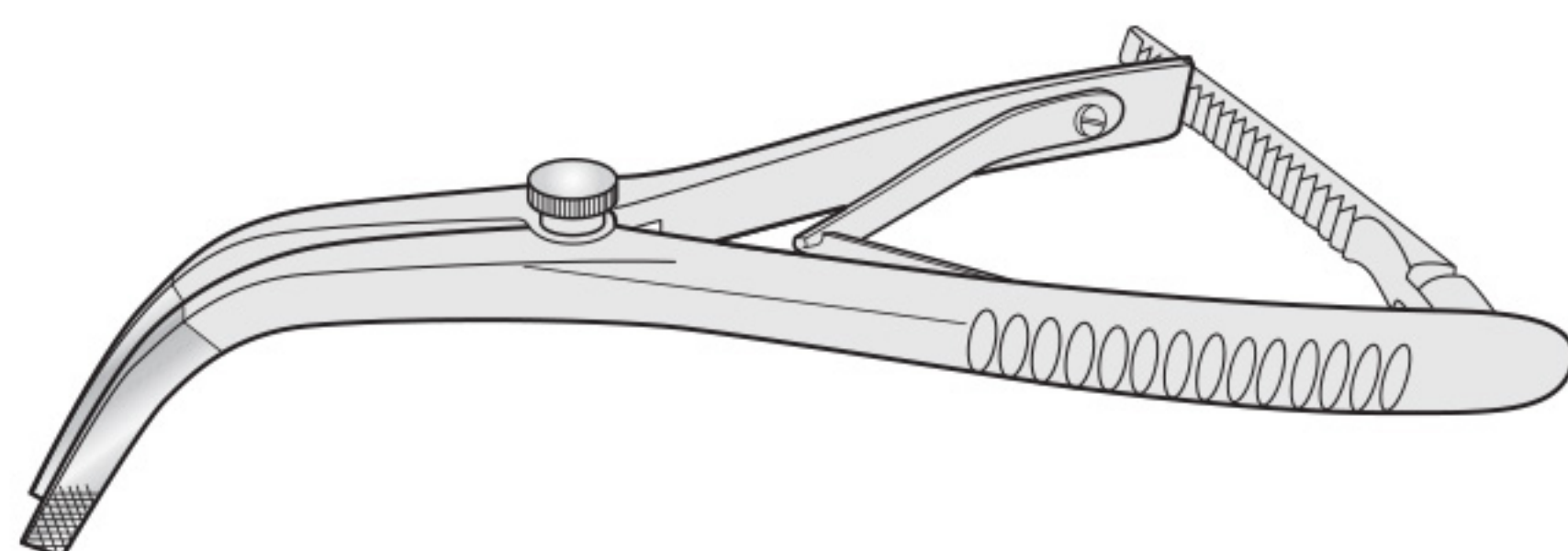

Code	Description
FST-6-235	40mm opening, no teeth, 5mm wide tip, 170mm long

Inge Type Lamina Spreader

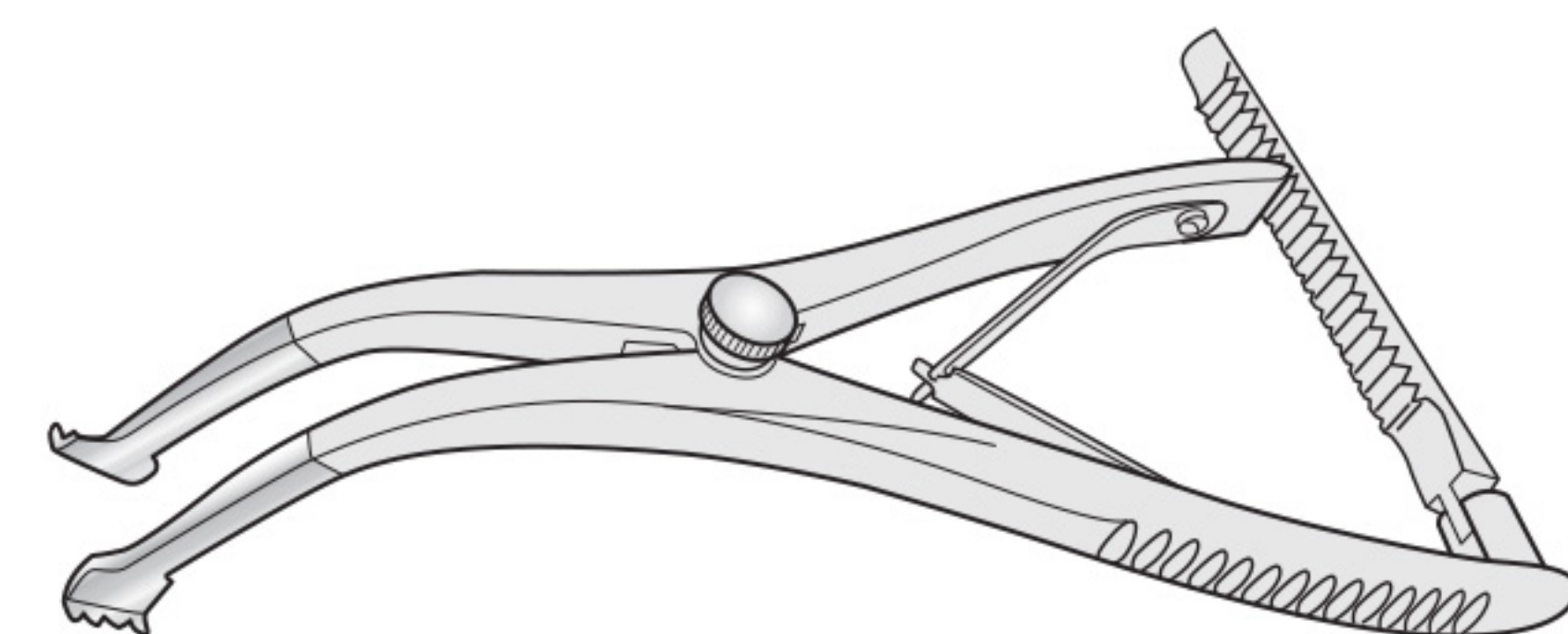

Code	Description
FST-6-236	Baby, 40mm opening, with teeth, 10mm wide tip, 160mm long
FST-6-237	50mm opening, with teeth, 10mm wide tip, 240mm long

Harrison Bone Holding Forceps

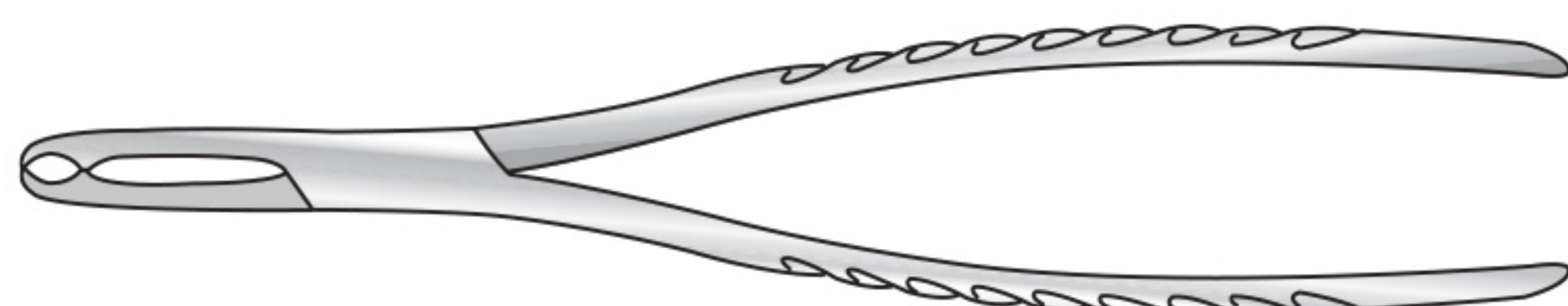

Code	Description
FST-6-238	190mm long

St Thomas Bone Holding Forceps

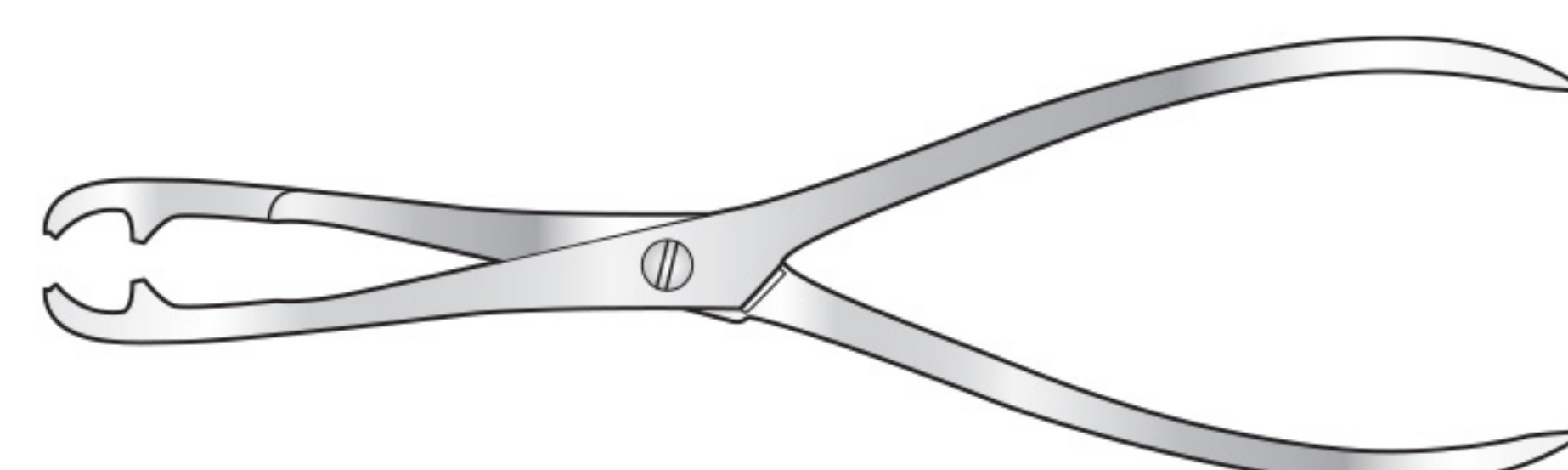

Code	Description
FST-6-239	182mm long

Bone Holding Forceps and Clamps

Burns Bone Holding Forceps

Box joint

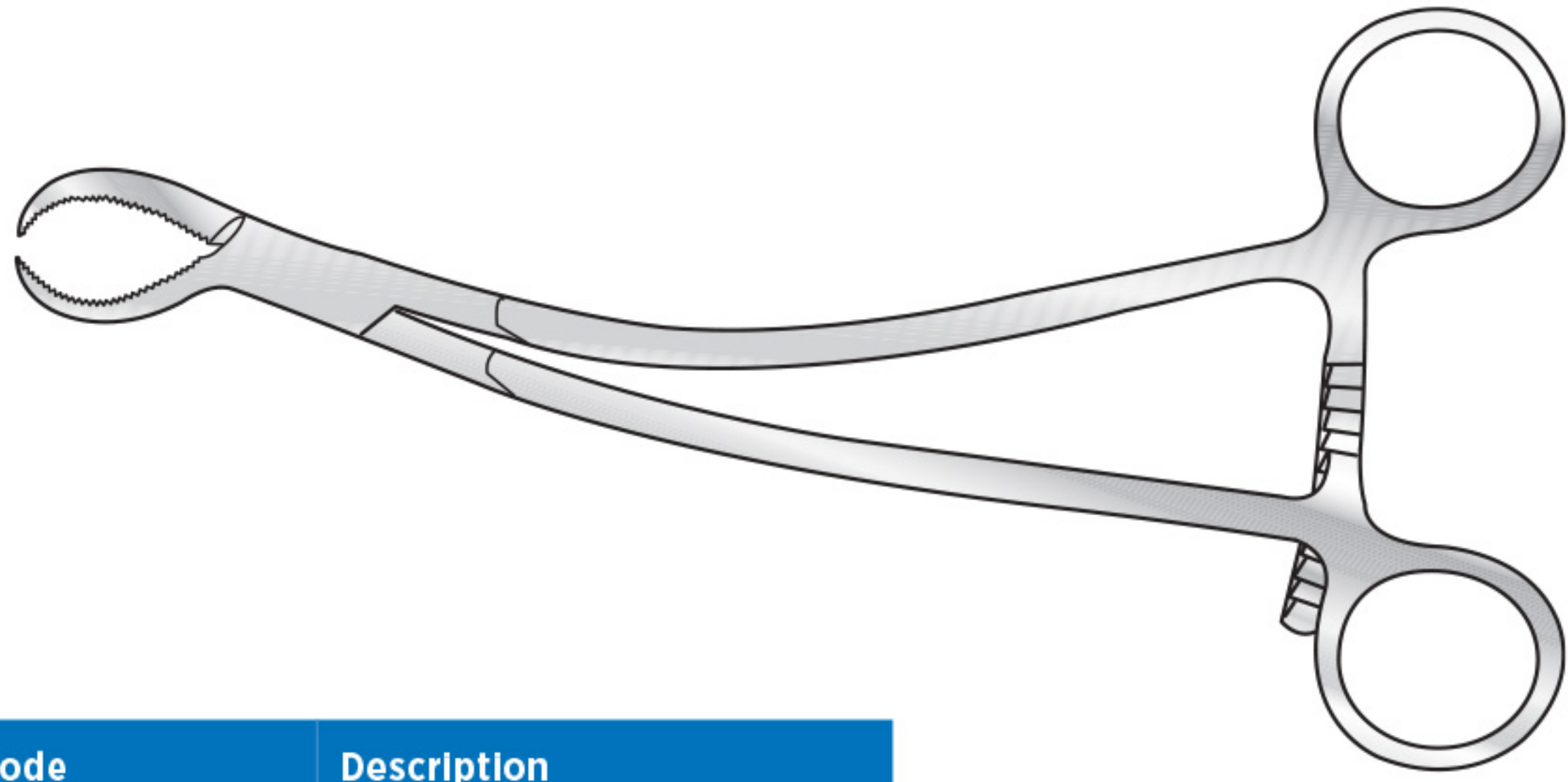

Code	Description
FST-6-250	200mm long

Scarf Type Clamp

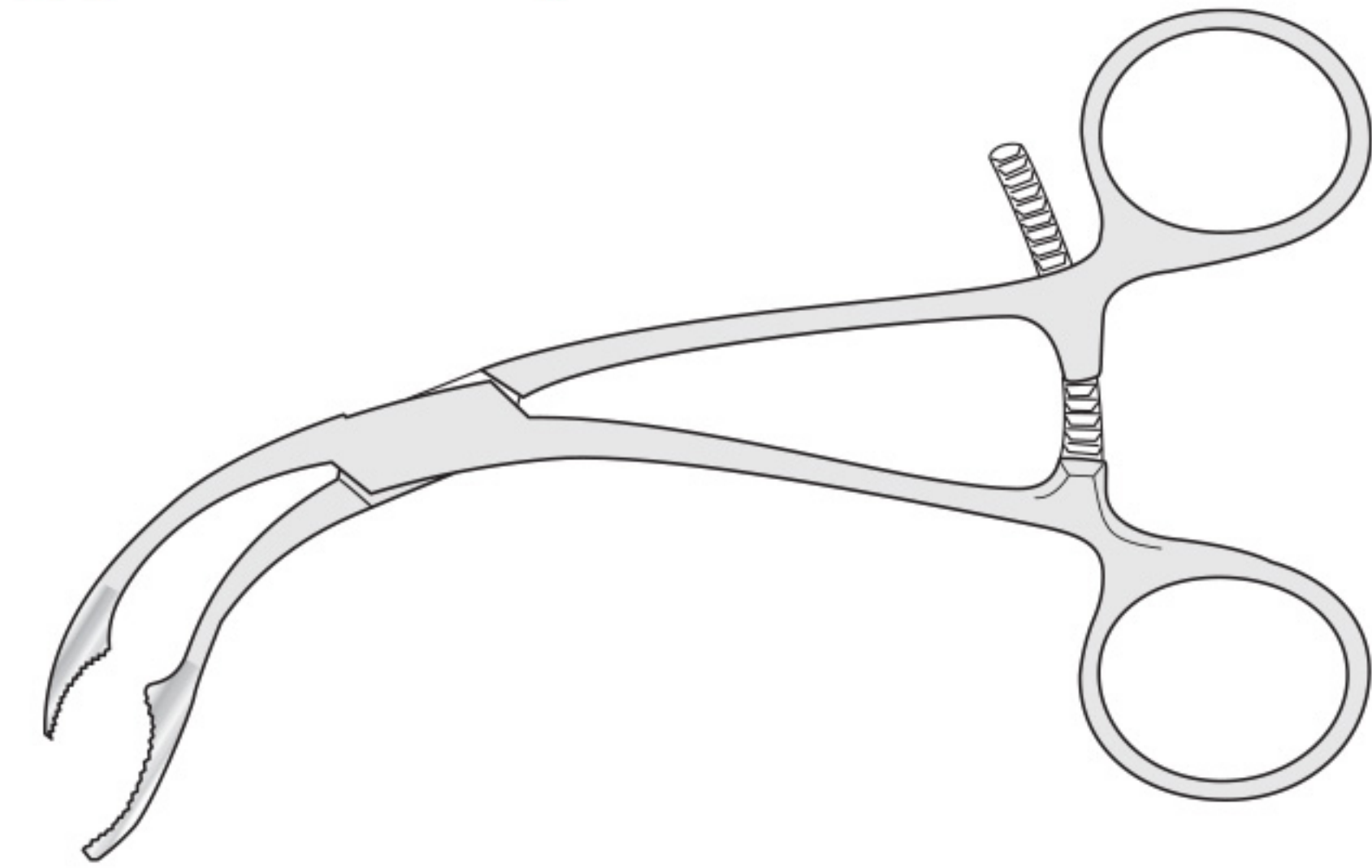

Code	Description
FST-6-251	150mm long

Orthopaedic Grasping Forceps

Box joint

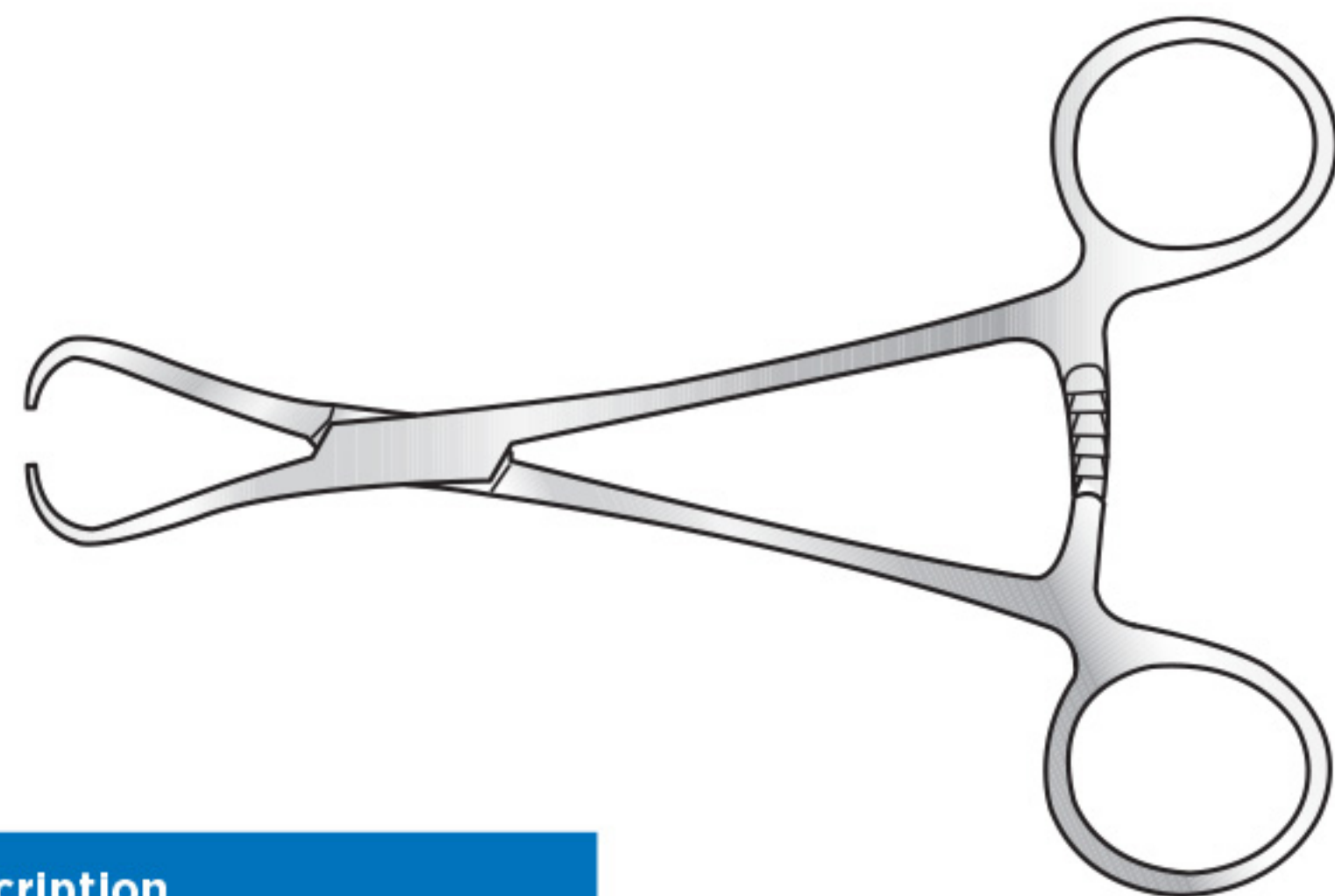

Code	Description
FST-6-252	125mm long
FST-6-253	165mm long

Lowman Bone Holding Clamp

Infant 125mm long
 Child 175mm long
 Adult 205mm long

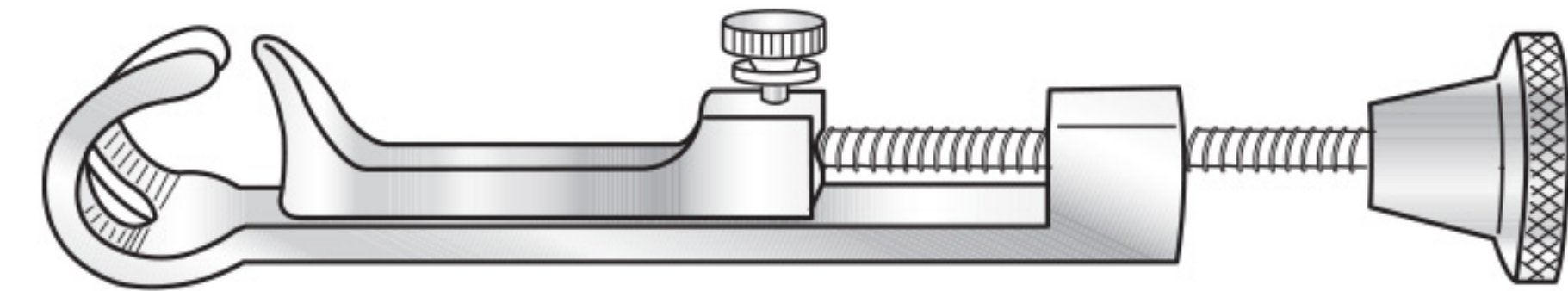

Code
FST-6-254

Reduction Forcep

With adjustable lock

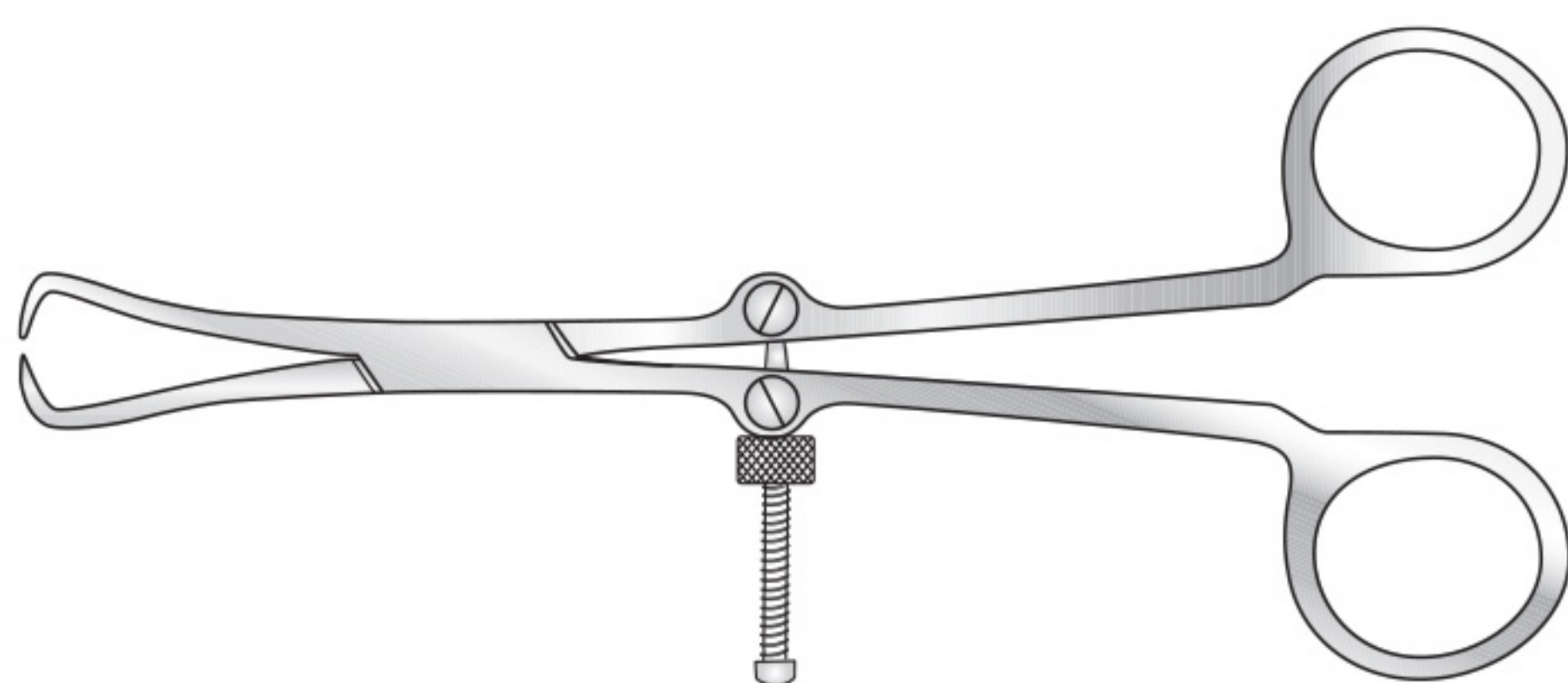

Code	Description
FST-6-255	Small, 135mm long
FST-6-256	Large, 168mm long

Parker Modified Lowman Bone Holding Clamp, Single

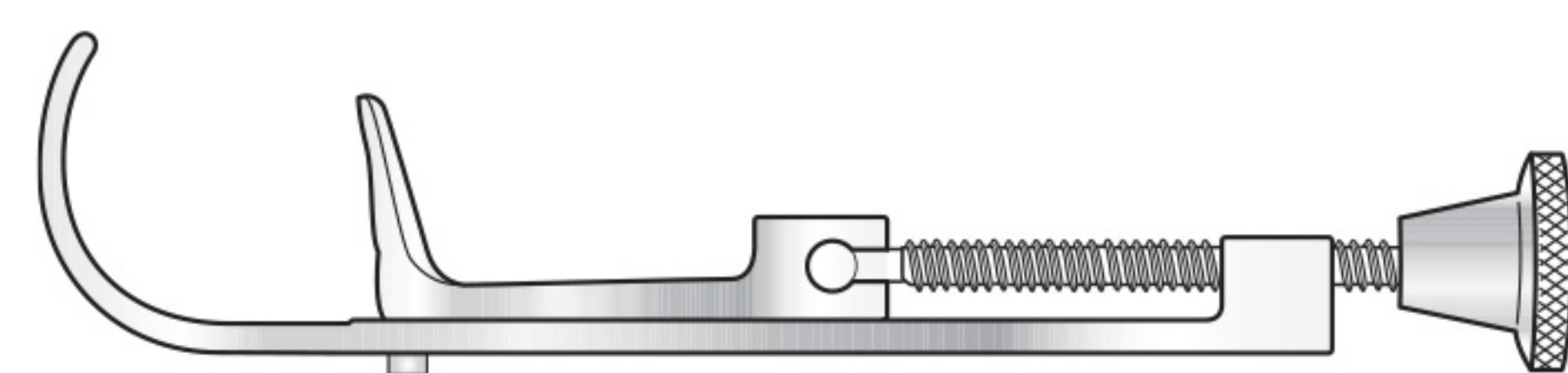

Code	Description
FST-6-257	160mm long

Verbrugge Bone Holding Forceps

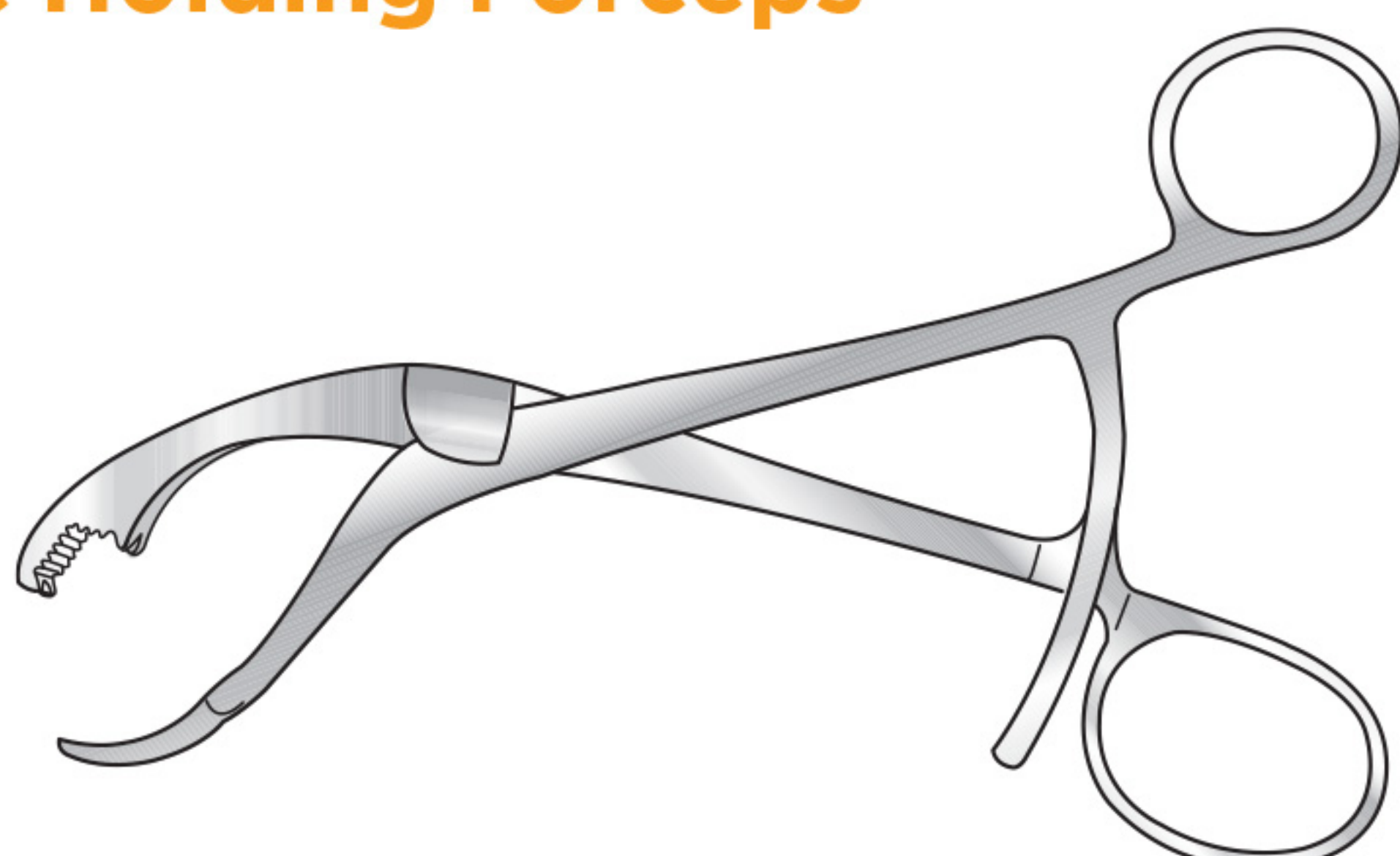

Code	Description
FST-6-258	180mm long

Parker Retractor

For use with Lowman clamp

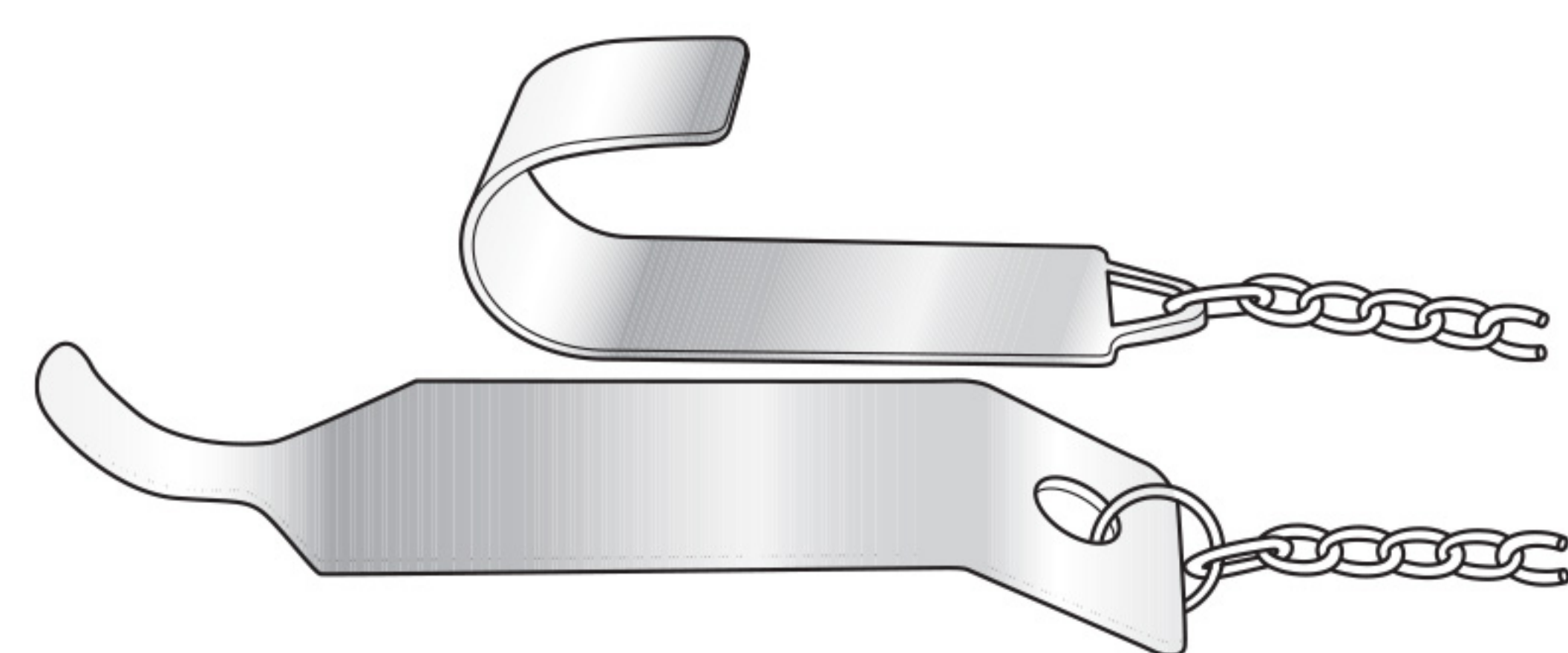

Code	Description
FST-6-259	Chain 850mm long

Haglund Plaster Spreader

Working part curved in right

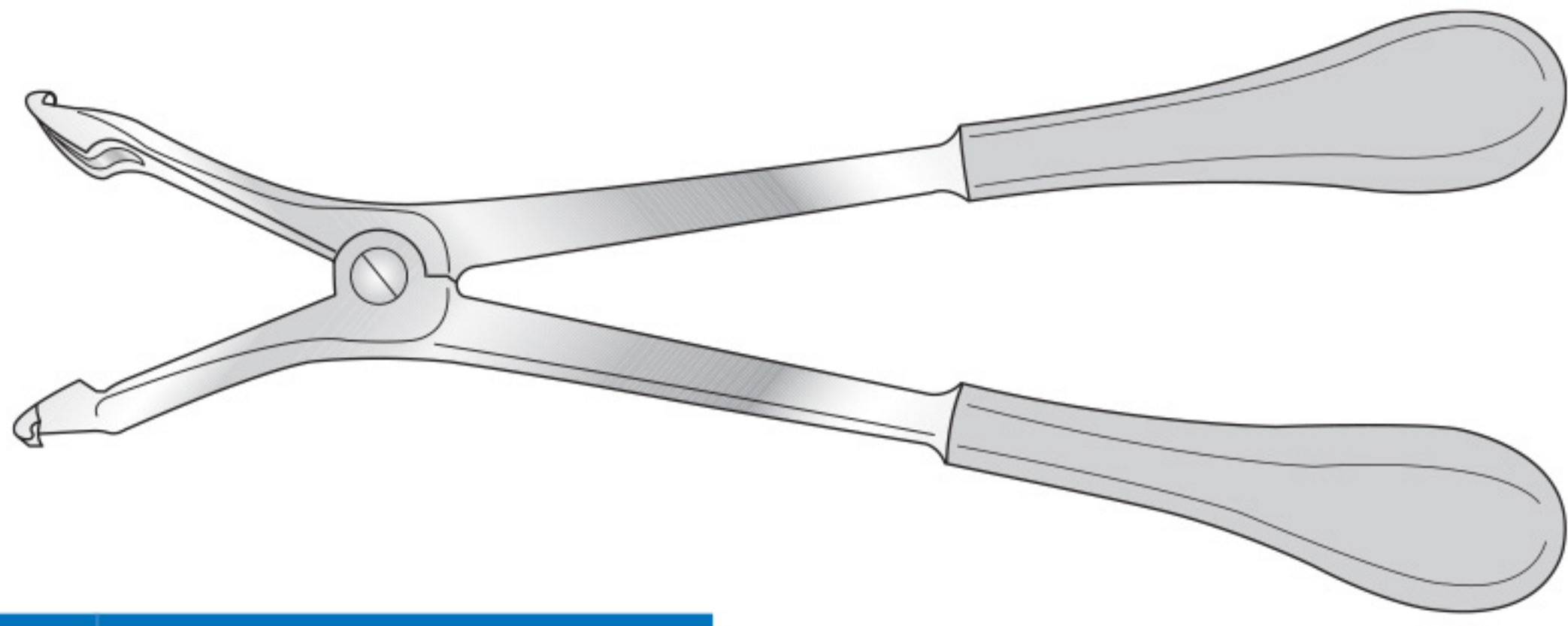

Code	Description
FST-6-270	280mm long

Plaster Cutter

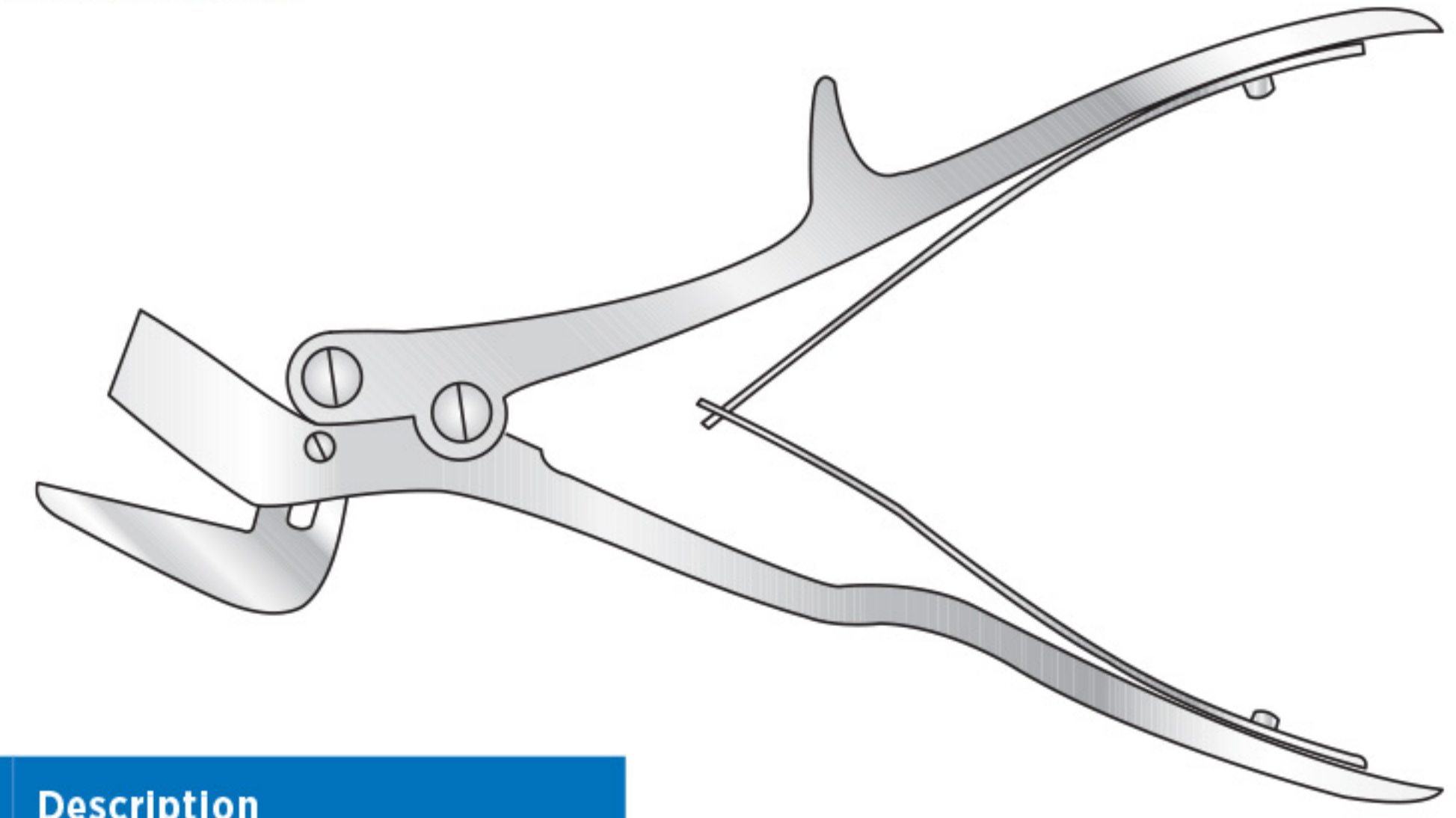

Code	Description
FST-6-271	240mm long

Lawton Plaster Spreader

Working part curved in right

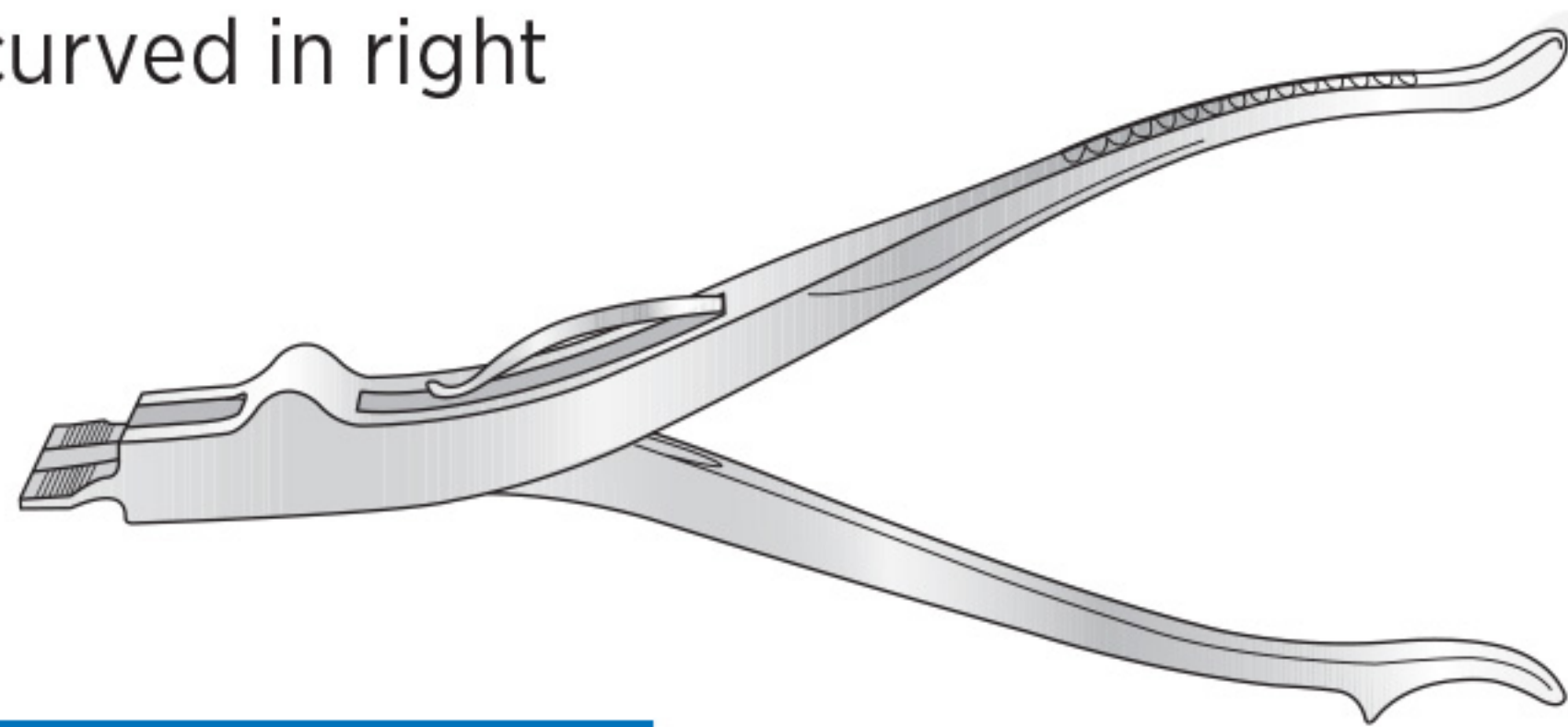

Code	Description
FST-6-272	220mm long

Bohler Plaster Shears

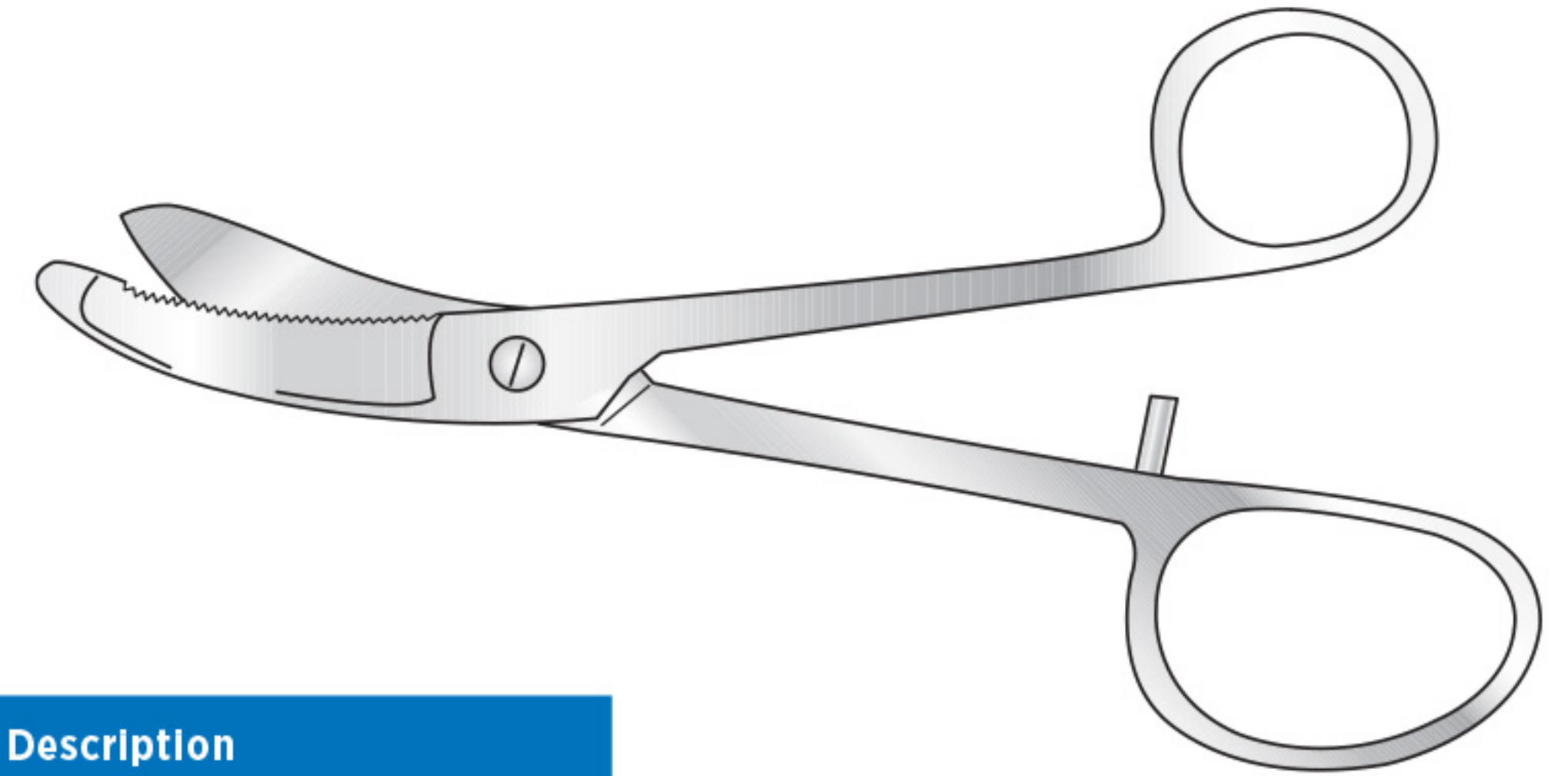

Code	Description
FST-6-273	240mm long

Henning Plaster Spreader

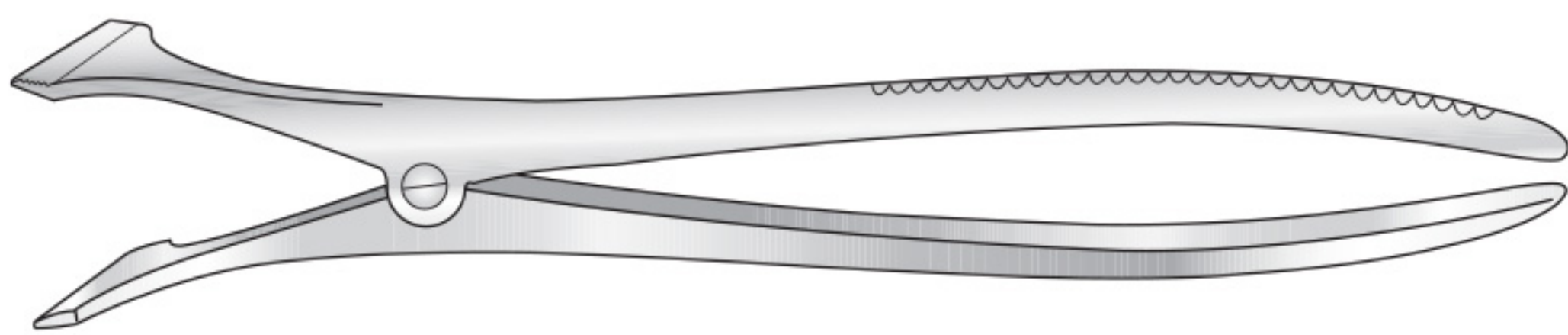

Code	Description
FST-6-274	270mm long

Guys Plaster Shears



Code	Description
FST-6-275	240mm long

Wolf Plaster Spreader



Code	Description
FST-6-276	180mm long
FST-6-277	250mm long

Engel Plaster Saw

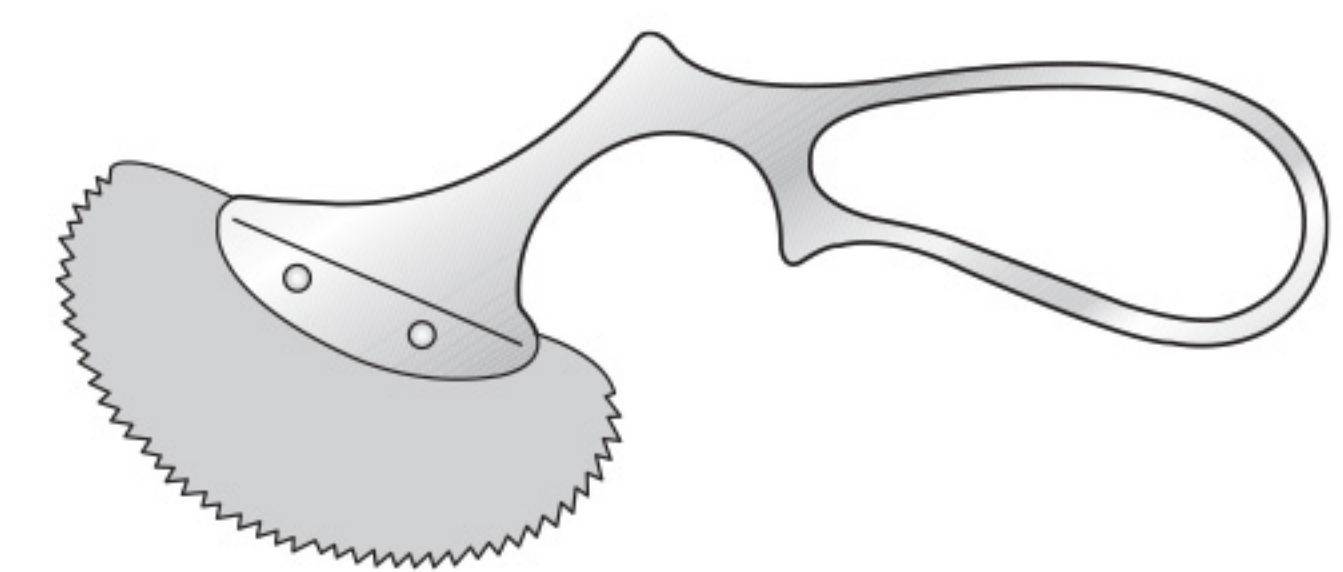

Code	Description
FST-6-278	150mm long

Stille Type Plaster Shears



Code	Description
FST-6-279	380mm long
FST-6-280	330mm long
FST-6-281	460mm long

Eccentric Plaster Shears

Without heavy serrated blade

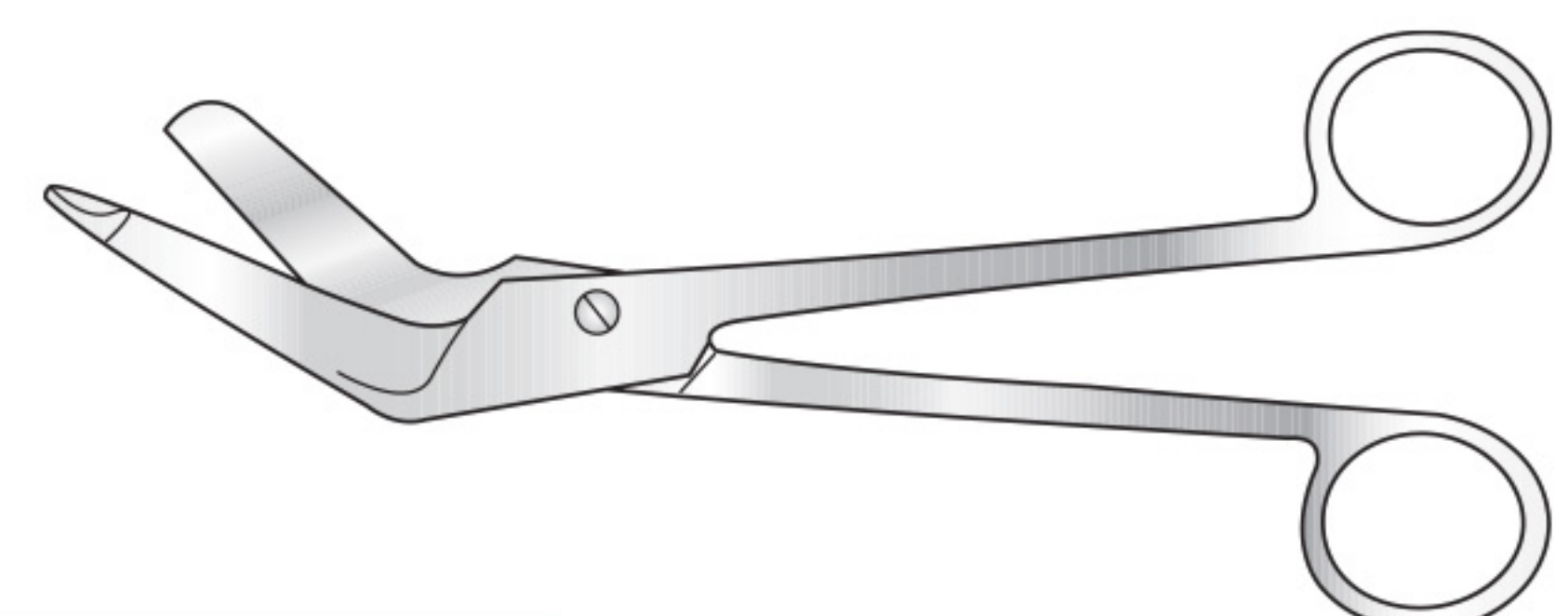

Code	Description
FST-6-282	190mm long

Bone Curettes

Bone Curette

Straight, 180mm long

Code	Description	Code	Description
FST-6-290	Width 2mm	FST-6-294	Width 10mm
FST-6-291	Width 4mm	FST-6-295	Width 12mm
FST-6-292	Width 6mm	FST-6-296	Width 14mm
FST-6-293	Width 8mm	FST-6-297	Width 16mm

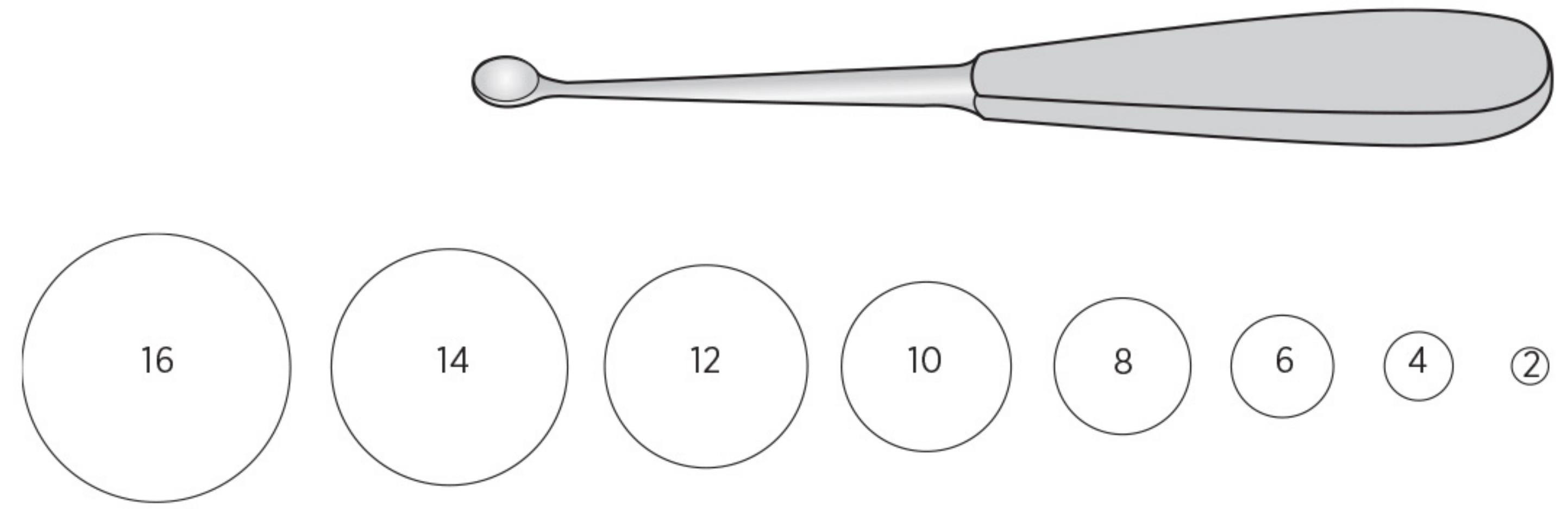

Bone Curette

Straight, 260mm long

Code	Description	Code	Description
FST-6-298	Width 2mm	FST-6-301	Width 8mm
FST-6-299	Width 4mm	FST-6-302	Width 10mm
FST-6-300	Width 6mm	FST-6-303	Width 12mm

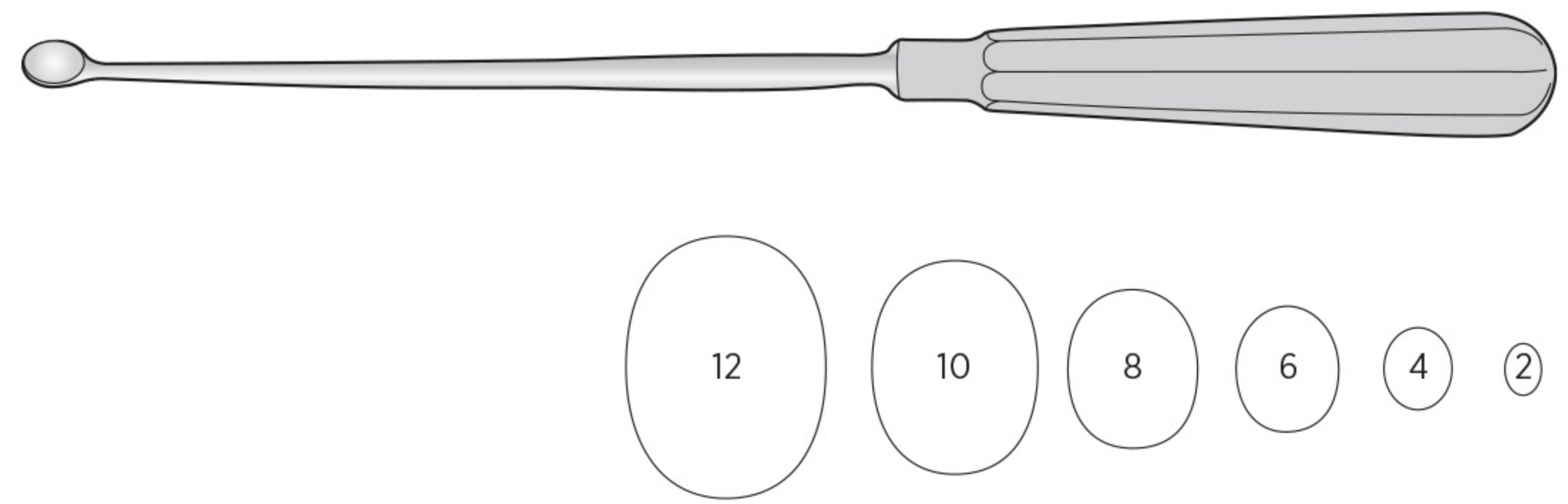

Bone Curette

Straight, 210mm long

Code	Description
FST-6-304	Width 2mm
FST-6-305	Width 4mm
FST-6-306	Width 6mm
FST-6-307	Width 8mm
FST-6-308	Width 10mm
FST-6-309	Width 12mm
FST-6-310	Width 14mm
FST-6-311	Width 16mm
FST-6-312	Width 20mm

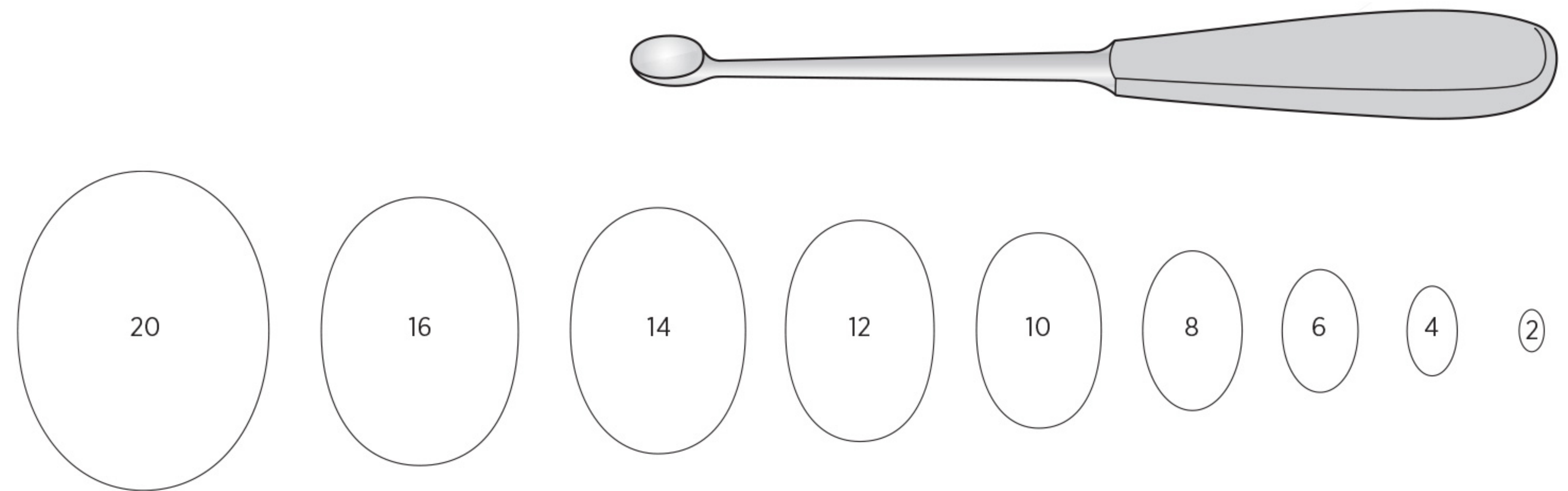

Busche Bone Curette

Angled, 250mm long

Code	Description
FST-6-313	Width 3mm
FST-6-314	Width 4mm
FST-6-315	Width 5mm

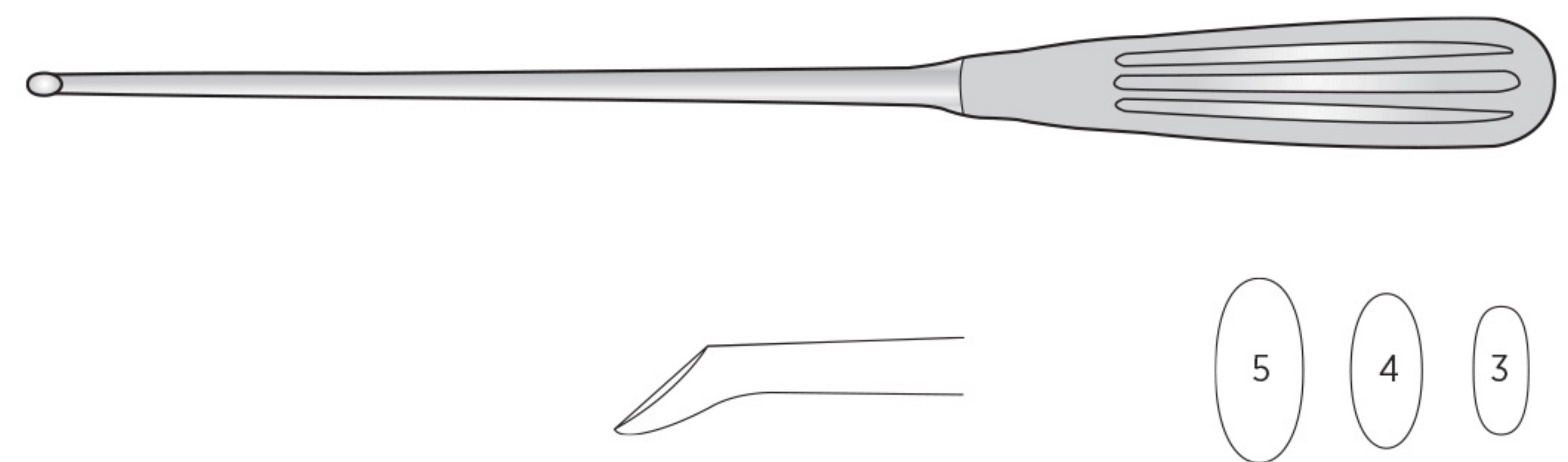

Bruns Bone Curette

225mm long

Straight

Code	Description
FST-6-316	Width 3mm
FST-6-317	Width 4mm
FST-6-318	Width 5mm
FST-6-319	Width 6mm
FST-6-320	Width 7mm
FST-6-321	Width 8mm

Angled

Code	Description
FST-6-322	Width 3mm
FST-6-323	Width 4mm
FST-6-324	Width 5mm
FST-6-325	Width 6mm
FST-6-326	Width 7mm
FST-6-327	Width 8mm

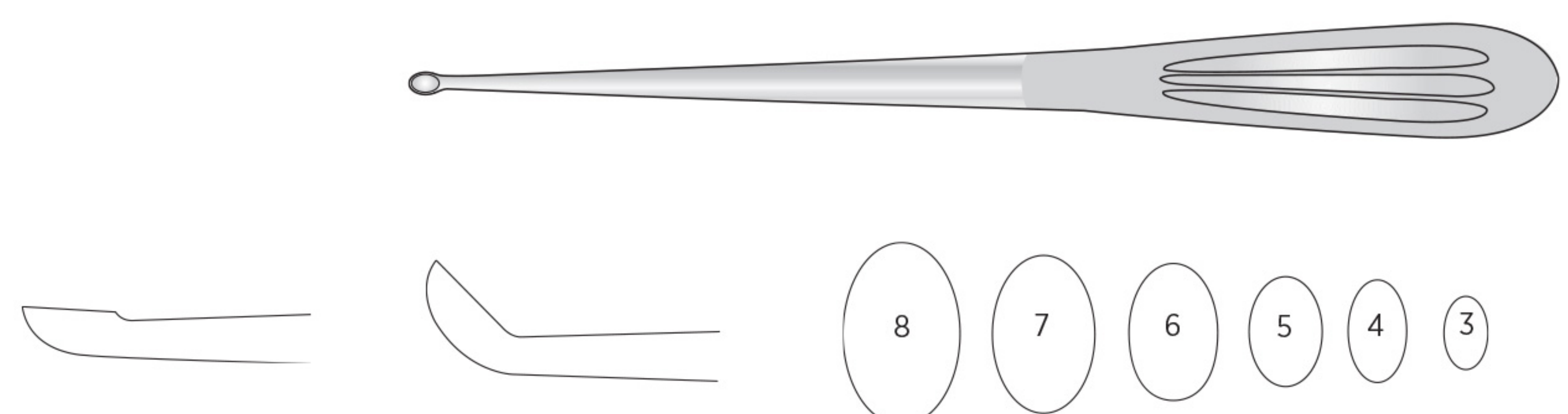

Gourdet Bone Curette

Straight, blunt
280mm long

Code	Description
FST-6-340	Width 6mm
FST-6-341	Width 8mm
FST-6-342	Width 10mm
FST-6-343	Width 12mm
FST-6-344	Width 14mm

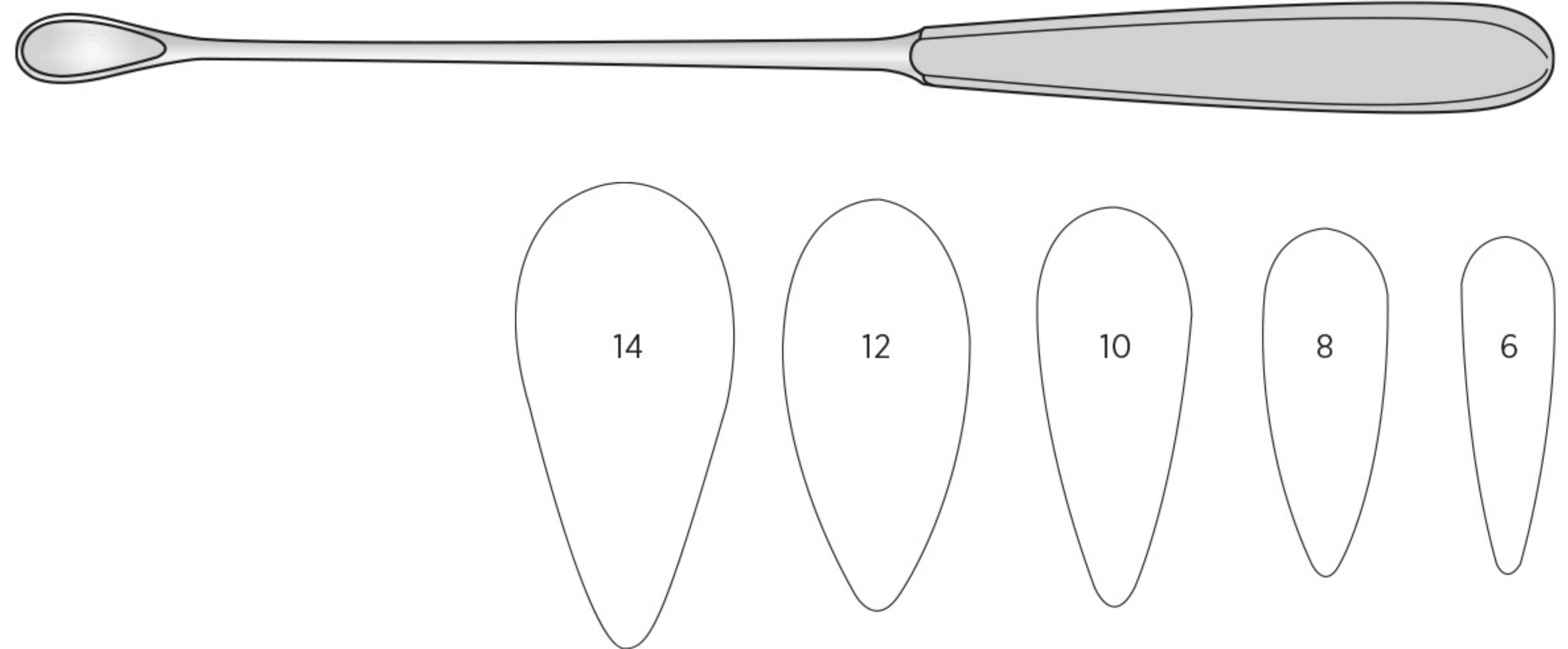

Shroeder Bone Curette

Straight, 310mm long

Code	Description
FST-6-345	Width 6mm
FST-6-346	Width 8mm
FST-6-347	Width 10mm
FST-6-348	Width 12mm
FST-6-349	Width 14mm

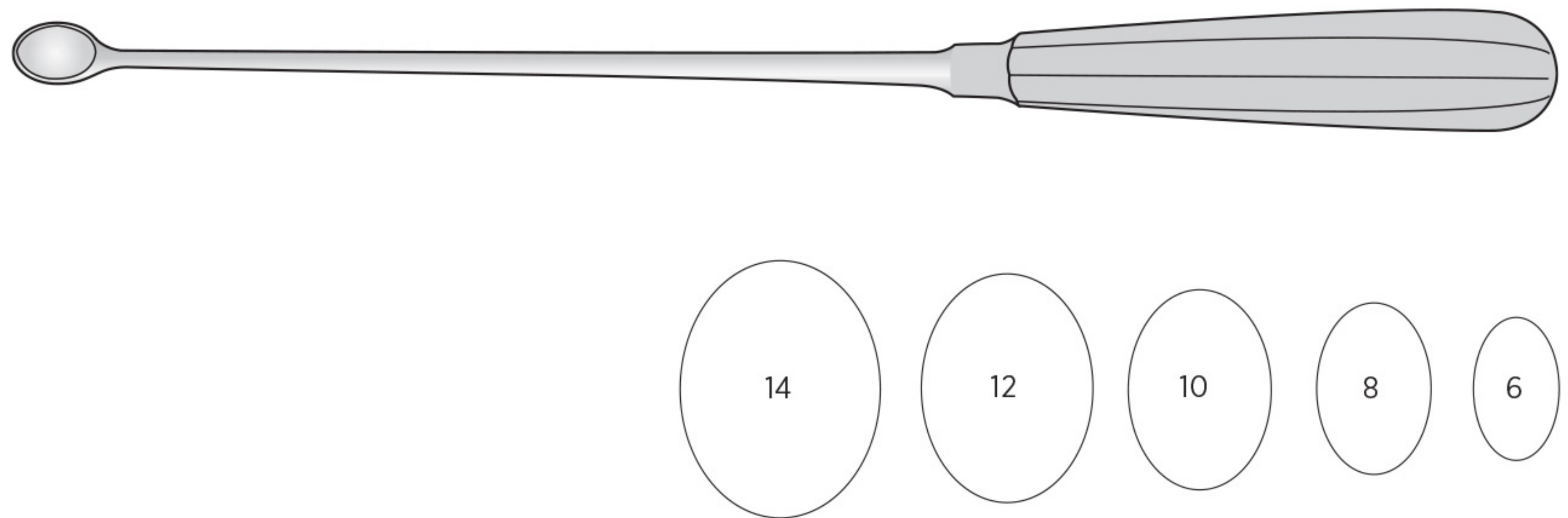

Simon Bone Curette

Straight, 240mm long

Code	Description
FST-6-350	Width 6mm
FST-6-351	Width 8mm
FST-6-352	Width 10mm
FST-6-353	Width 12mm
FST-6-354	Width 14mm

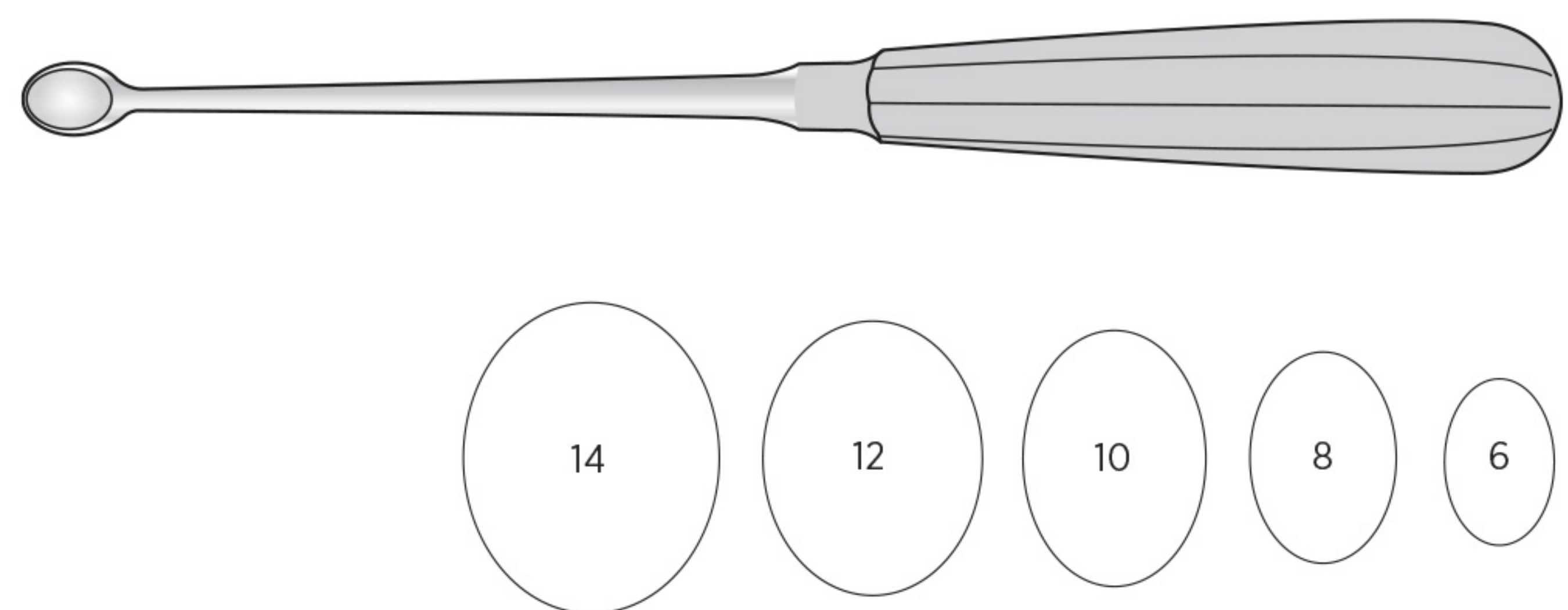

Spinal Curette

Oval, 205mm long

Code	Description	Code	Description
FST-6-355	Width 4mm	FST-6-359	Width 8mm
FST-6-356	Width 5mm	FST-6-360	Width 9mm
FST-6-357	Width 6mm	FST-6-361	Width 10mm
FST-6-358	Width 7mm	FST-6-362	Width 11mm

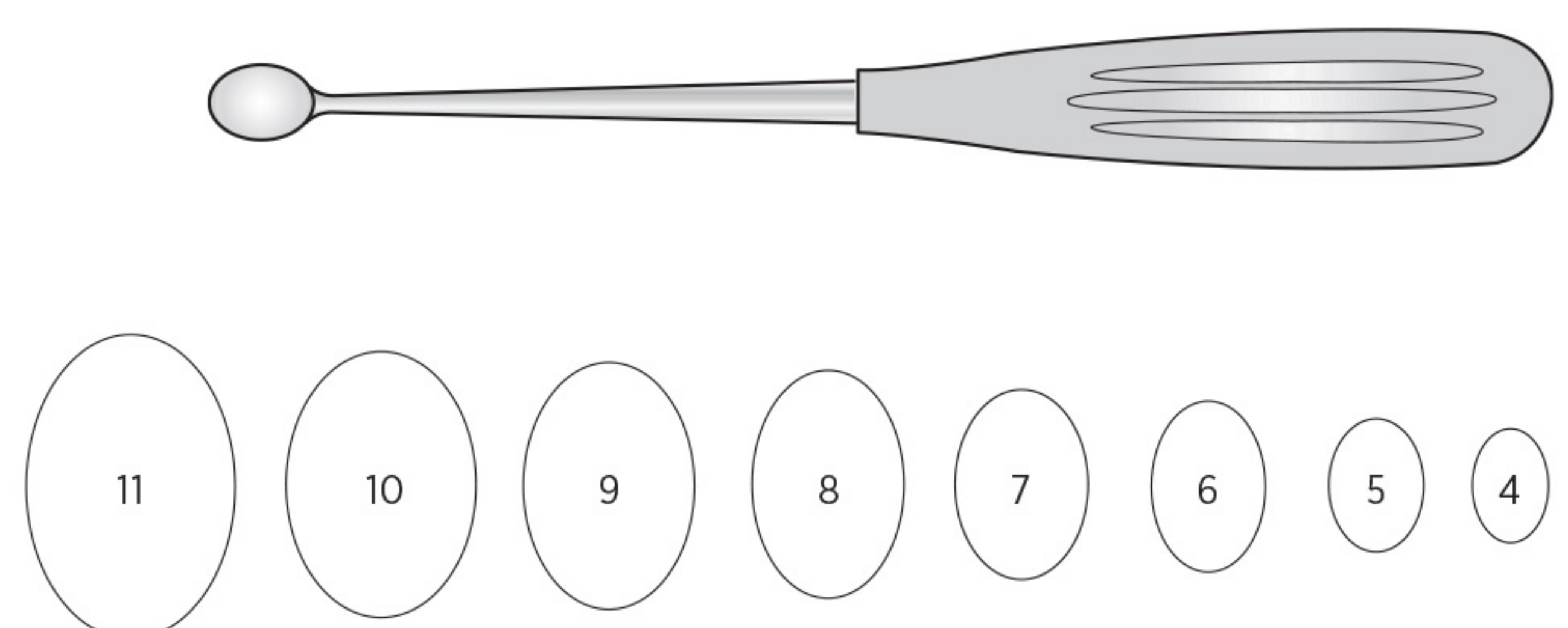

Bone Curettes

Volkman Bone Curette

Straight, 170mm long

Code	Description
FST-6-370	Width 2mm
FST-6-371	Width 3mm
FST-6-372	Width 4mm
FST-6-373	Width 5mm
FST-6-374	Width 6mm

Code	Description
FST-6-375	Width 8mm
FST-6-376	Width 10mm
FST-6-377	Width 12mm
FST-6-378	Width 14mm

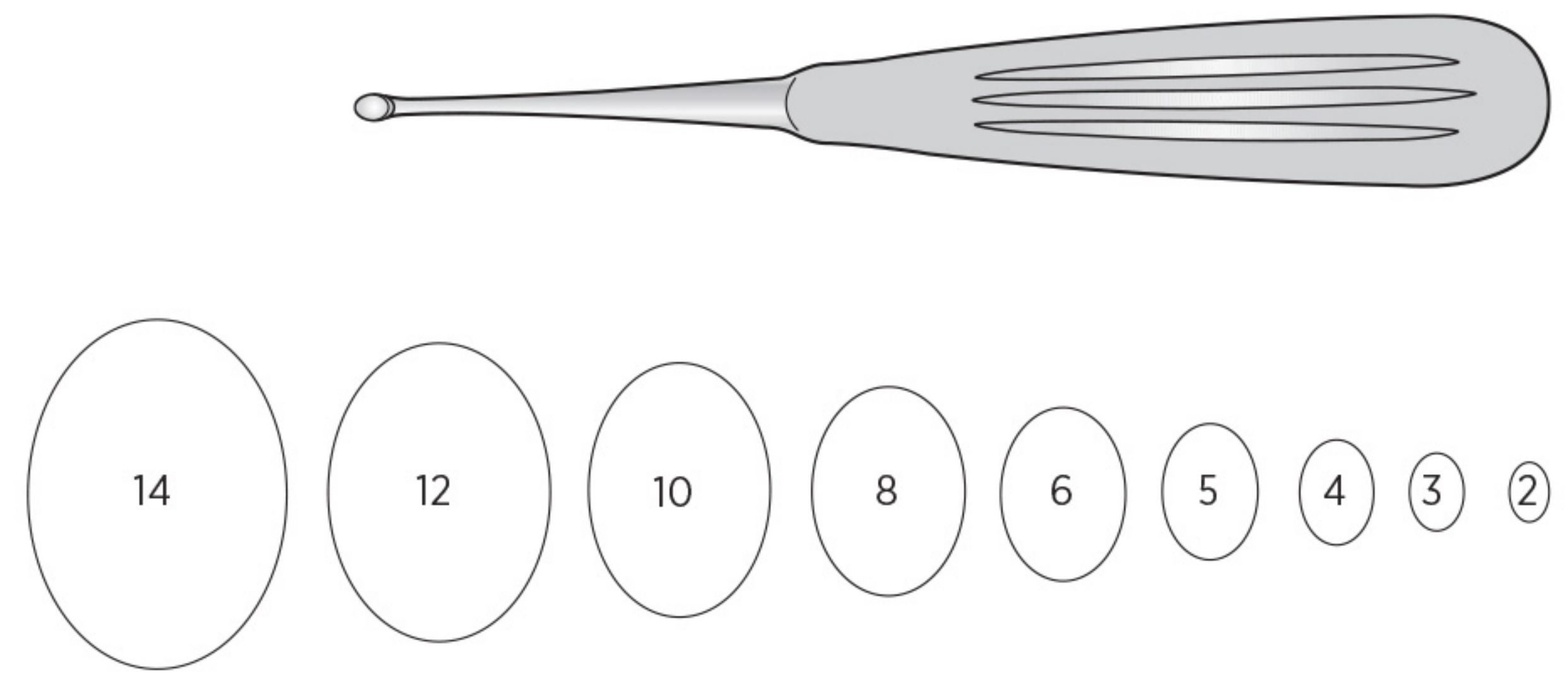

Volkman Bone Curette

Straight, 230mm long

Code	Description
FST-6-379	Bowl width 10mm, bowl length 14.5mm



Wallich Bone Curette

Blunt

Code	Description
FST-6-380	420mm long

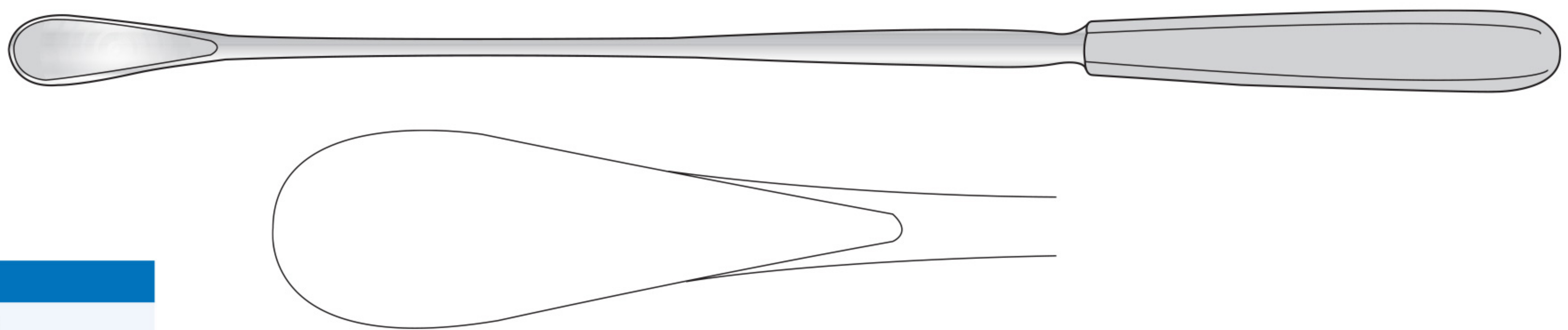

Williger Bone Curette

Straight, 170mm long

Code	Description
FST-6-381	Width 3.5mm
FST-6-382	Width 5.5mm

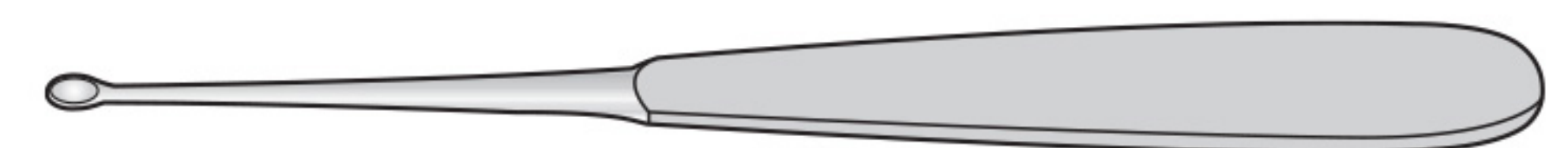

Charnley Bone Curette

With T handle,
380mm long

Code	Description
FST-6-383	Large, 20 x 14mm
FST-6-384	Medium, 17 x 12mm
FST-6-385	Small, 11 x 8mm

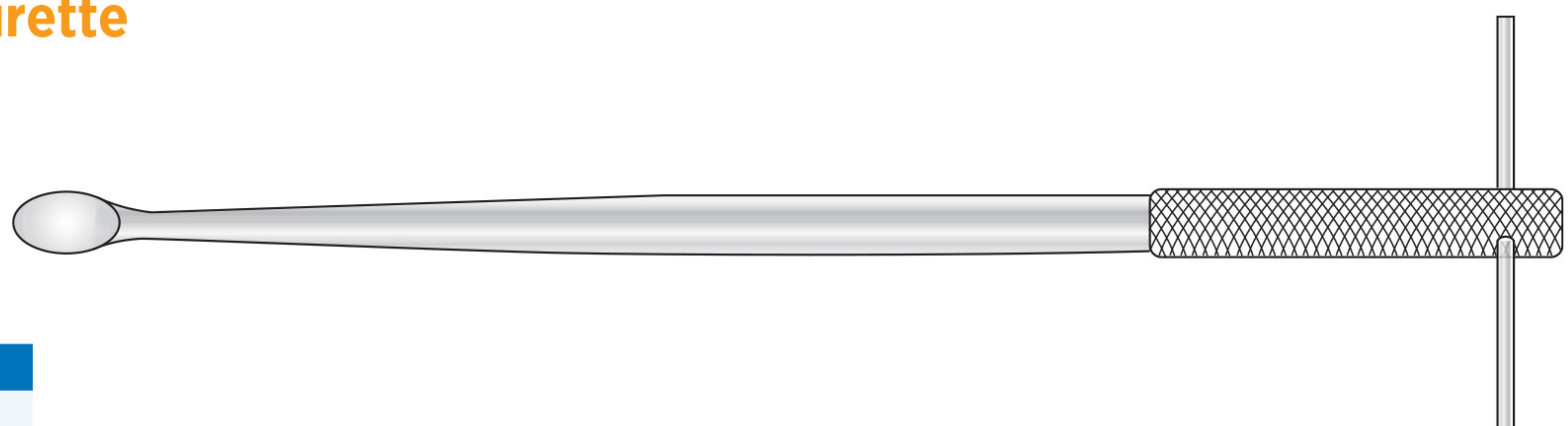

Sybert Bone Curette

Blue acetal "Suregrip" handle, 380mm long

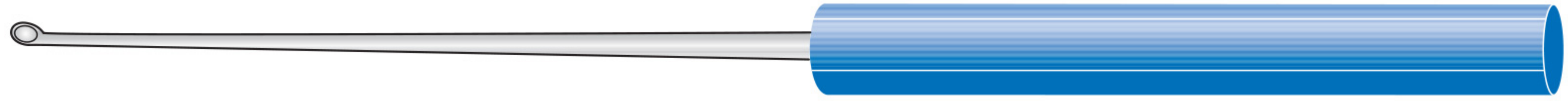

Straight

Code	Description
FST-6-395	Width 3mm
FST-6-396	Width 4mm
FST-6-397	Width 5mm

Angled

Code	Description
FST-6-398	Width 3mm
FST-6-399	Width 4mm
FST-6-400	Width 5mm

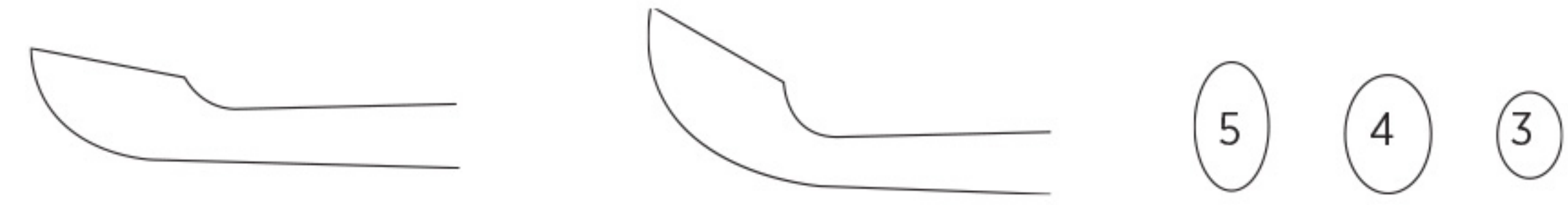

Bone Curette

Blue acetal "Suregrip" handle, 410mm long



Straight

Code	Description
FST-6-401	Width 3mm
FST-6-402	Width 4mm
FST-6-403	Width 5mm

Angled

Code	Description
FST-6-404	Width 3mm
FST-6-405	Width 4mm
FST-6-406	Width 5mm

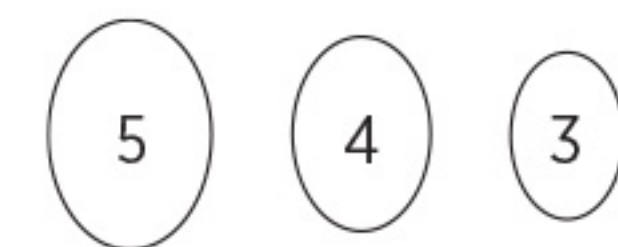

Caspar Bone Curette

Blue acetal "Suregrip" handle, 220mm long

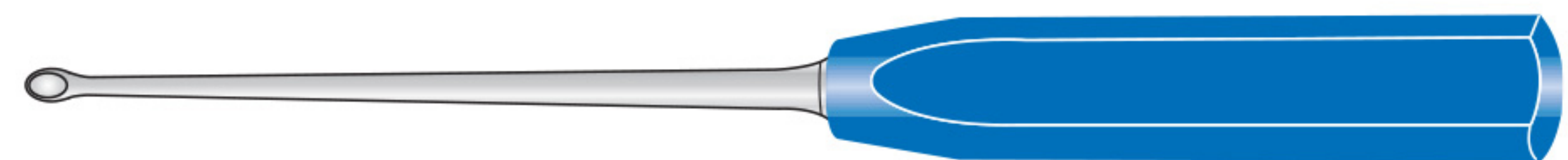

Straight

Code	Description
FST-6-407	Width 3.5mm
FST-6-408	Width 4.5mm
FST-6-409	width 5.5mm

Angled

Code	Description
FST-6-410	Width 3.5mm
FST-6-411	Width 4.5mm
FST-6-412	Width 5.5mm

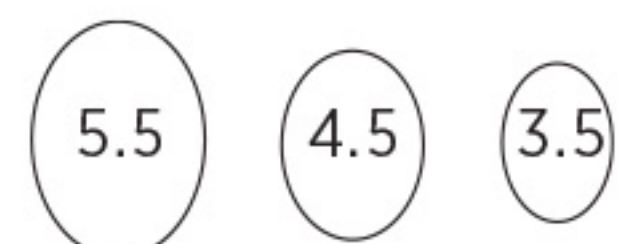

Bone Curette

Blue acetal "Suregrip" handle, 270mm long, straight

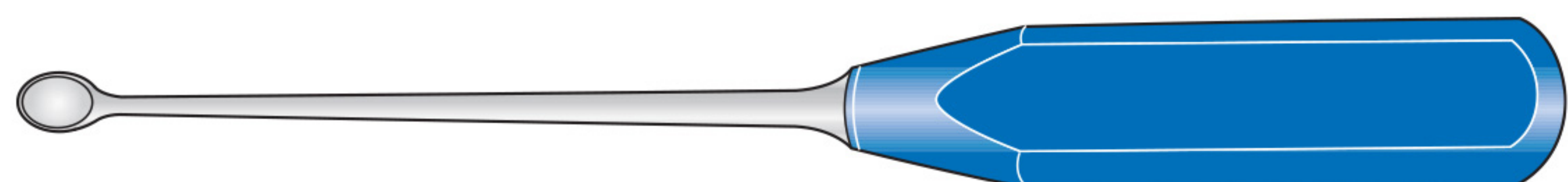

Code	Description
FST-6-413	Width 4mm
FST-6-414	Width 6mm
FST-6-415	Width 8mm
FST-6-416	Width 10mm

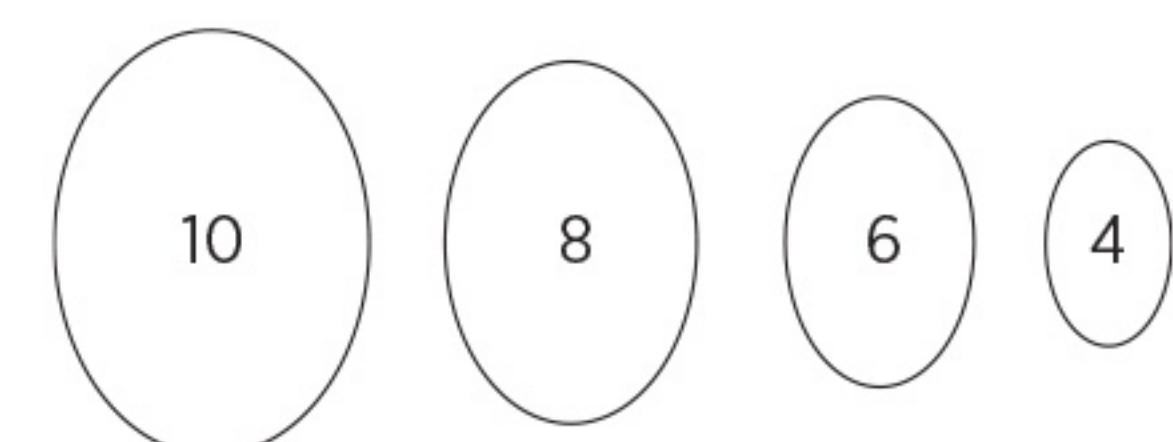

Bone Curettes

Capener Spoon

Blue acetal "Suregrip" handle 285mm long

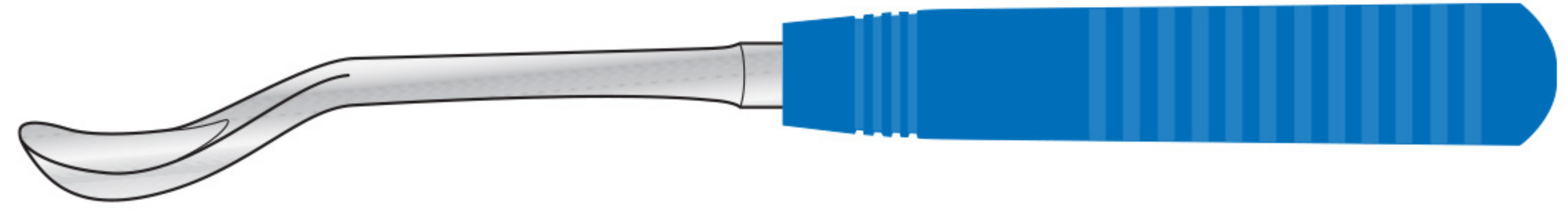

Code	Description
FST-6-425	Width 16mm
FST-6-426	Width 20mm

Capener Lamina Curette

Blue acetal "Suregrip" handle 300mm long

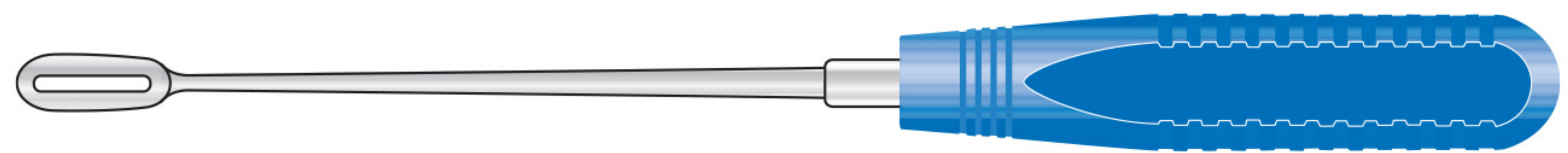

Code	Description
FST-6-427	12 x 32mm
FST-6-428	6 x 18mm

Stanley Boyd Curette

Double ended

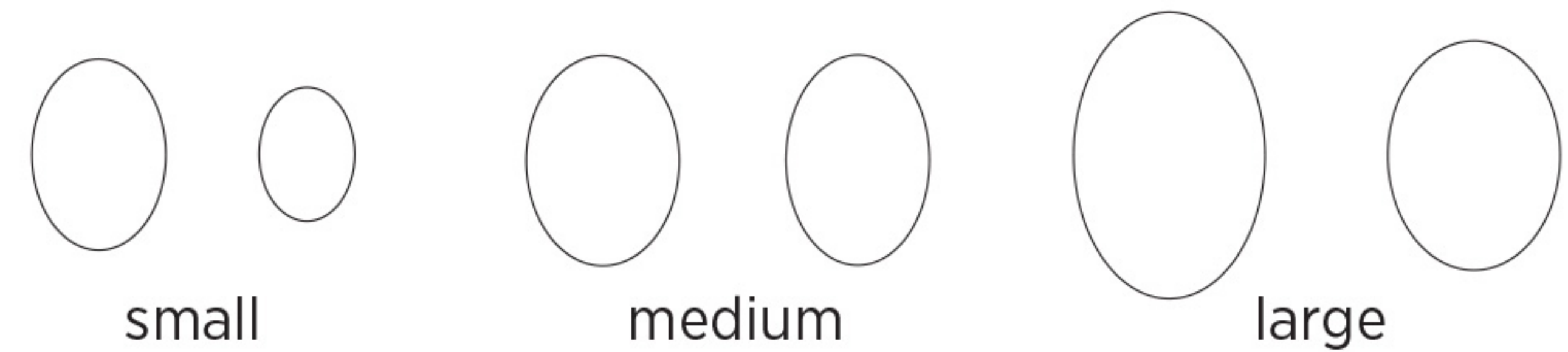

Code	Description
FST-6-429	Small - 50mm long
FST-6-430	Medium - 200mm long
FST-6-431	Large - 250mm long

Volkman Bone Scoop

Double-ended, straight

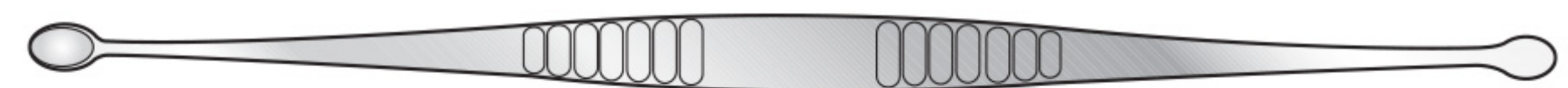

Code	Description
FST-6-432	175mm long
FST-6-433	220mm long
FST-6-434	220mm long

Martini Bone Curette

Shown at half size
 double-ended, straight 140mm long



Code	Description
FST-6-435	Small and medium
FST-6-436	Medium and large

Lane Bone Lever

240mm long

6mm

Code	Description
FST-6-445	Slight curve
FST-6-446	Full curve

8mm

Code	Description
FST-6-447	Slight curve
FST-6-448	Full curve



Lane Bone Lever

For small bones

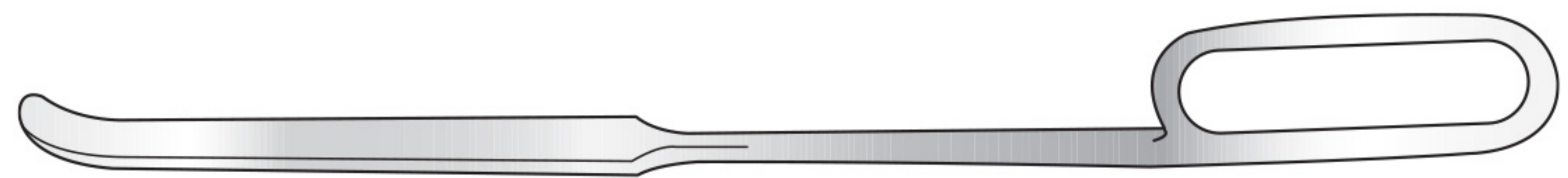

Code	Description
FST-6-449	10mm wide, 265mm long

Lane Bone Lever

For small bones, serrated end

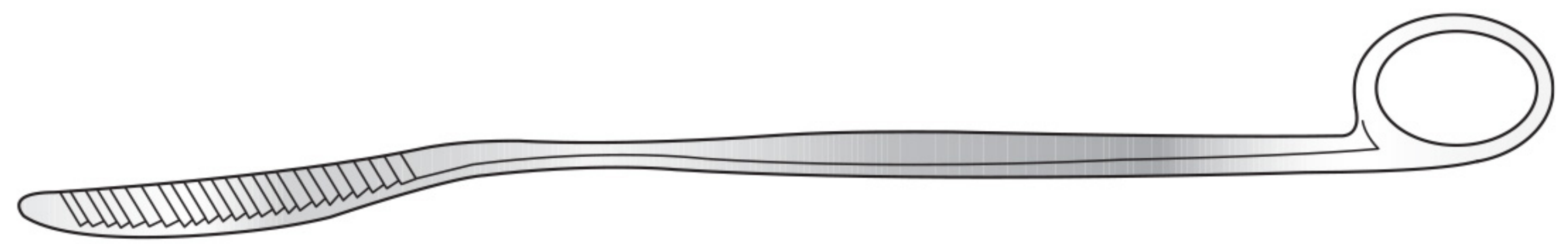

Code	Description
FST-6-450	10mm wide, 260mm long

Trethowan Bone Lever

Ring handle

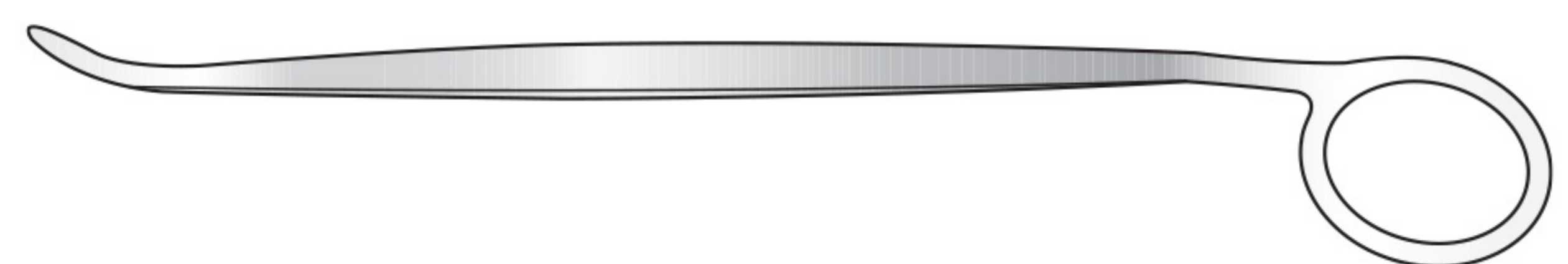

Code	Description
FST-6-451	220mm long

Watson-Jones Bone Lever

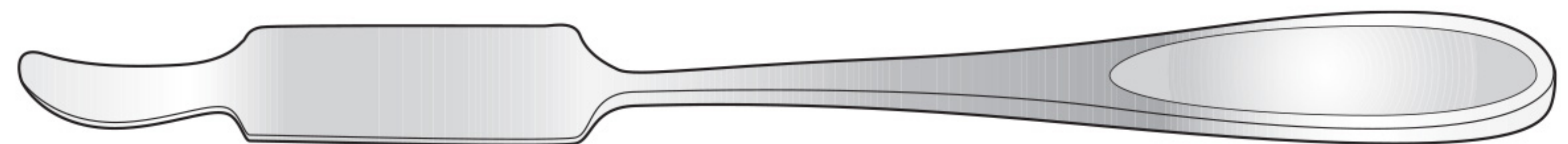

Code	Description
FST-6-452	275mm long

Bankhart Bone Lever



Code	Description
FST-6-453	300mm long

Retractors

Hip Set

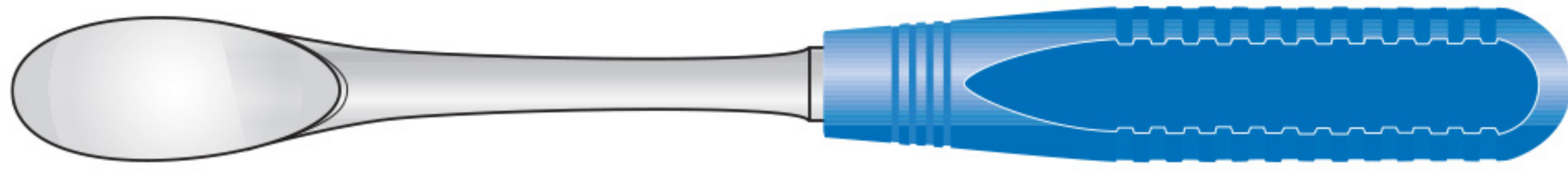

Femoral Dislocation Lever 285mm

Code	Description
FST-6-460	Spoon elevator 25mm with blue acetal suregrip handle - large

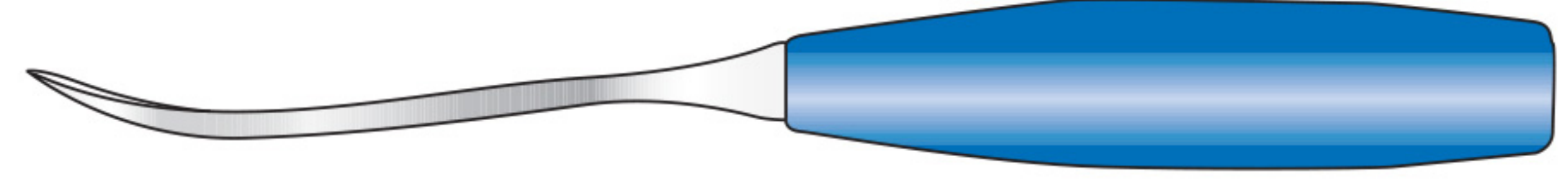

Curved Osteotome 260mm

Code	Description
FST-6-461	With blue acetal suregrip handle - 2

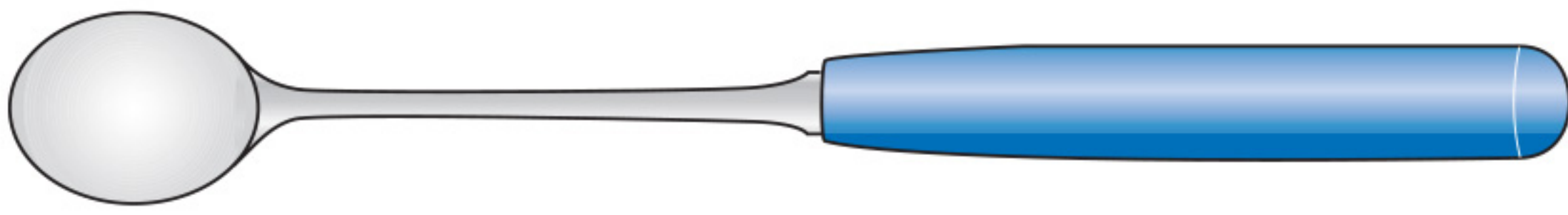

Muller Curette 240mm

Code	Description
FST-6-462	Curette 27mm with blue acetal suregrip handle - large

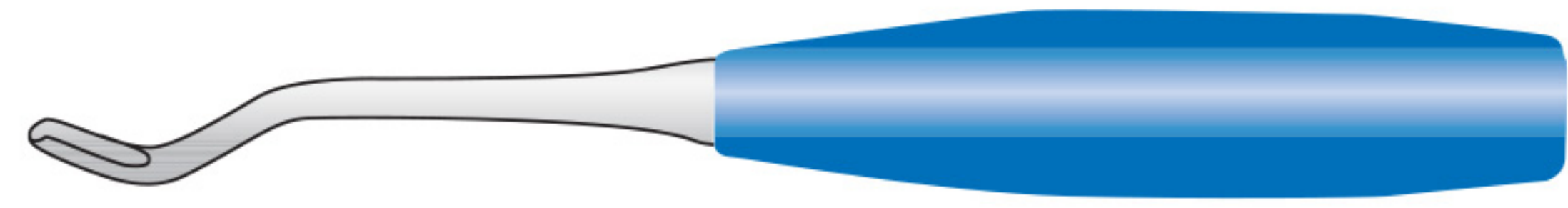

Small Gouge 240mm

Code	Description
FST-6-463	8mm cranked blue acetal suregrip handle



Muller Curette 270mm

Code	Description
FST-6-464	Curette 9mm with blue acetal suregrip handle - small

Charnley Initial Incision Retractor

Code	Description
FST-6-465	Frame only
FST-6-466	Weight only, 75mm x 50mm ø
FST-6-467	Goal post pins and chain

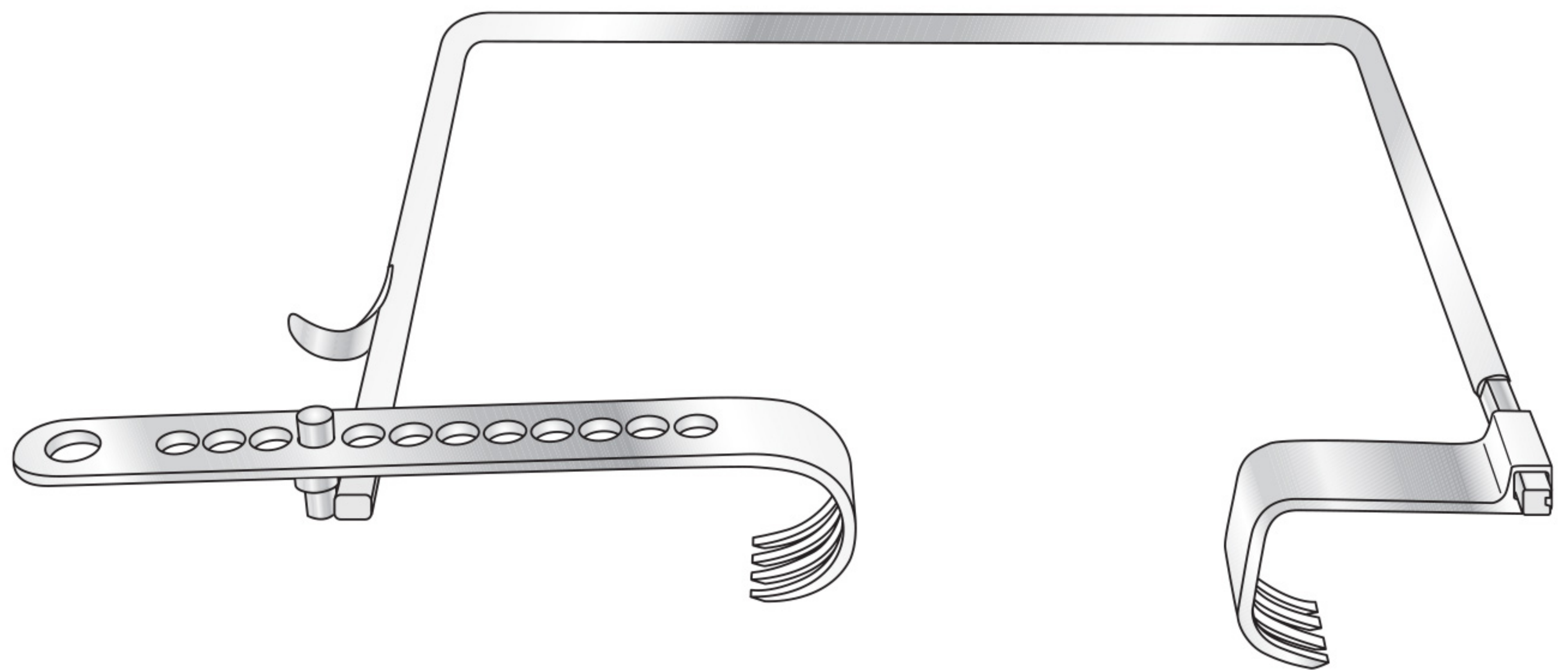

Short blades

Code	Description
FST-6-468	Short blade, 25mm deep
FST-6-469	Short blade, 35mm deep
FST-6-470	Short blade, 50mm deep
FST-6-471	Short blade, 65mm
FST-6-472	Short blade, 75mm deep
FST-6-473	Short blade, 80mm deep
FST-6-474	Short blade, 100mm deep
FST-6-475	Short blade, 125mm
FST-6-476	Short blade, 150mm

Long blades

Code	Description
FST-6-477	Long blade, 35mm deep
FST-6-478	Long blade, 50mm deep
FST-6-479	Long blade, 65mm
FST-6-480	Long blade, 70mm deep
FST-6-481	Long blade, 75mm deep
FST-6-482	Long blade, 100mm deep
FST-6-483	Long blade, 125mm
FST-6-484	Long blade, 150mm
FST-6-485	Long round blade, 50mm deep

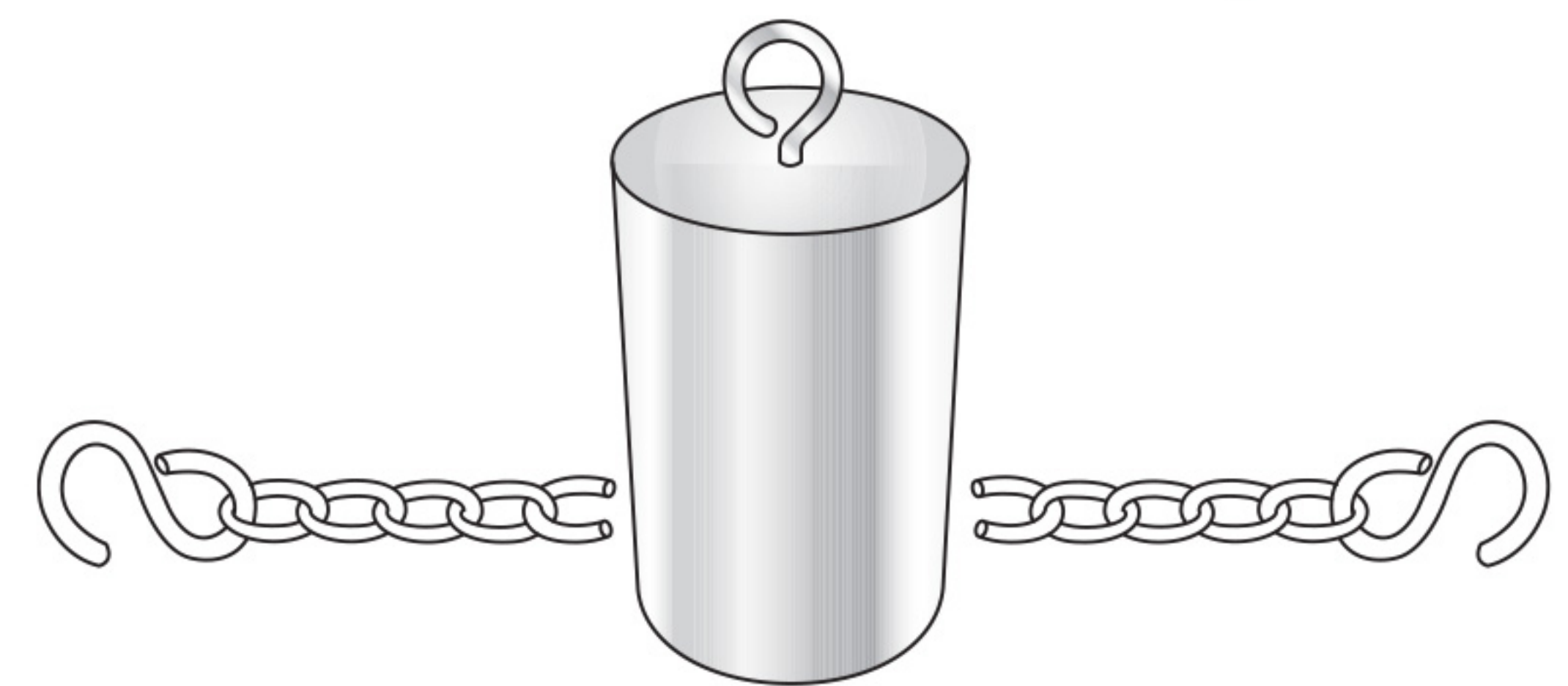

Travers Retractor

Self retaining, internal rack, 210mm long

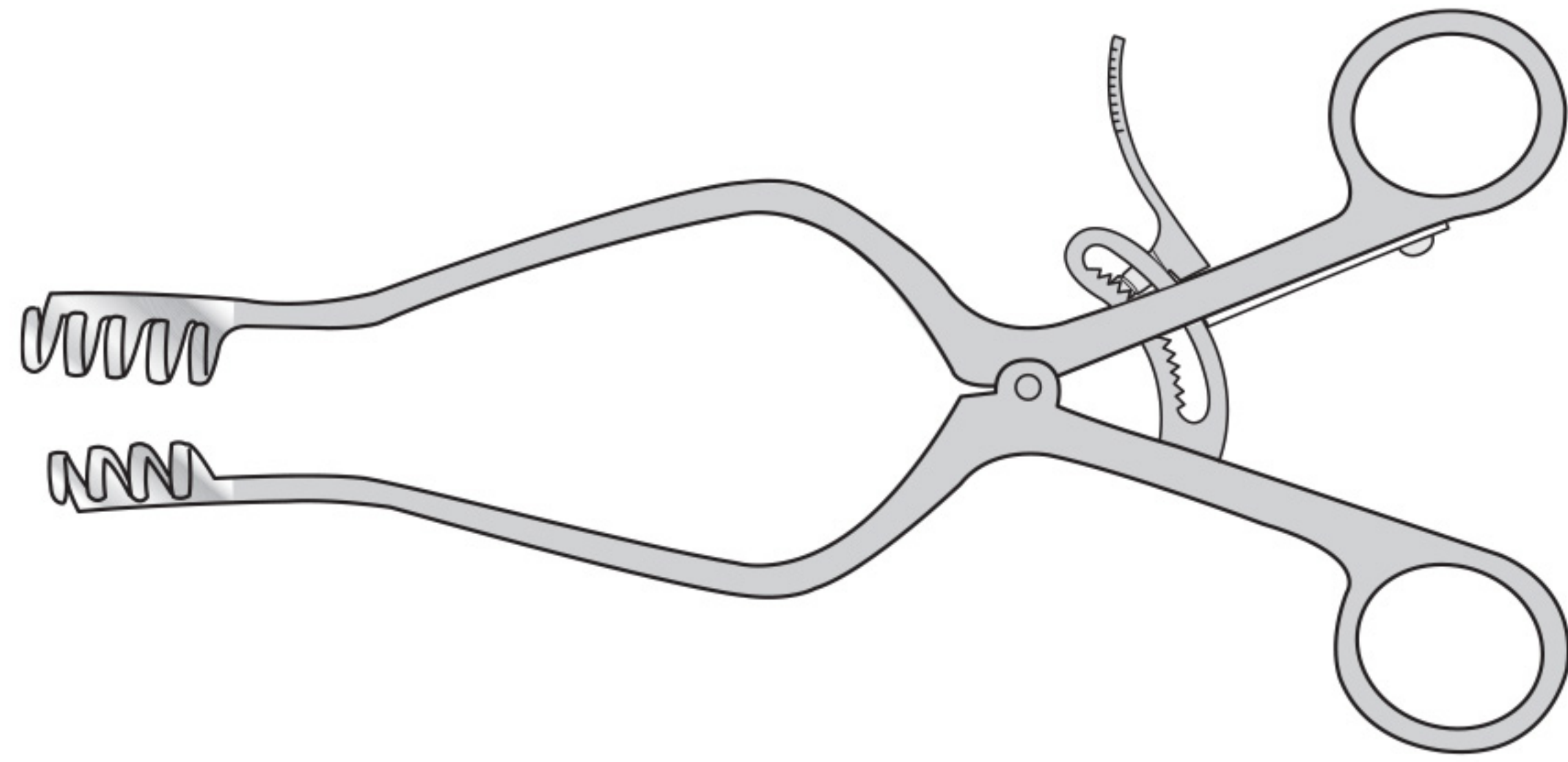

Code	Description
FST-6-495	4 x 5 teeth, 95mm fully open

Jackson Burrows Retractor

Self retaining

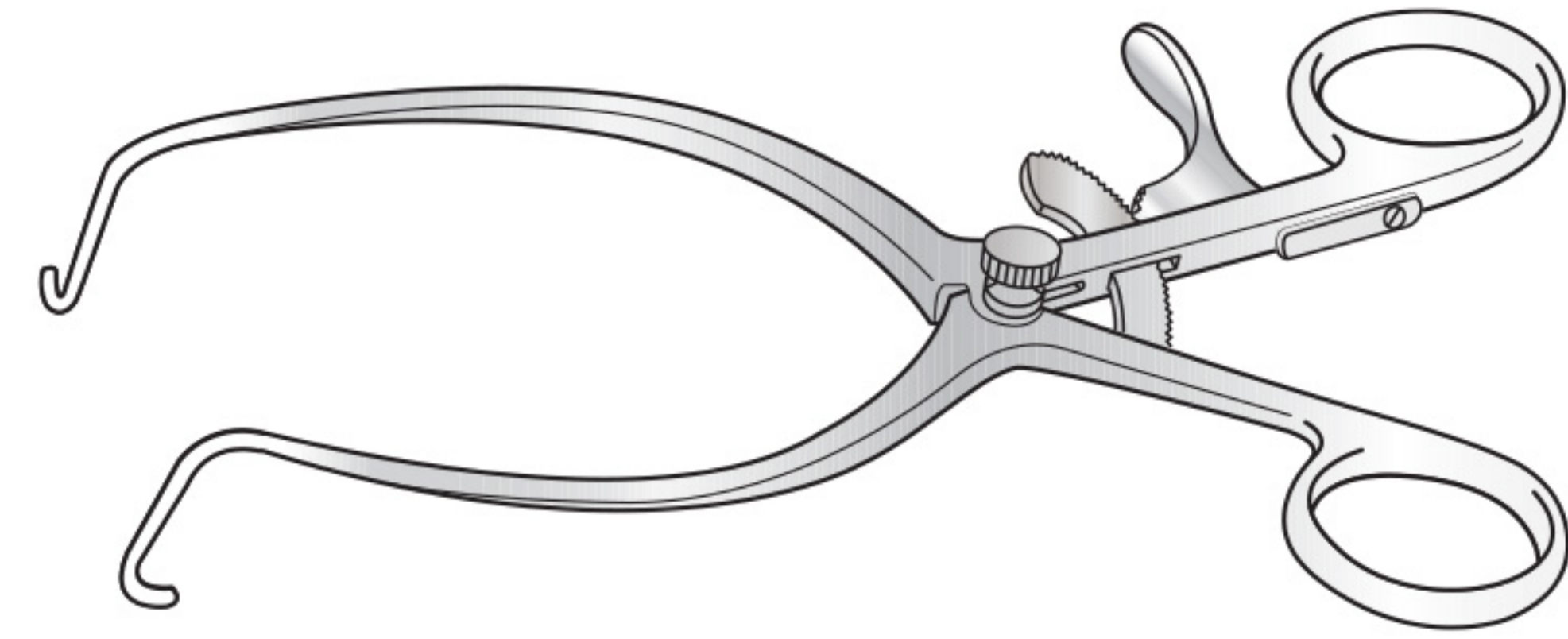

Code	Description
FST-6-496	175mm

West Retractor

Self retaining, 140mm long

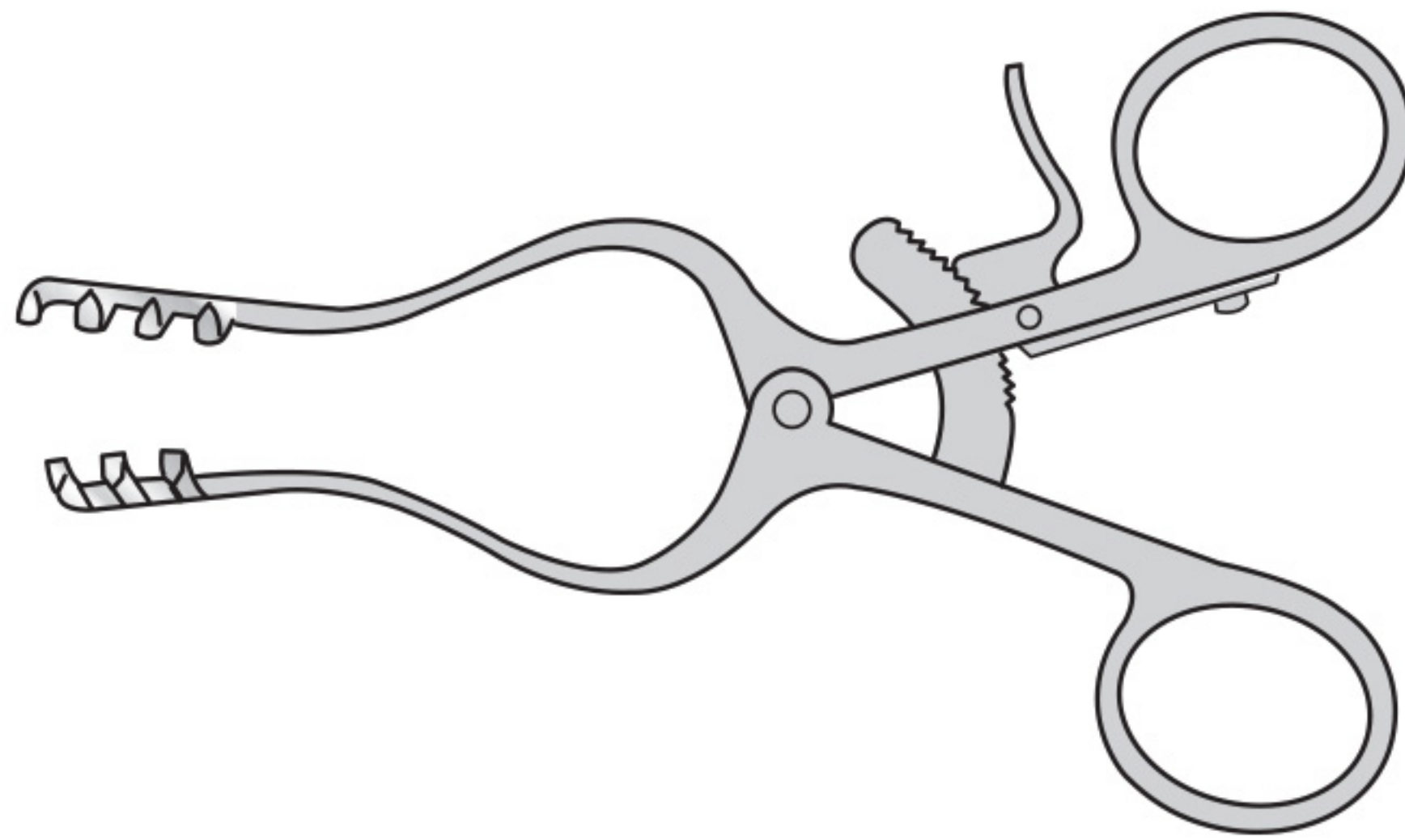

Code	Description
FST-6-497	3 x 4 teeth, 60mm fully open
FST-6-498	3 x 4 teeth, 60mm fully open, with cam rack

Norfolk and Norwich Retractor

4 x 5 teeth 50mm blades x 223mm long

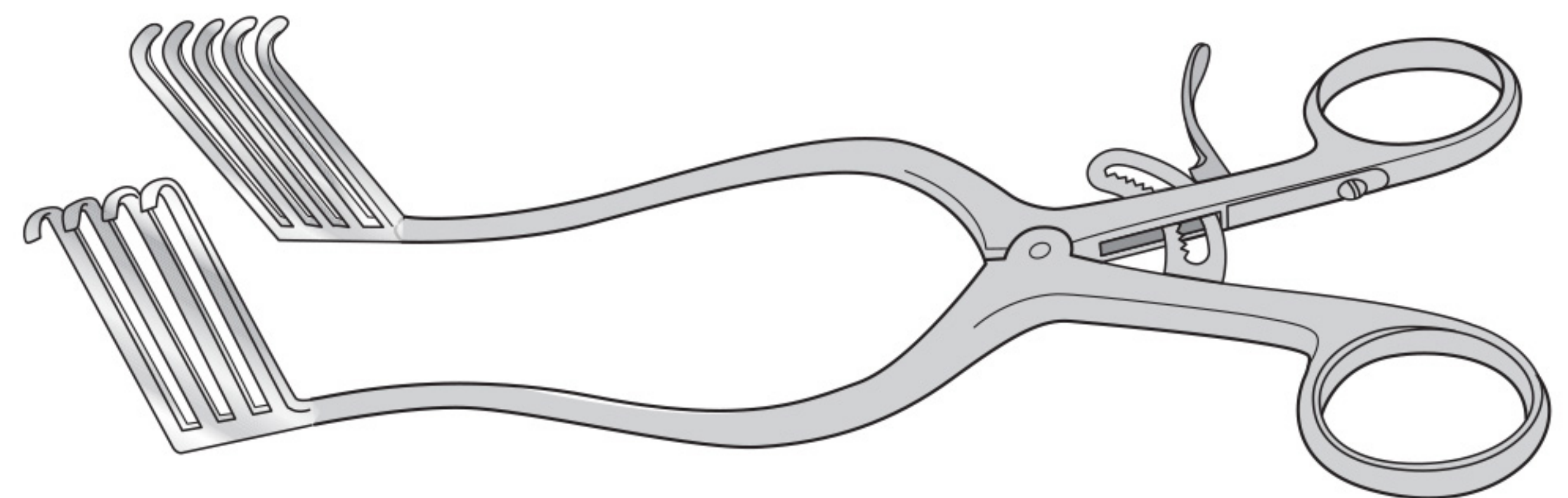

Code	Description
FST-6-499	Standard rack

Retractors, Dissecting Forceps and Hooks

Jackson Burrows Hand Retractor

225mm long

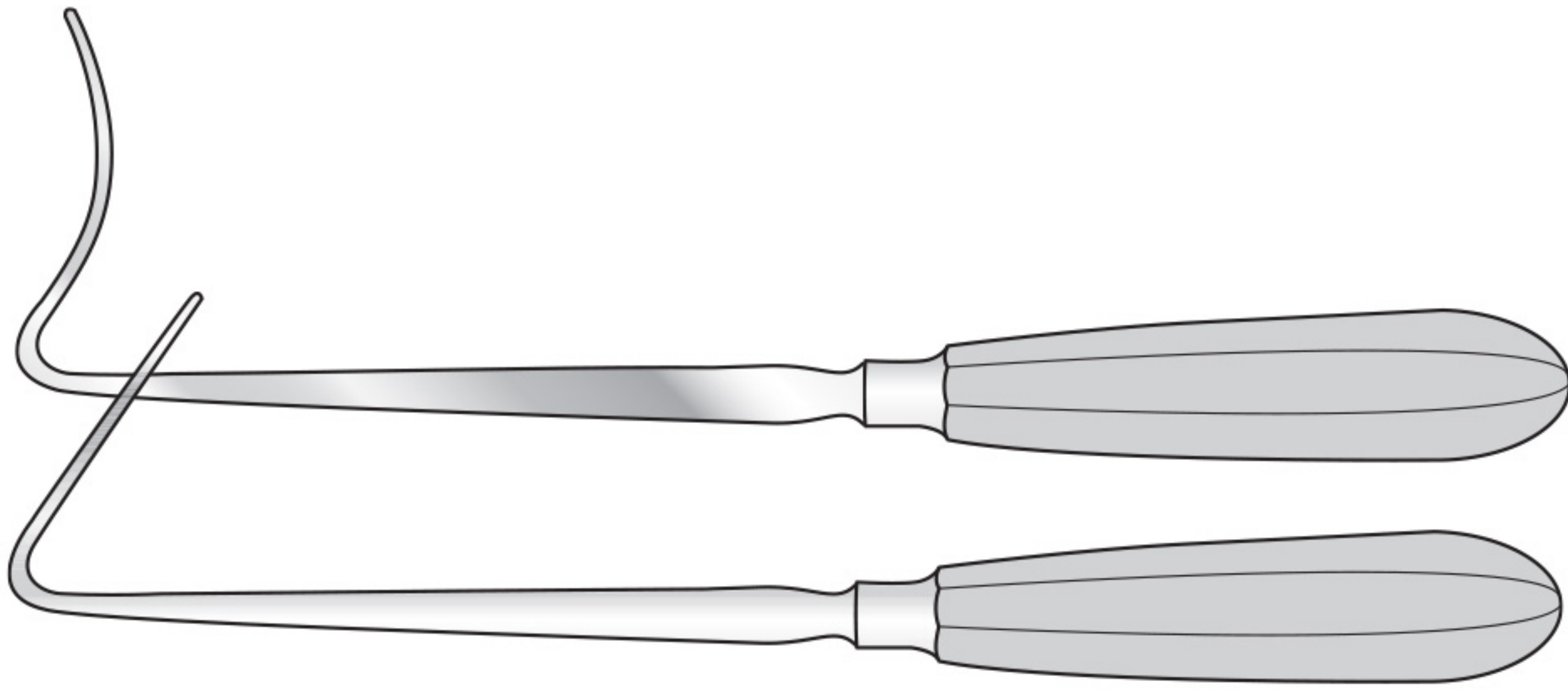

Code	Description
FST-6-505	Narrow curve, 13mm blade
FST-6-506	Broad, angular, 20mm blade

Ballance (Volkman) Retractor

203mm long

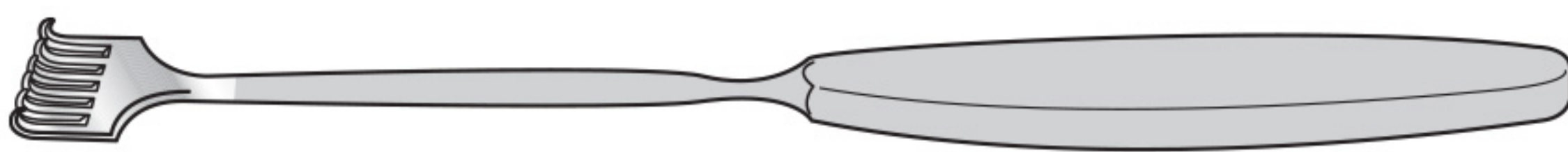

Sharp

Code	Description
FST-6-509	1 prong
FST-6-510	2 prong
FST-6-511	3 prong
FST-6-512	4 prong
FST-6-513	6 prong

Blunt

Code	Description
FST-6-514	1 prong
FST-6-515	2 prong
FST-6-516	3 prong
FST-6-517	4 prong
FST-6-518	6 prong

Jackson Burrows Dissecting Forcep

140mm long

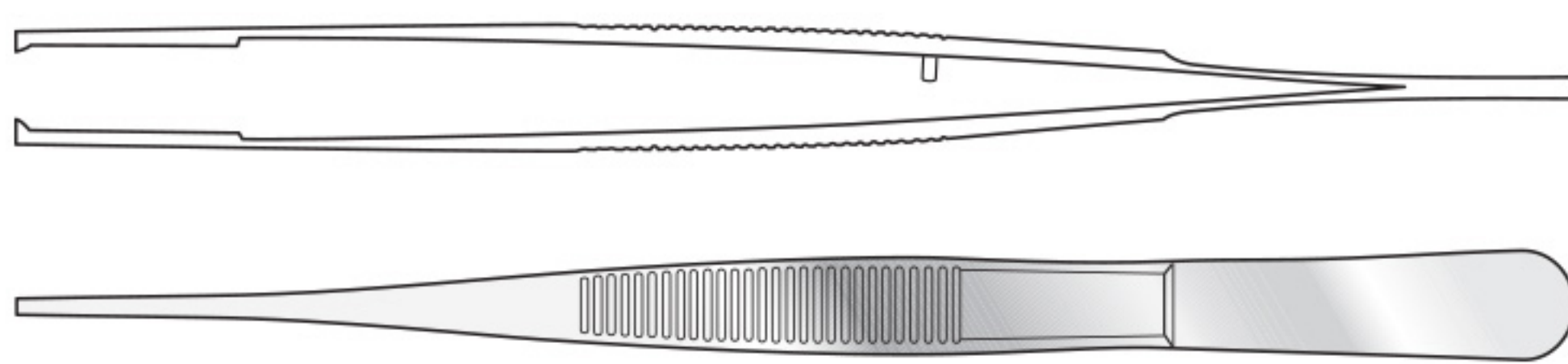

Code	Description
FST-6-520	Tongue and groove only
FST-6-521	Tongue and groove, 1-2 teeth

Charnley-McIndoe Dissecting Forceps

150mm long

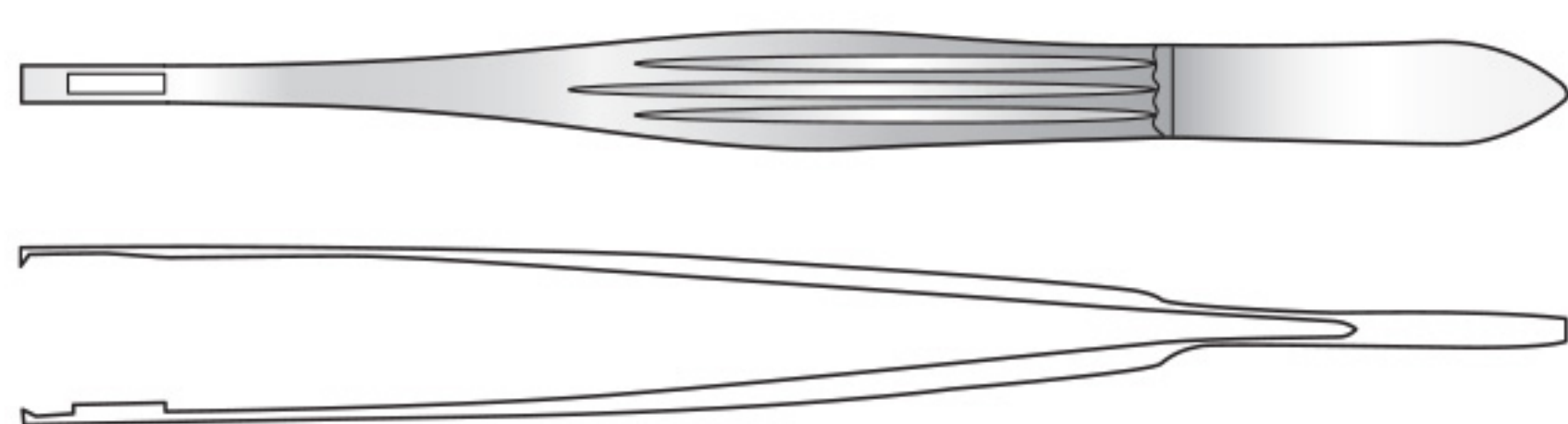

Code	Description
FST-6-523	2-3 teeth

Kocher Bone Hook

220mm long

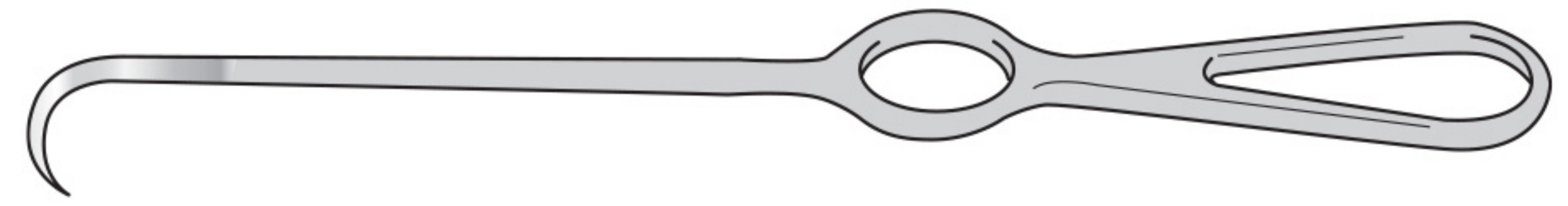

Code	Description
FST-6-507	Sharp
FST-6-508	Blunt

Langenbeck Bone Hook

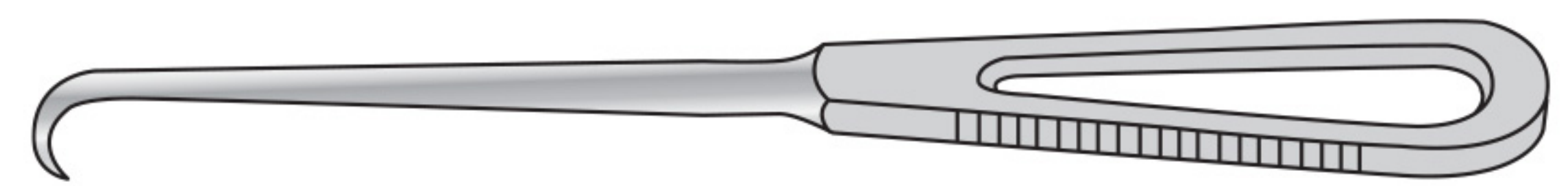

Code	Description
FST-6-519	200mm long

Dislocation Hook

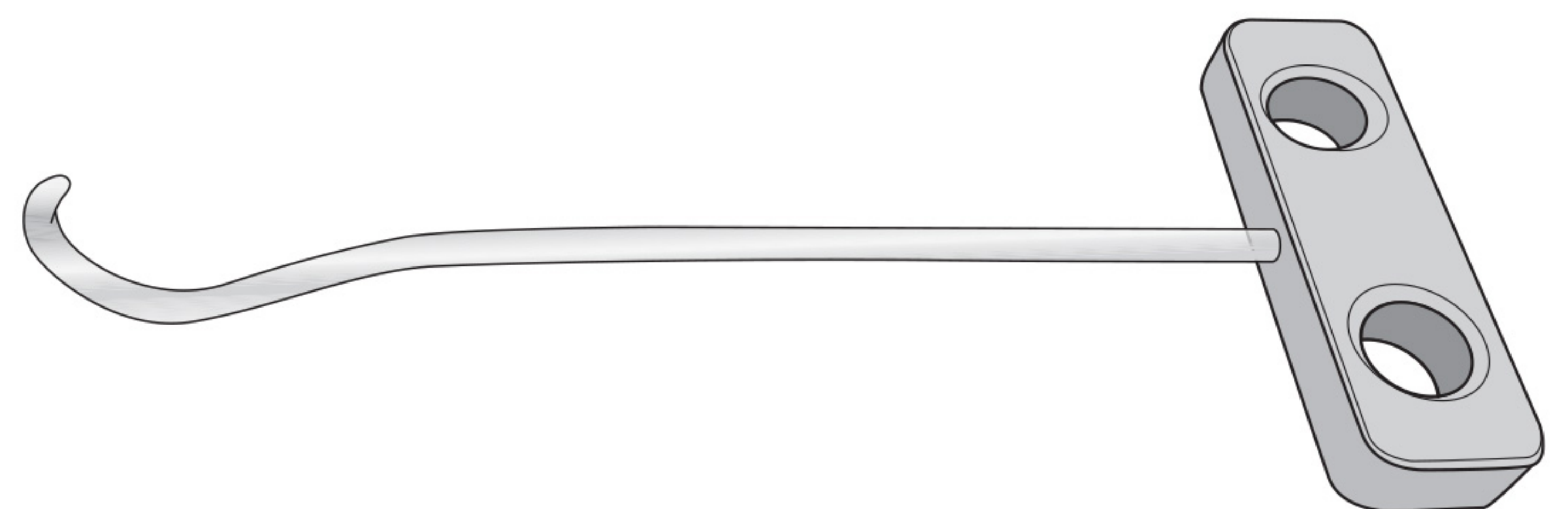

Code	Description
FST-6-522	253mm long

Dislocation Hip Hook

Blue acetal "Suregrip" handle

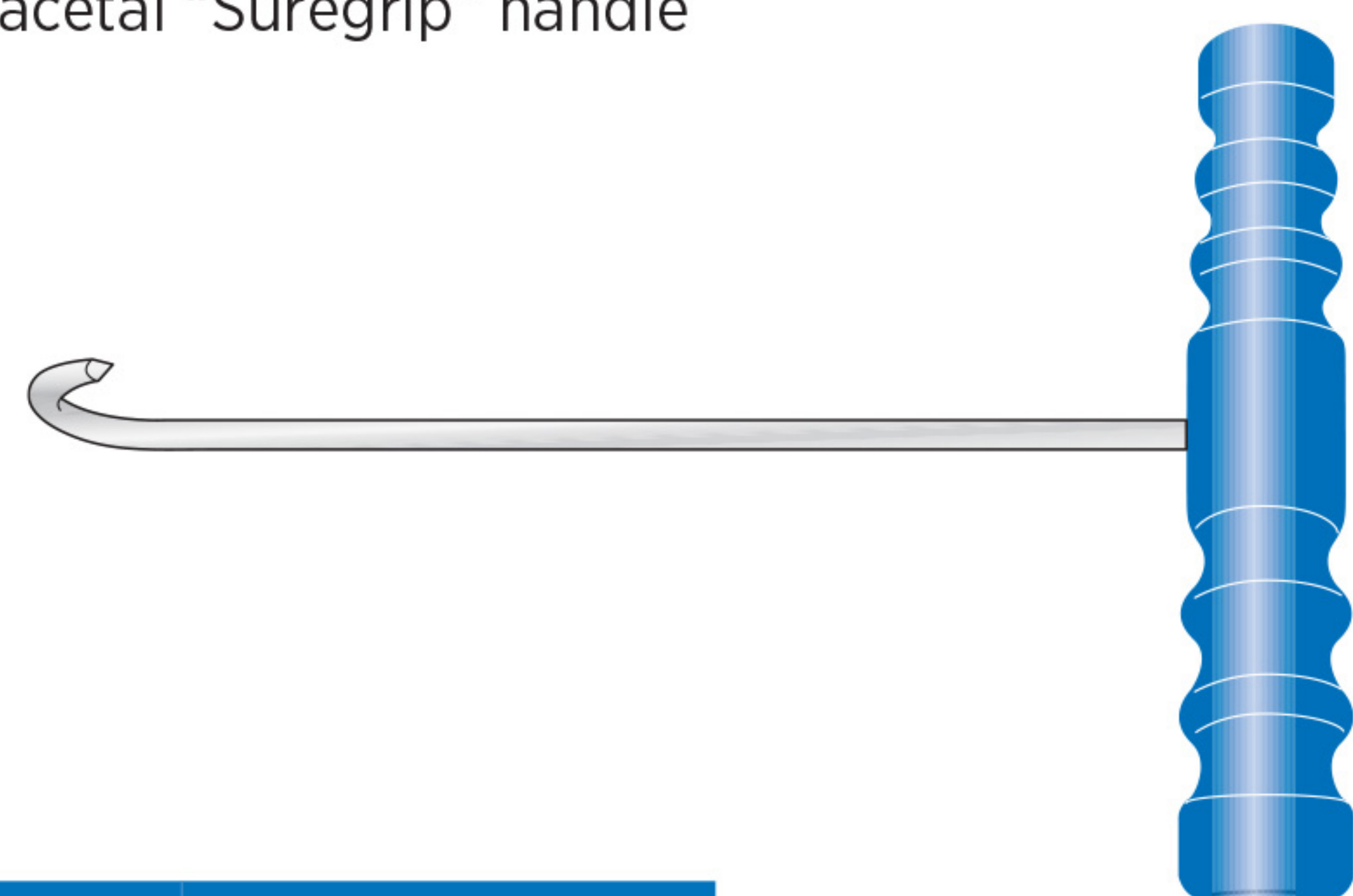

Code	Description
FST-6-524	185mm long

Key Raspatories

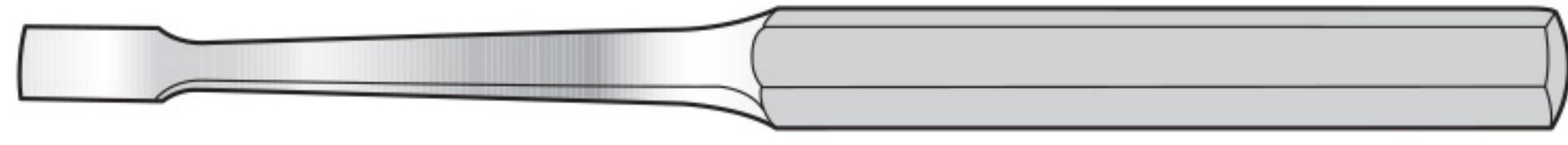

Code	Description
FST-6-530	Width 6.4mm 180mm long
FST-6-531	Width 9.5mm 190mm long
FST-6-532	Width 12.7mm 190mm long
FST-6-533	Width 19mm 200mm long
FST-6-534	Width 25.4mm 210mm long

Lambotte Raspatory

205mm Long

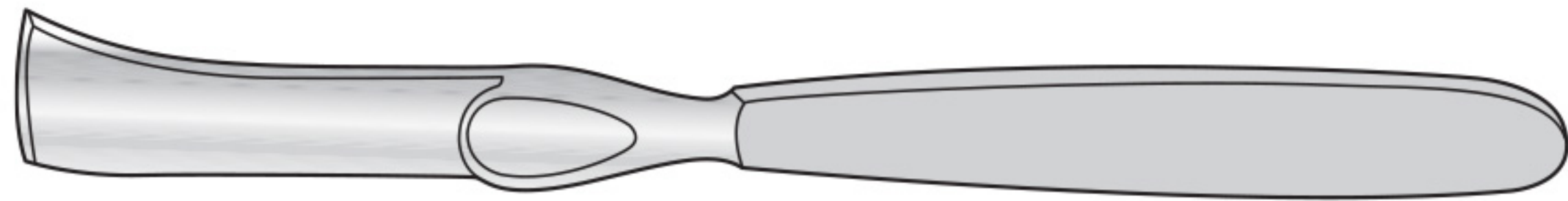

Code	Description
FST-6-536	Width 10mm
FST-6-537	Width 15mm
FST-6-538	Width 20mm

Paton Bone Burr

Satin handle, 155mm long

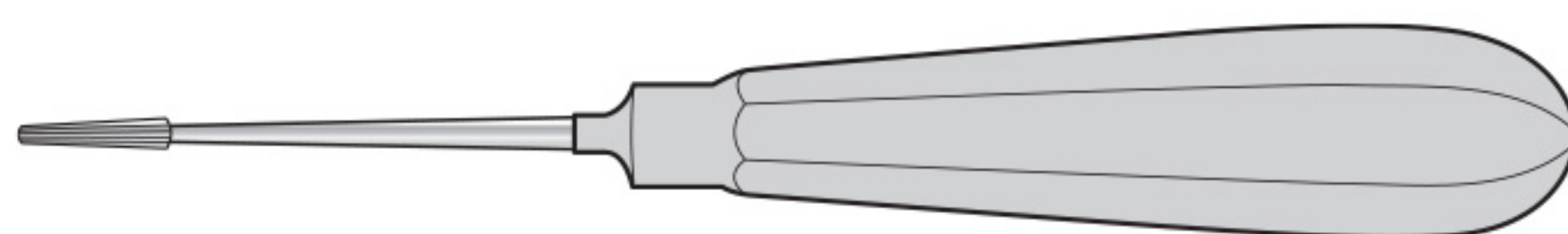

Code	Description
FST-6-540	3.5mm ø x 17mm
FST-6-541	4.5mm ø x 17mm
FST-6-542	5.0mm ø x 17mm

Robert Jones Rugine

Convex sharp edge, fan shaped end, with solid pistol handle

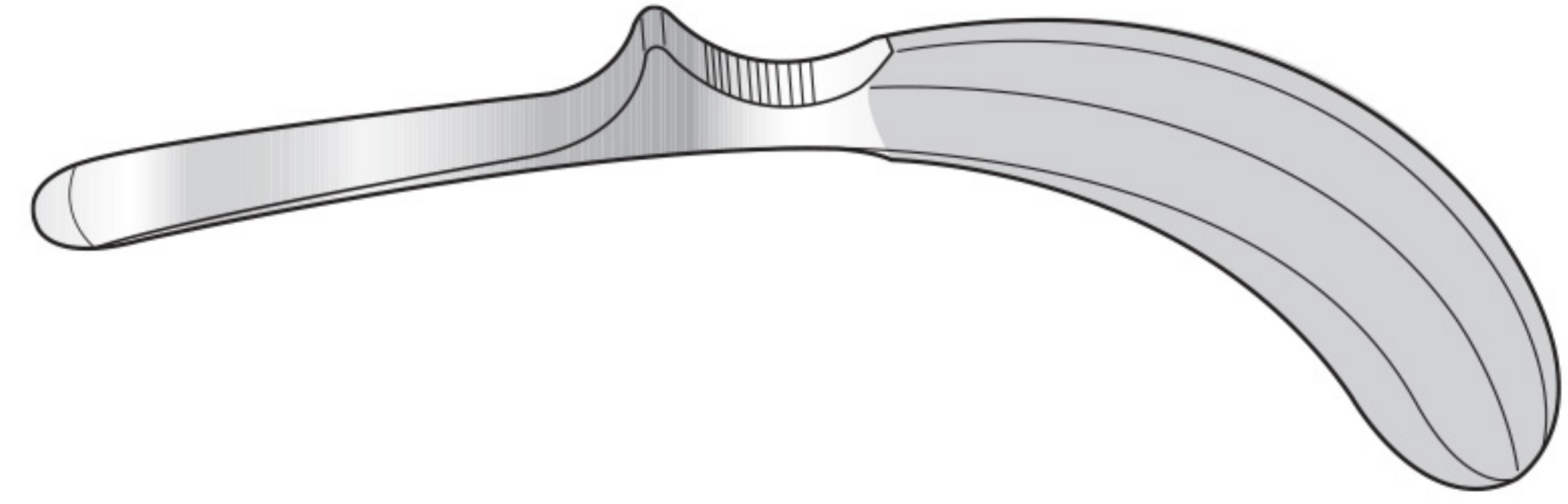

Code	Description
FST-6-535	185mm long

Mitchell Rugine

Straight, sharp edge, fan shaped, hollow handle

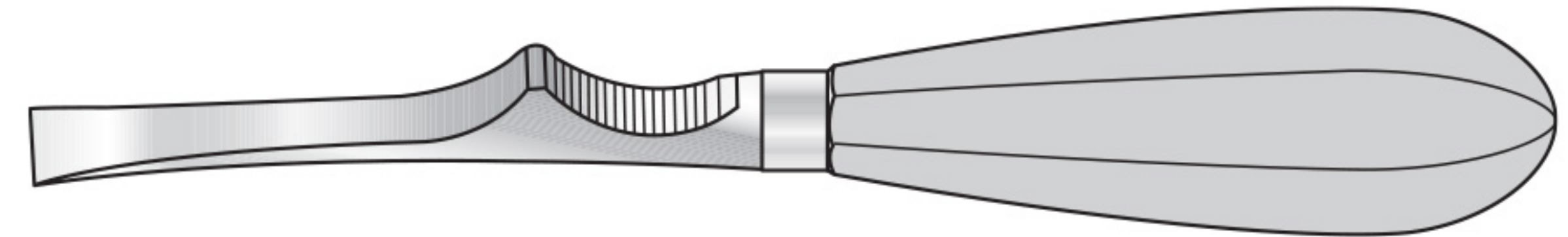

Code	Description
FST-6-539	210mm long

Farabeuf Rugine

Curved end, chisel edge, hollow handle

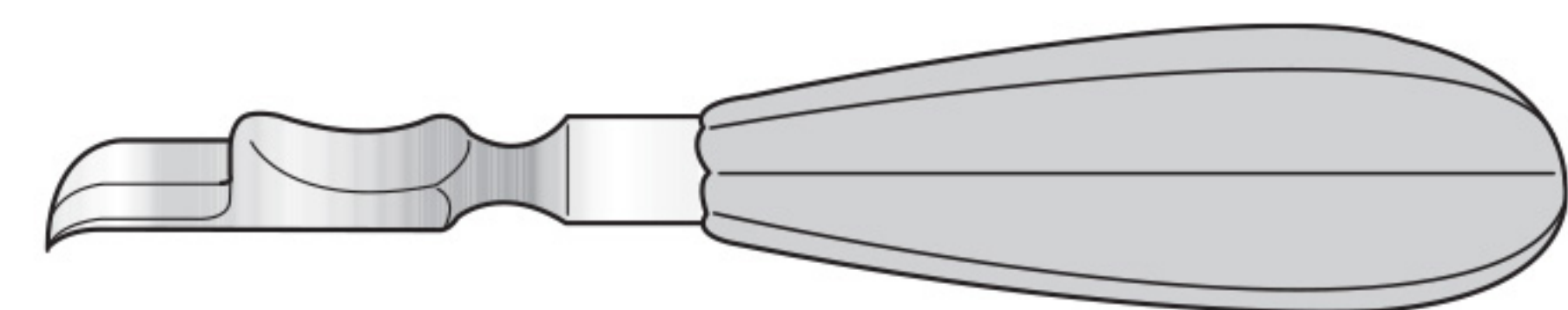

Code	Description
FST-6-543	160mm long

Osteotomes, Chisels and Gouges

Lexer Osteotome

Blue acetal "Suregrip" handle, 180mm long

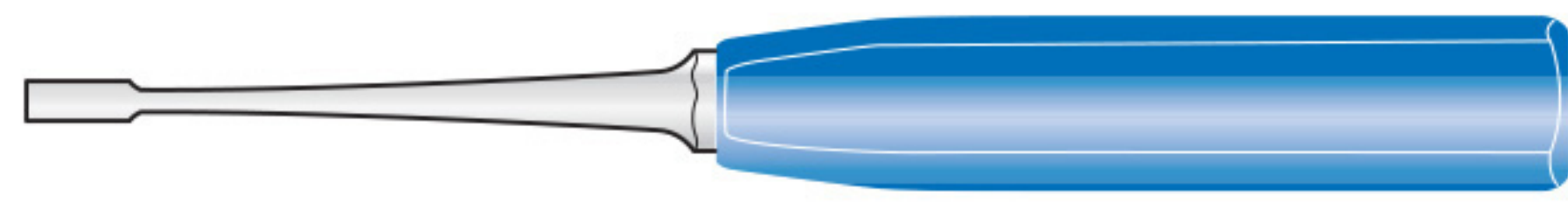

Code	Description
FST-6-550	4mm

Capener Osteotome

Blue acetal "Suregrip" handle, 250mm long

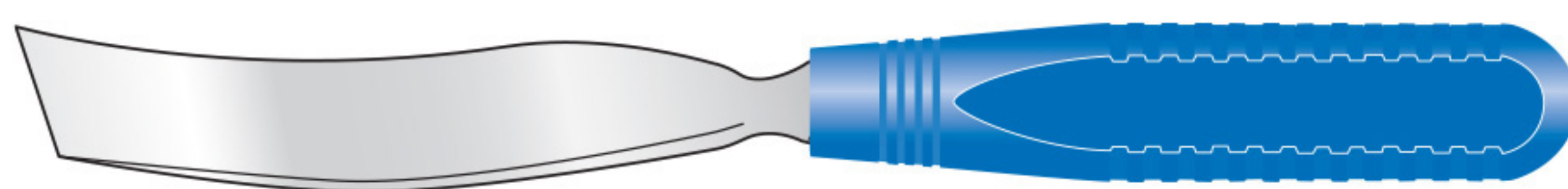

Shallow curved

Code	Description
FST-6-557	Width 6mm
FST-6-558	Width 10mm
FST-6-559	Width 12mm
FST-6-560	Width 15mm
FST-6-561	Width 20mm
FST-6-562	Width 25mm
FST-6-563	Width 30mm

Acute curved

Code	Description
FST-6-564	Width 6mm
FST-6-565	Width 10mm
FST-6-566	Width 15mm
FST-6-567	Width 20mm
FST-6-568	Width 25mm

Capener Osteotome

Blue acetal "Suregrip" handle, straight, 255mm long

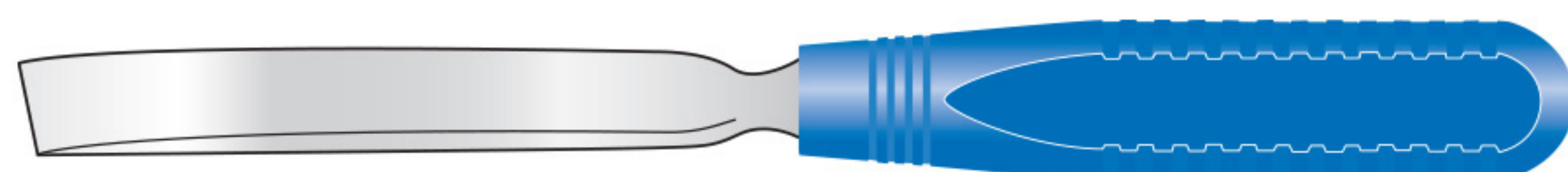

Code	Description	Code	Description
FST-6-581	Width 6mm	FST-6-586	Width 15mm
FST-6-582	Width 8mm	FST-6-587	Width 18mm
FST-6-583	Width 10mm	FST-6-588	Width 20mm
FST-6-584	Width 12mm	FST-6-589	Width 25mm
FST-6-585	Width 13mm	FST-6-590	Width 30mm

Capener Chisel

Blue acetal "Suregrip" handle straight, 250mm long

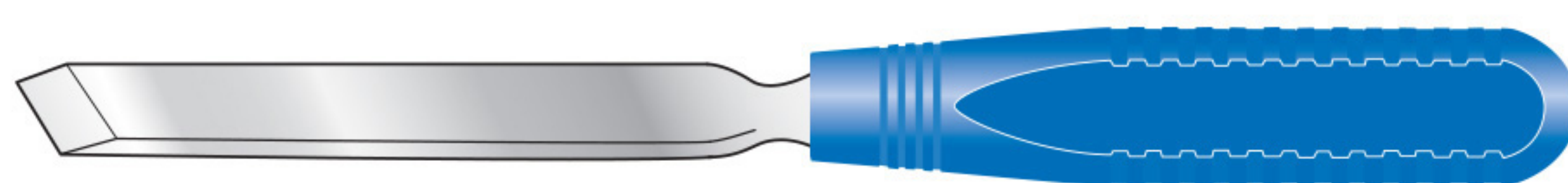

Code	Description	Code	Description
FST-6-592	Width 6mm	FST-6-595	Width 15mm
FST-6-593	Width 10mm	FST-6-596	Width 20mm
FST-6-594	Width 12mm	FST-6-597	Width 25mm

Capener Lamina Gouge

Blue acetal "Suregrip" handle, straight, 265mm long

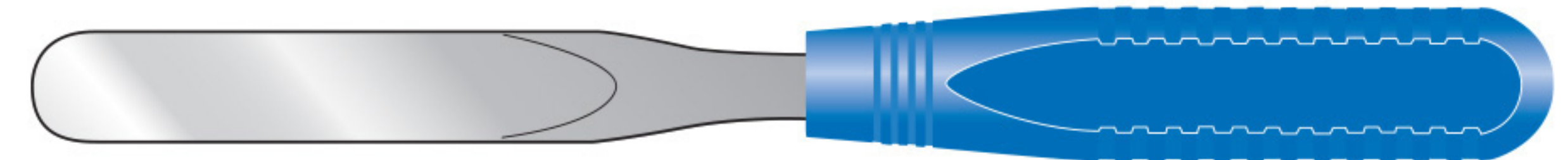

Code	Description	Code	Description
FST-6-551	Width 6mm	FST-6-554	Width 15mm
FST-6-552	Width 10mm	FST-6-555	Width 20mm
FST-6-553	Width 12mm	FST-6-556	Width 25mm

Capener Lamina Gouge

Cranked, blue acetal "Suregrip" handle, 250mm long

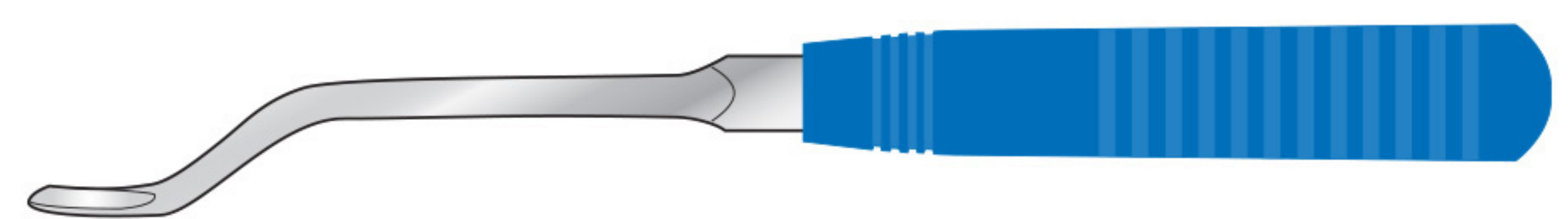

With reversed edge

Code	Description	Code	Description
FST-6-569	Width 6mm	FST-6-575	Width 6mm
FST-6-570	Width 8mm	FST-6-576	Width 8mm
FST-6-571	Width 10mm	FST-6-577	Width 10mm
FST-6-572	Width 11mm	FST-6-578	Width 11mm
FST-6-573	Width 16mm	FST-6-579	Width 16mm
FST-6-574	Width 17mm	FST-6-580	Width 17mm

OTHER LENGTHS AND SIZES AVAILABLE

Capener Lamina Gouge

Swan neck, blue acetal "Suregrip" handle, 250mm long

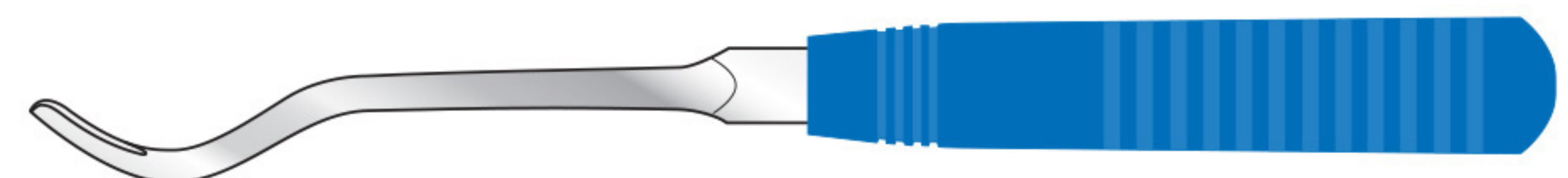

Code	Description
FST-6-591	Width 8mm

Capener Lamina Gouge

Reverse cranked, blue acetal "Suregrip" handle, 245mm long

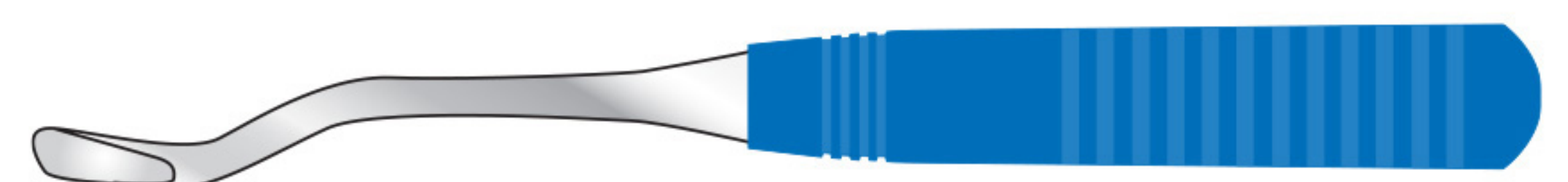

Code	Description	Code	Description
FST-6-598	Width 11mm	FST-6-601	Width 6mm
FST-6-599	Width 16mm	FST-6-602	Width 8mm
FST-6-600	Width 17mm	FST-6-603	Width 10mm

Read Osteotome

Serrated head
180mm long

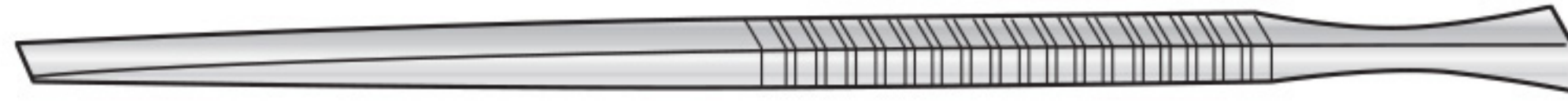

Code	Description
FST-6-610	Width 4mm
FST-6-611	Width 5mm

Read Gouge

Serrated head, 180mm long

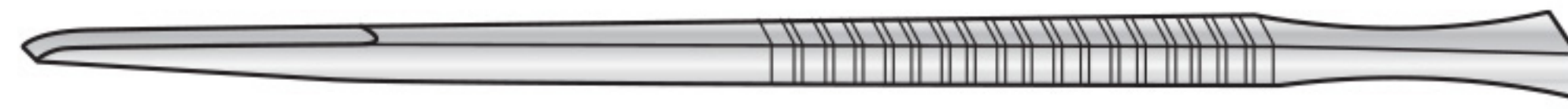

Code	Description
FST-6-622	Width 2mm
FST-6-623	Width 3mm
FST-6-624	Width 4mm
FST-6-625	Width 5mm

Code	Description
FST-6-626	Width 6mm
FST-6-627	Width 7mm
FST-6-628	Width 8mm

Read Chisel

Serrated head, 180mm long

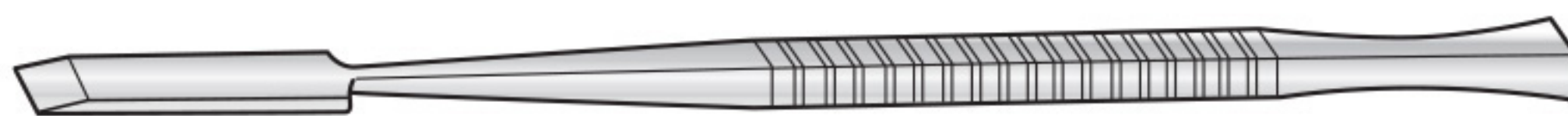

Code	Description
FST-6-637	Width 2mm
FST-6-638	Width 3mm
FST-6-639	Width 4mm
FST-6-640	Width 5mm

Code	Description
FST-6-641	Width 6mm
FST-6-642	Width 7mm
FST-6-643	Width 8mm

Swedish Pattern Osteotome

200mm long

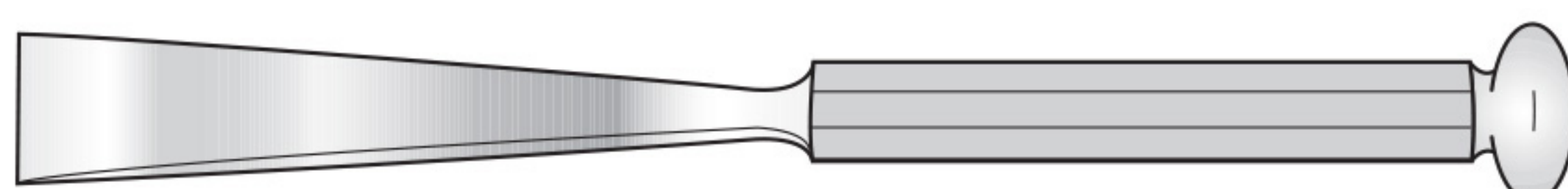

Code	Description
FST-6-662	Width 10mm
FST-6-663	Width 15mm
FST-6-664	Width 20mm
FST-6-665	Width 25mm
FST-6-666	Width 30mm

With tungsten carbide edge

Code	Description
FST-6-667	Width 10mm
FST-6-668	Width 15mm
FST-6-669	Width 20mm
FST-6-670	Width 25mm
FST-6-671	Width 30mm

Swedish Pattern Chisel

200mm long

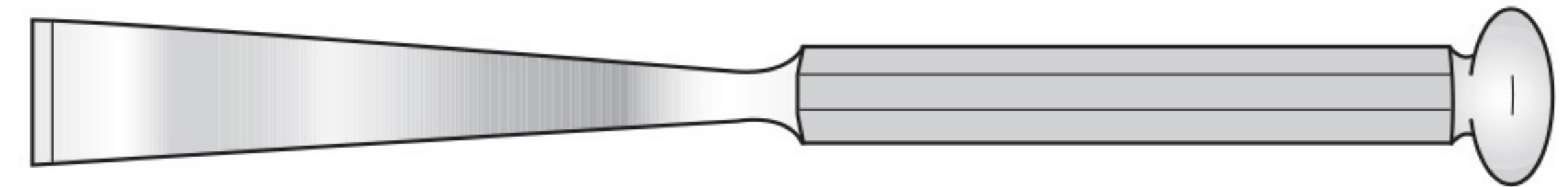

With tungsten carbide edge

Code	Description
FST-6-612	Width 10mm
FST-6-613	Width 15mm
FST-6-614	Width 20mm
FST-6-615	Width 25mm
FST-6-616	Width 30mm

Code	Description
FST-6-617	Width 20mm
FST-6-618	Width 25mm
FST-6-619	Width 30mm
FST-6-620	Width 25mm
FST-6-621	Width 30mm

Swedish Pattern Gouge

200mm long

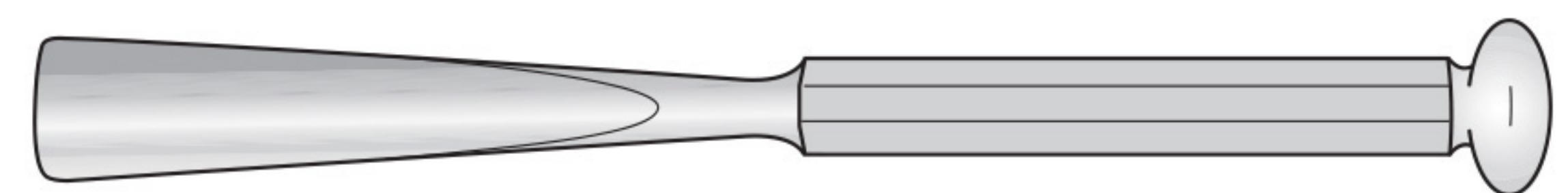

With tungsten carbide edge

Code	Description
FST-6-629	Width 10mm
FST-6-630	Width 15mm
FST-6-631	Width 20mm
FST-6-632	Width 25mm

Code	Description
FST-6-633	Width 10mm
FST-6-634	Width 15mm
FST-6-635	Width 20mm
FST-6-636	Width 25mm

Lambotte Osteotome

230mm long



Straight

Code	Description
FST-6-644	2mm wide
FST-6-645	4mm wide
FST-6-646	7mm wide
FST-6-647	15mm wide
FST-6-648	20mm wide
FST-6-649	25mm wide
FST-6-650	30mm wide
FST-6-651	38mm wide
FST-6-652	44mm wide
FST-6-653	50mm wide

Curved

Code	Description
FST-6-654	15mm wide
FST-6-655	20mm wide
FST-6-656	25mm wide
FST-6-657	30mm wide
FST-6-658	38mm wide
FST-6-659	40mm wide
FST-6-660	44mm wide
FST-6-661	50mm wide



Address: P.O Box 2953, 6 Awan Street Ugoki Road,
Shahab Pura Sialkot - Pakistan



Phone: +92 52 325 7510



Phone: +92 52 324 1879



Email: info@fstinternational.com



website: www.fstinternational.com

