



# TABLE OF CONTACTS

## *GYNAECOLOGY*

<b>1</b>	<b>Clamps</b>	<b>03</b>
<b>2</b>	<b>Forceps</b>	<b>04-05-06-07</b>
<b>3</b>	<b>Biopsy Forceps</b>	<b>08-09</b>
<b>4</b>	<b>Cervical Forceps</b>	<b>10</b>
<b>5</b>	<b>Obstetric Forceps</b>	<b>11</b>
<b>6</b>	<b>Speculum</b>	<b>12-13</b>
<b>7</b>	<b>Retractors</b>	<b>14-15</b>
<b>8</b>	<b>Curettes</b>	<b>16</b>
<b>9</b>	<b>Catheters</b>	<b>17-18</b>
<b>10</b>	<b>Scissors</b>	<b>19</b>
<b>11</b>	<b>Miscellaneous</b>	<b>20</b>
<b>12</b>	<b>Dilators and Sounds</b>	<b>21</b>



# Clamps and Forceps

## Parametrium Clamp Forceps

Hysterectomy clamp,  
atraumatic jaws,  
two gold bows

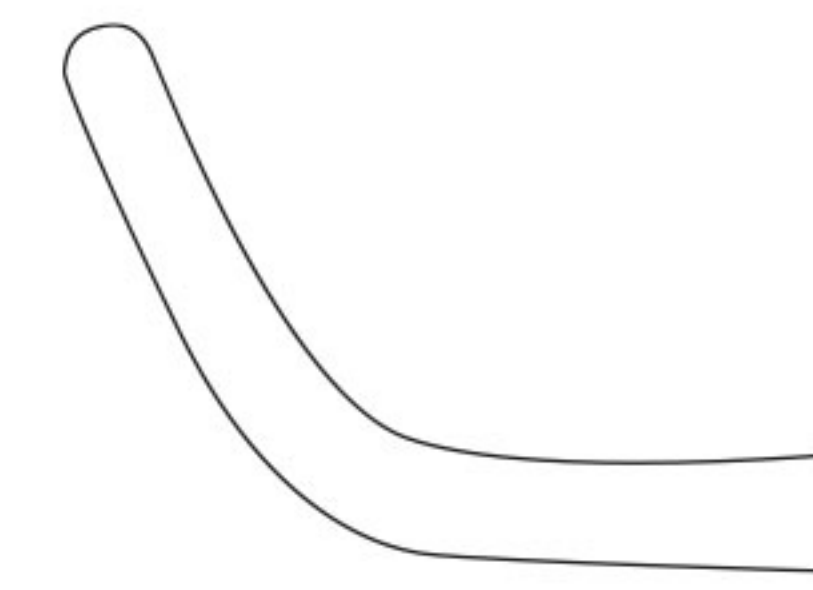
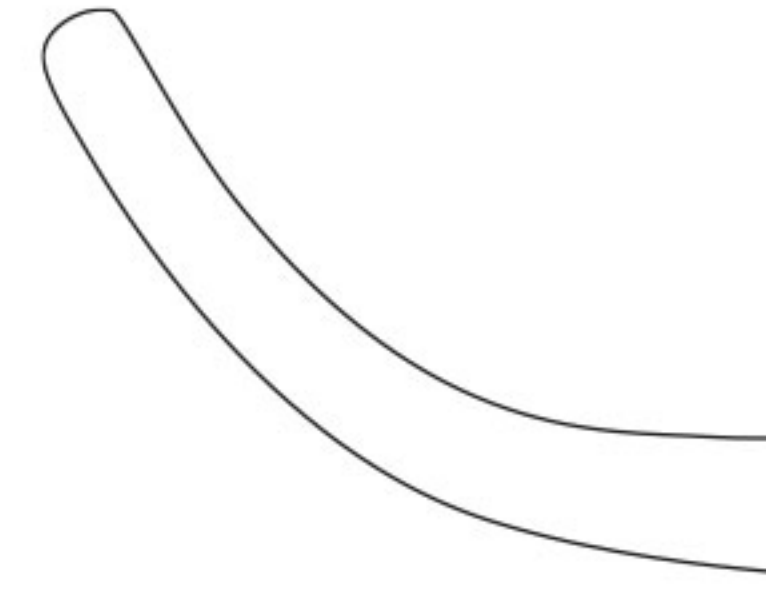
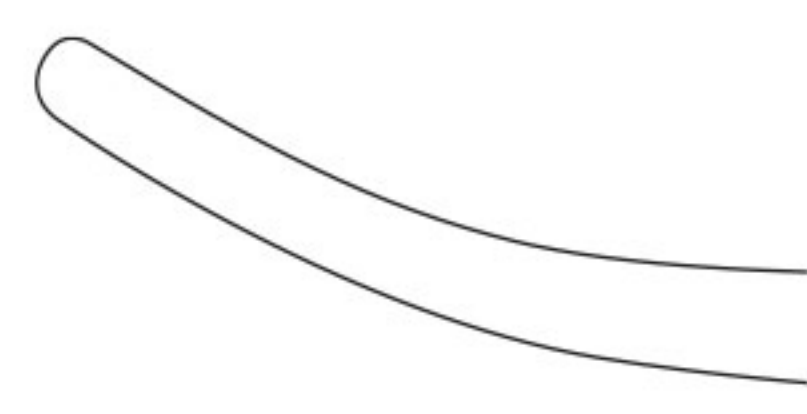
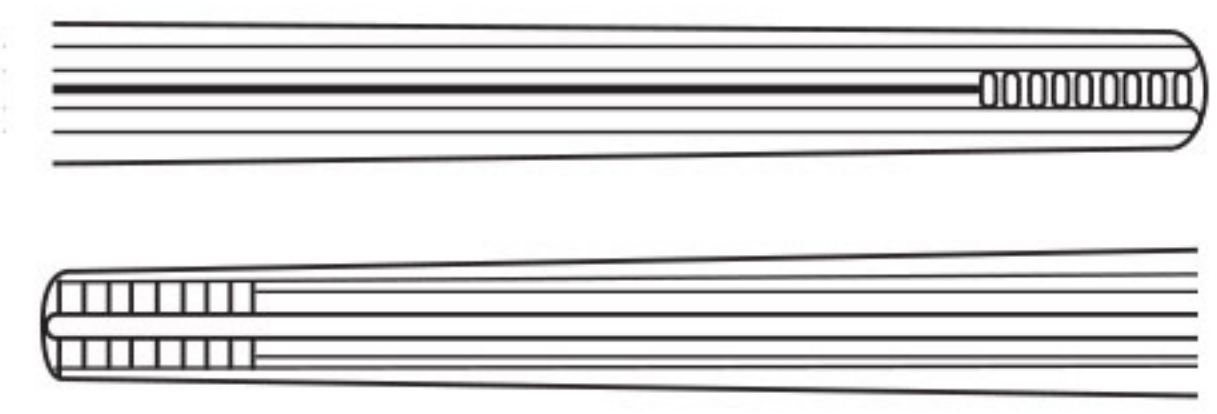
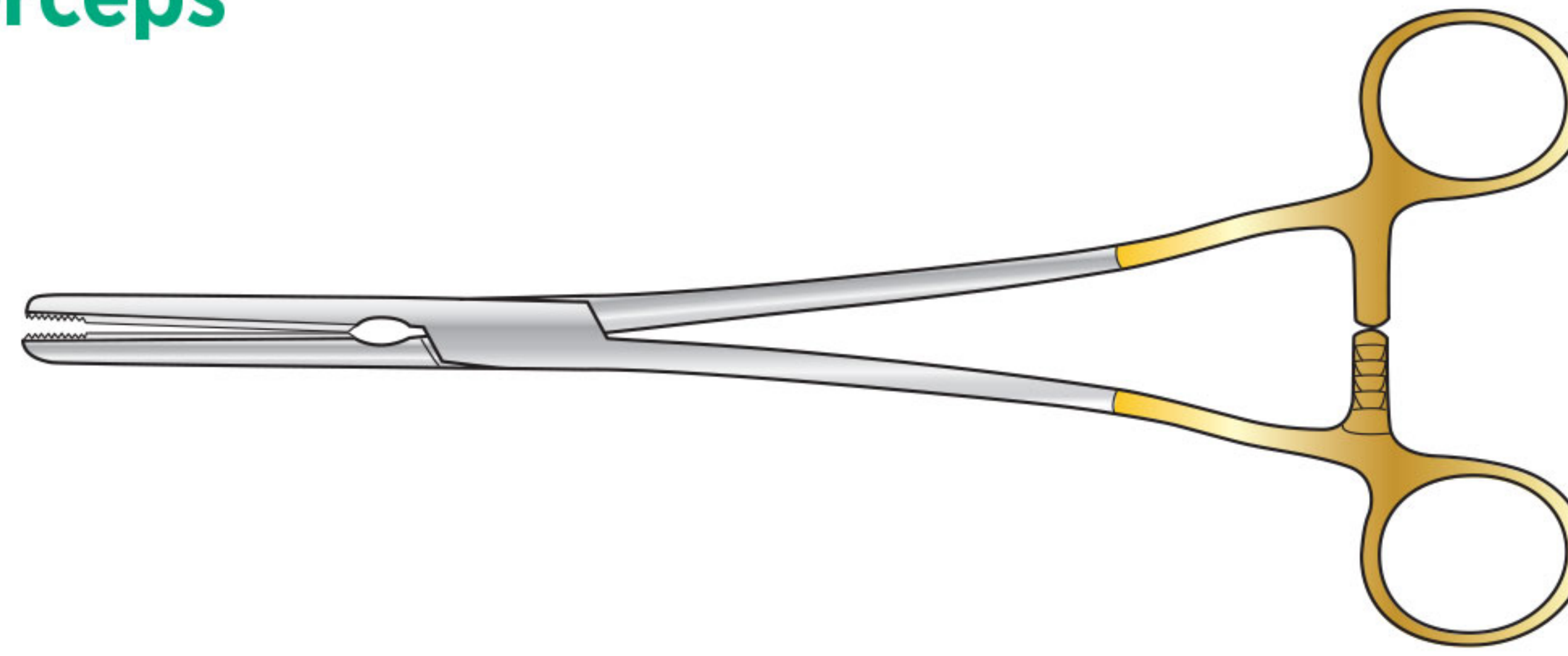

### Straight

Code	Description
FST-3-101	203mm long
FST-3-102	233mm long
FST-3-103	254mm long
FST-3-104	304mm long
FST-3-105	360mm long

### Slight curve

Code	Description
FST-3-106	203mm long
FST-3-107	233mm long
FST-3-108	254mm long
FST-3-109	304mm long
FST-3-110	360mm long

### Strong curve

Code	Description
FST-3-111	203mm long
FST-3-112	233mm long
FST-3-113	254mm long
FST-3-114	360mm long

### Angled

Code	Description
FST-3-115	203mm long
FST-3-116	233mm long
FST-3-117	254mm long
FST-3-118	304mm long
FST-3-119	360mm long

## Spencer-Robarts Clamp

For endometrial and pedunculated fibroid polyps, with  
ratchet jaw-locking mechanism, and 50° jaw opening

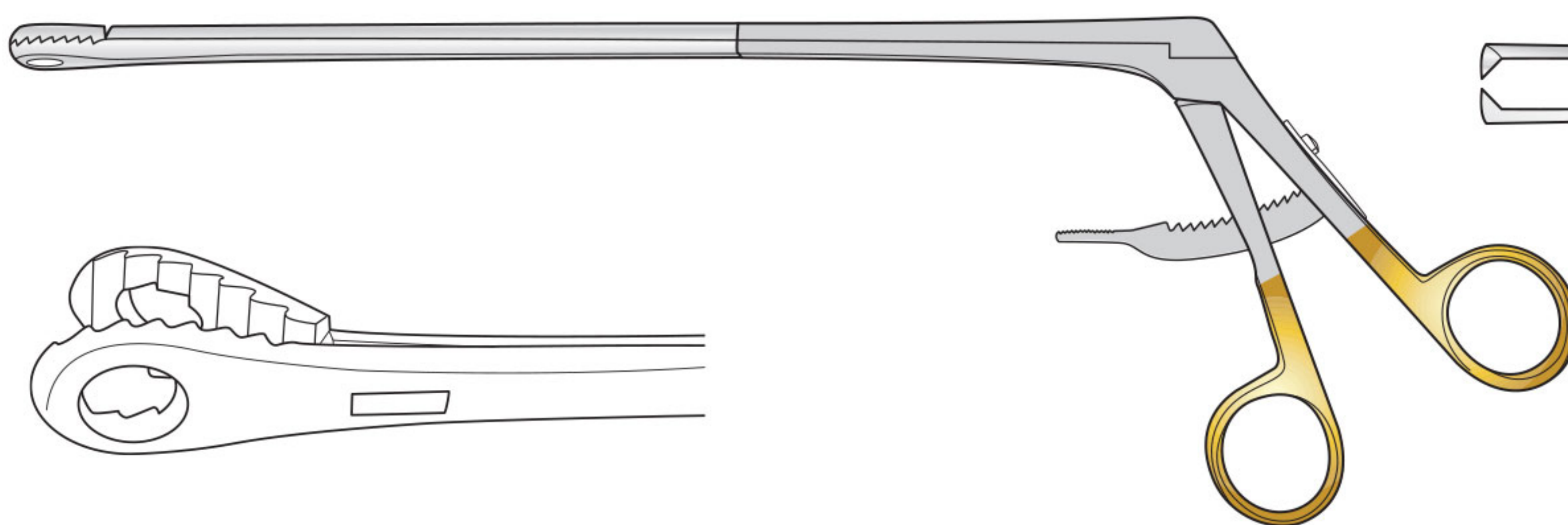

Code	Description
FST-3-125	Shaft 235mm long

## Museux Vulsellum Forceps

Matt finish

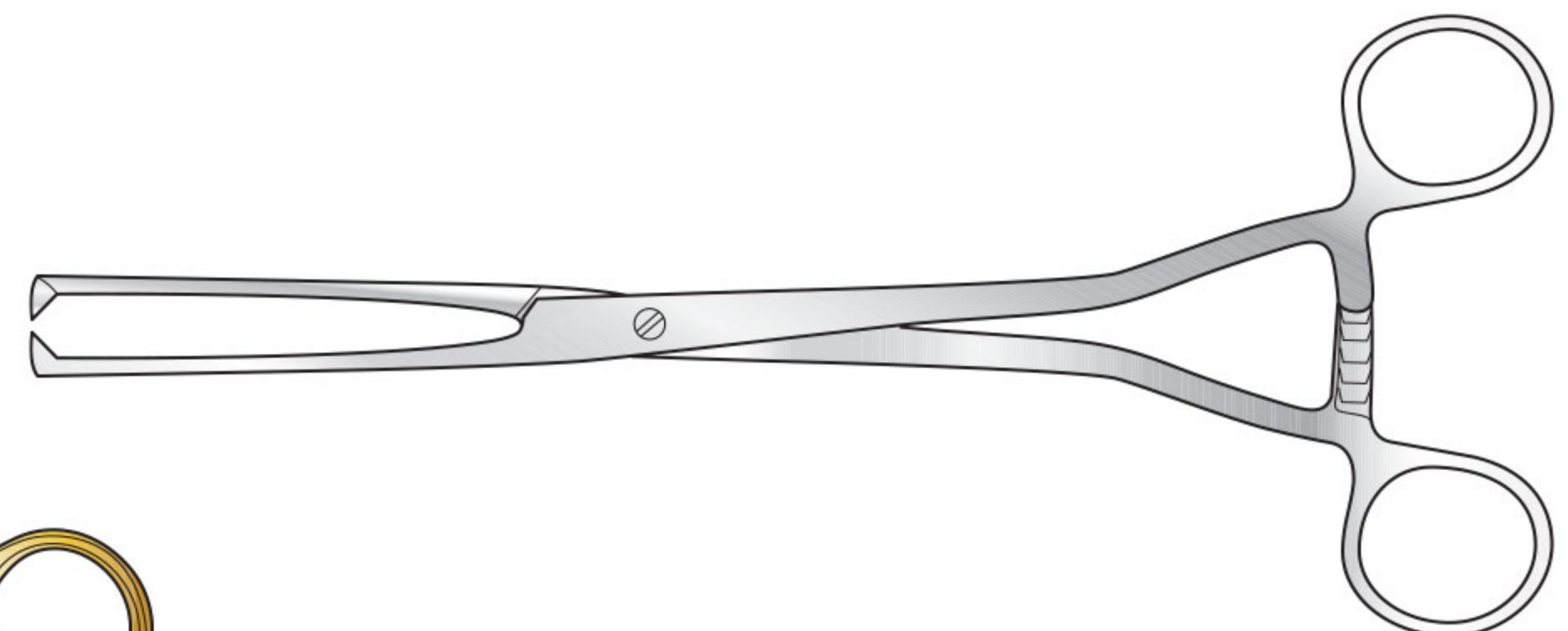

Code	Description
FST-3-125	240mm long

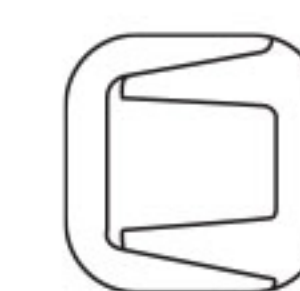

## Schroeder Uterine Vulsellum Forcep

1-1 teeth

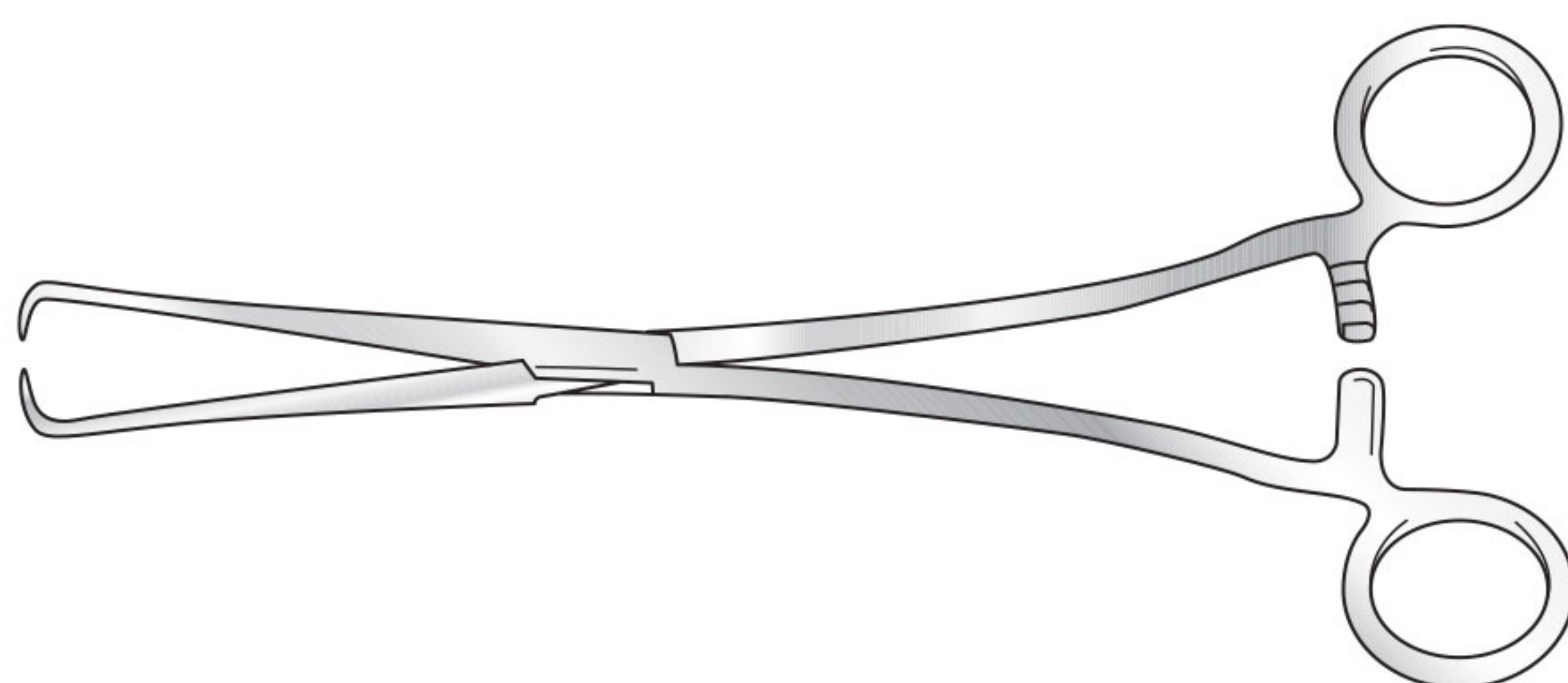

Code	Description
FST-3-130	229mm long

## Teale Uterine Vulsellum Forcep

3-4 teeth, 230mm long

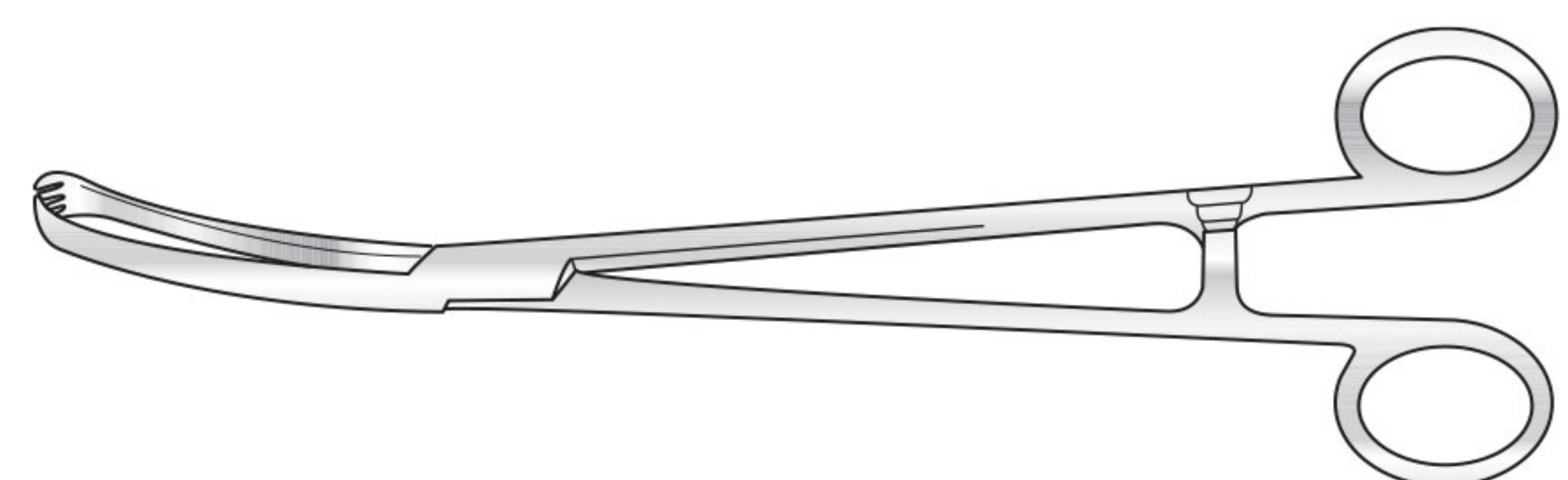

Code	Description
FST-3-134	Curved
FST-3-135	Straight



### Bonney Hysterectomy Forceps

Angled on flat, 1 - 2 teeth

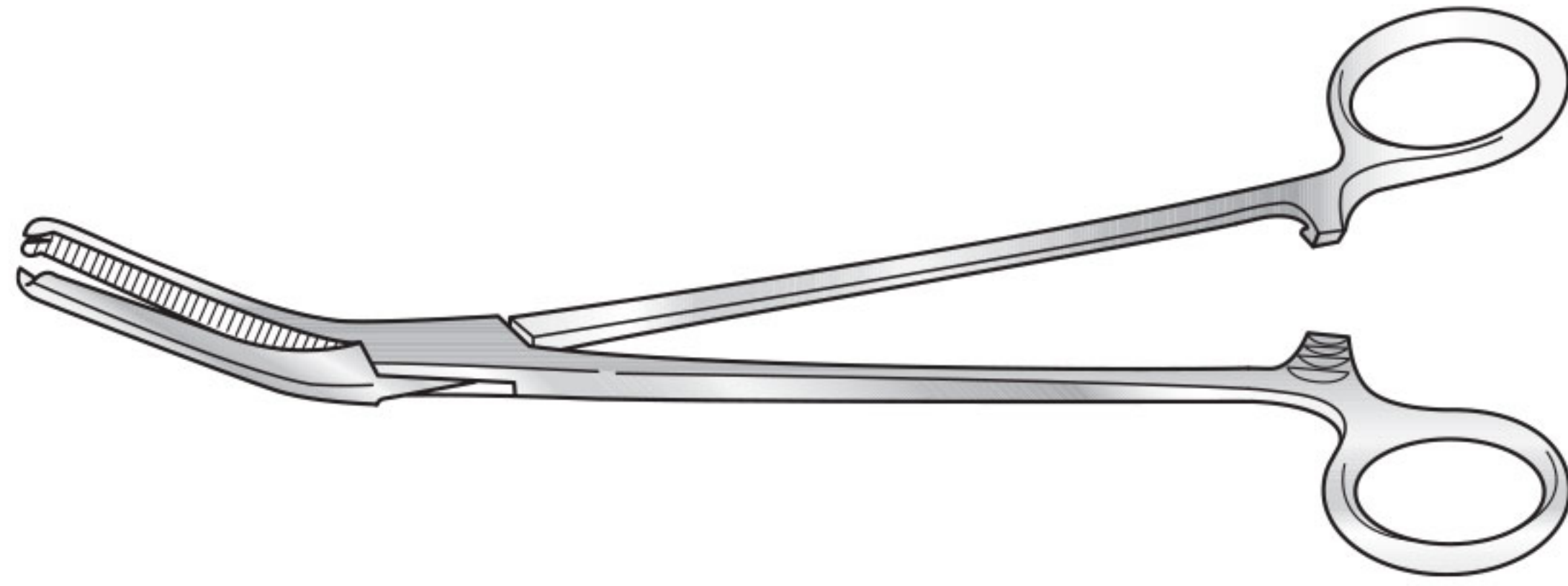

Code	Description
FST-3-150	197mm long

### Maingot Hysterectomy Forceps

203mm long

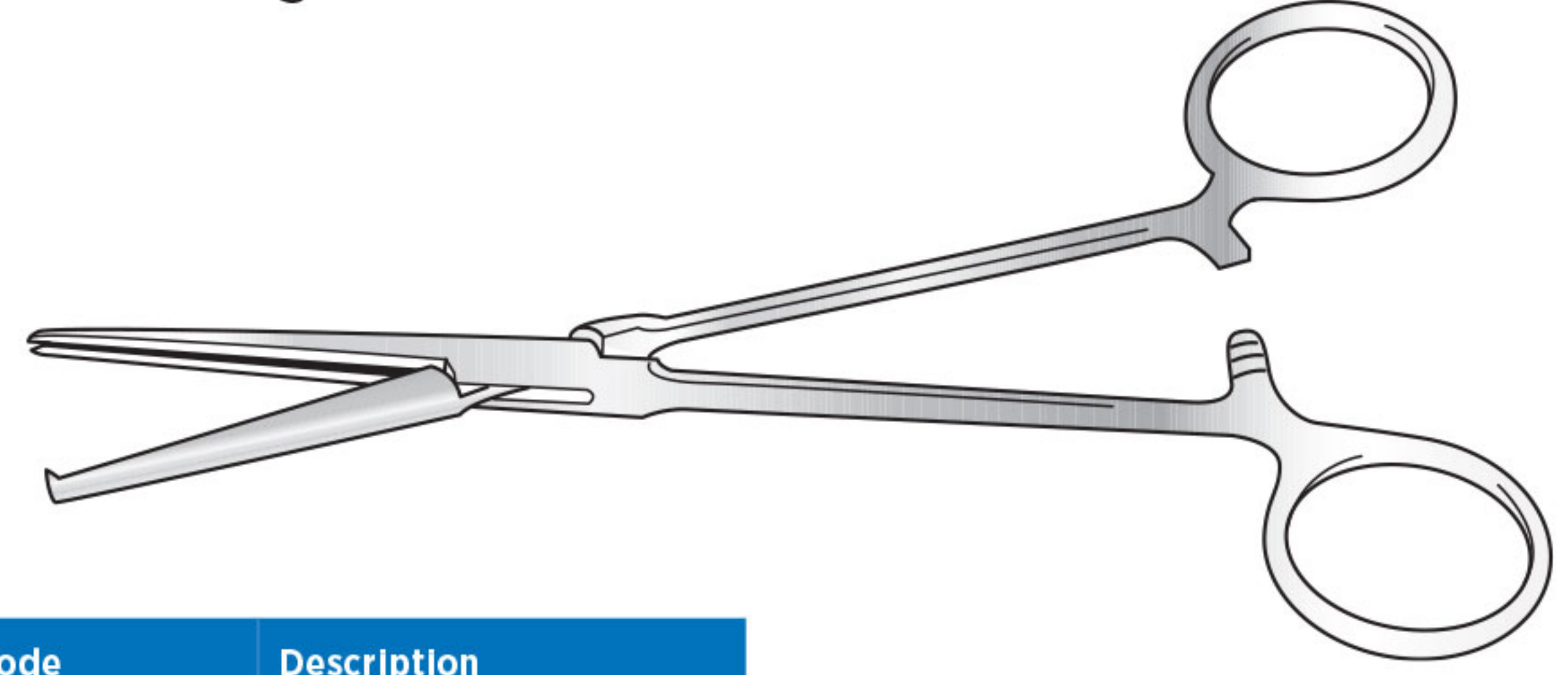

Code	Description
FST-3-155	Curved on flat, 1 - 2 teeth
FST-3-156	Straight

### Berkeley-Bonney Hysterectomy Forceps

Curved on flat, 1 - 2 teeth

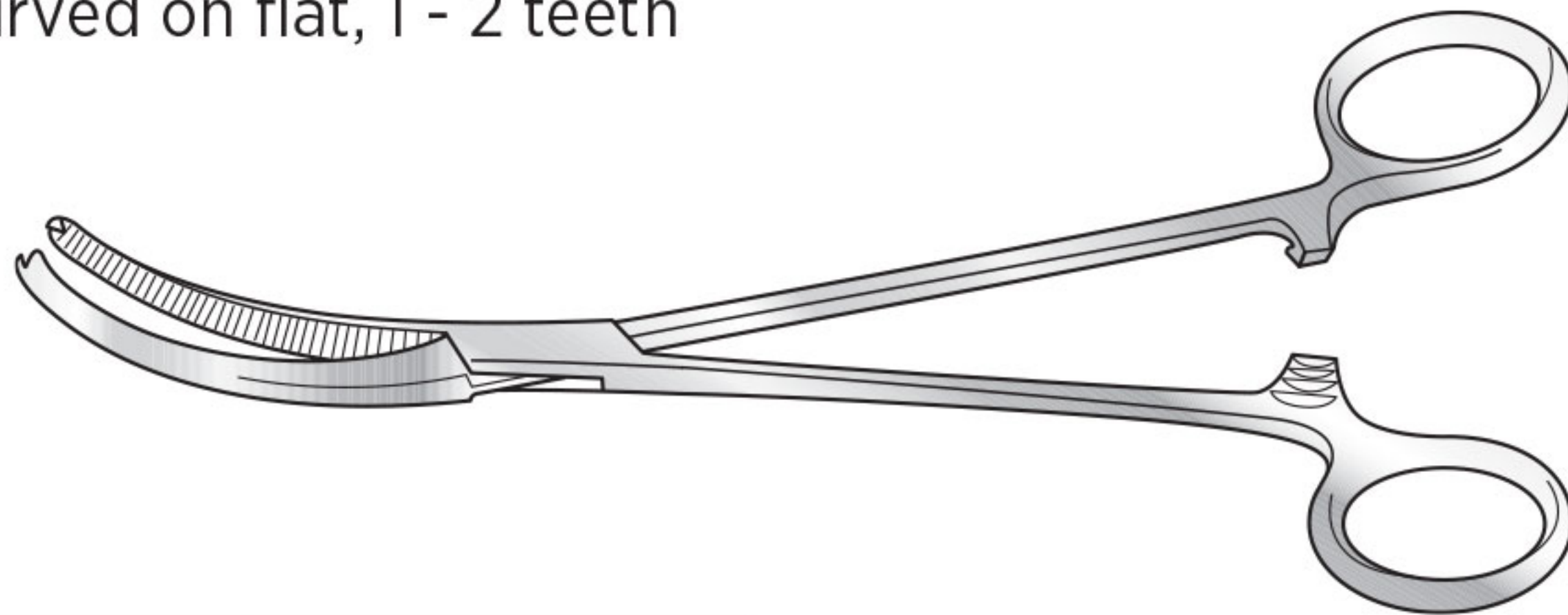

Code	Description
FST-3-161	203mm long

### Faures Peritoneum Forceps

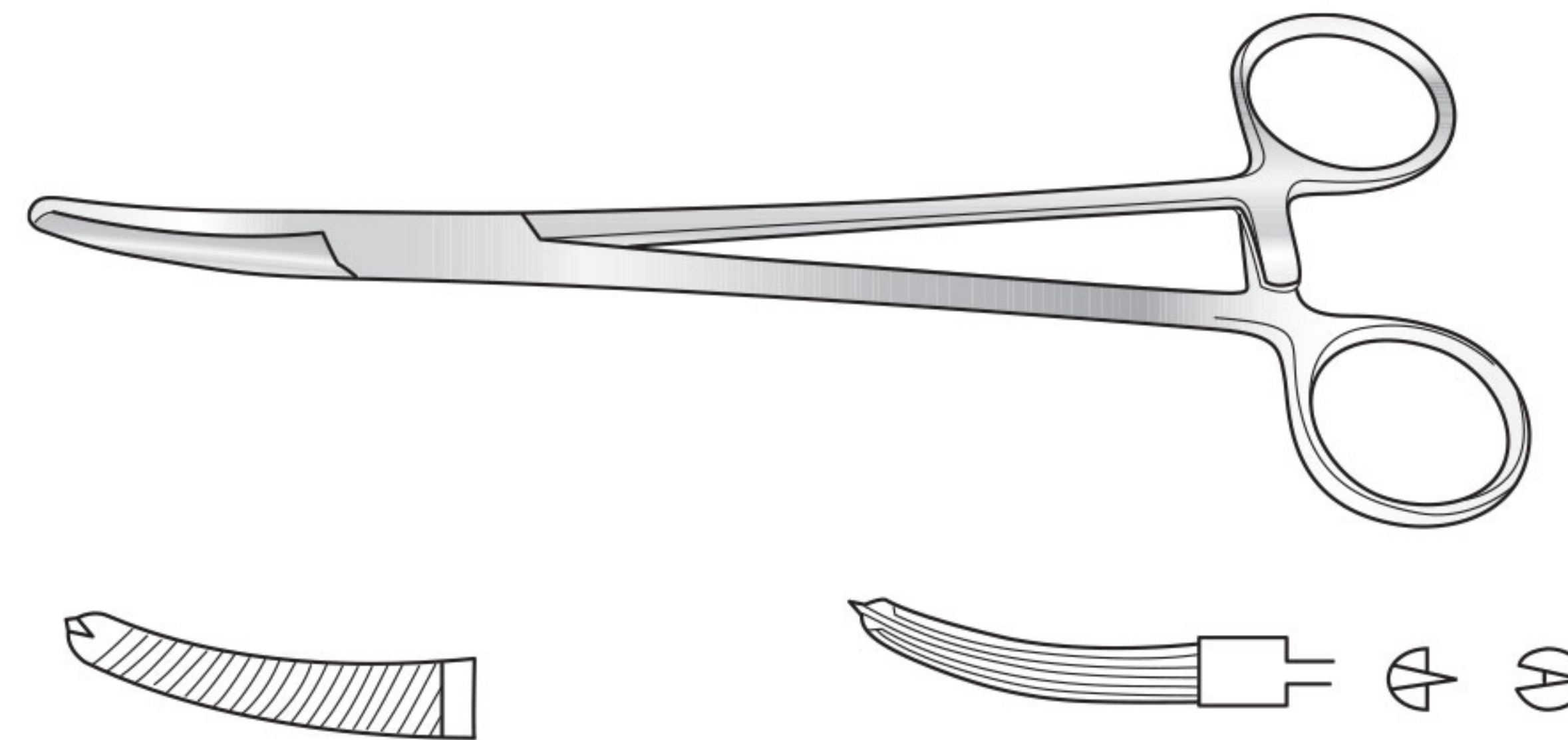

205mm long

Code	Description
FST-3-165	Slight curve

203mm long,  
longitudinal serrations

Code	Description
FST-3-166	Curved, toothed
FST-3-167	Curved

### Gwilliam Hysterectomy Forceps

Longitudinal serrations  
203mm long

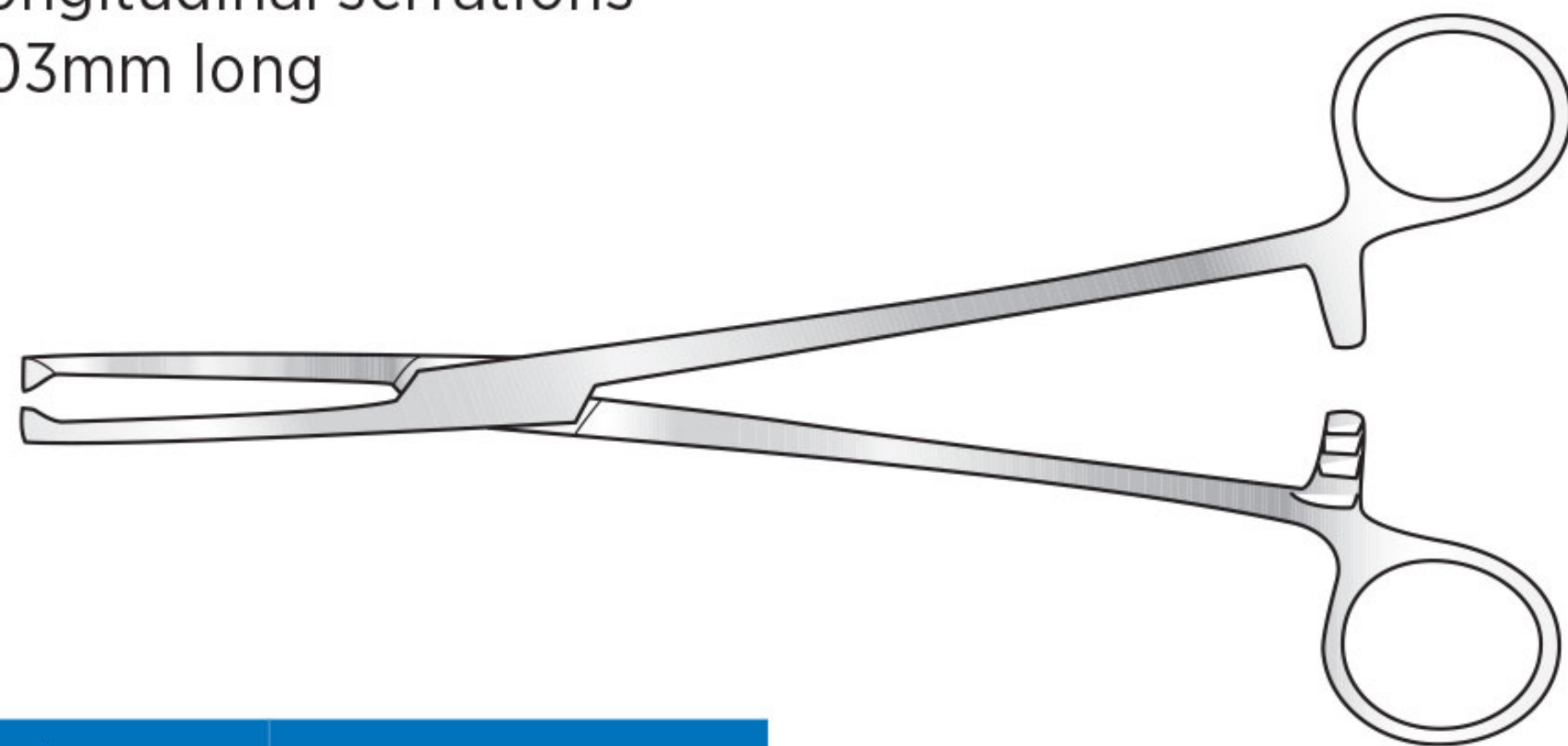

Code	Description
FST-3-170	Straight,
FST-3-171	Curved on flat, 1-2 teeth

### Heaney Hysterectomy Forceps

Curved on flat, 203mm long

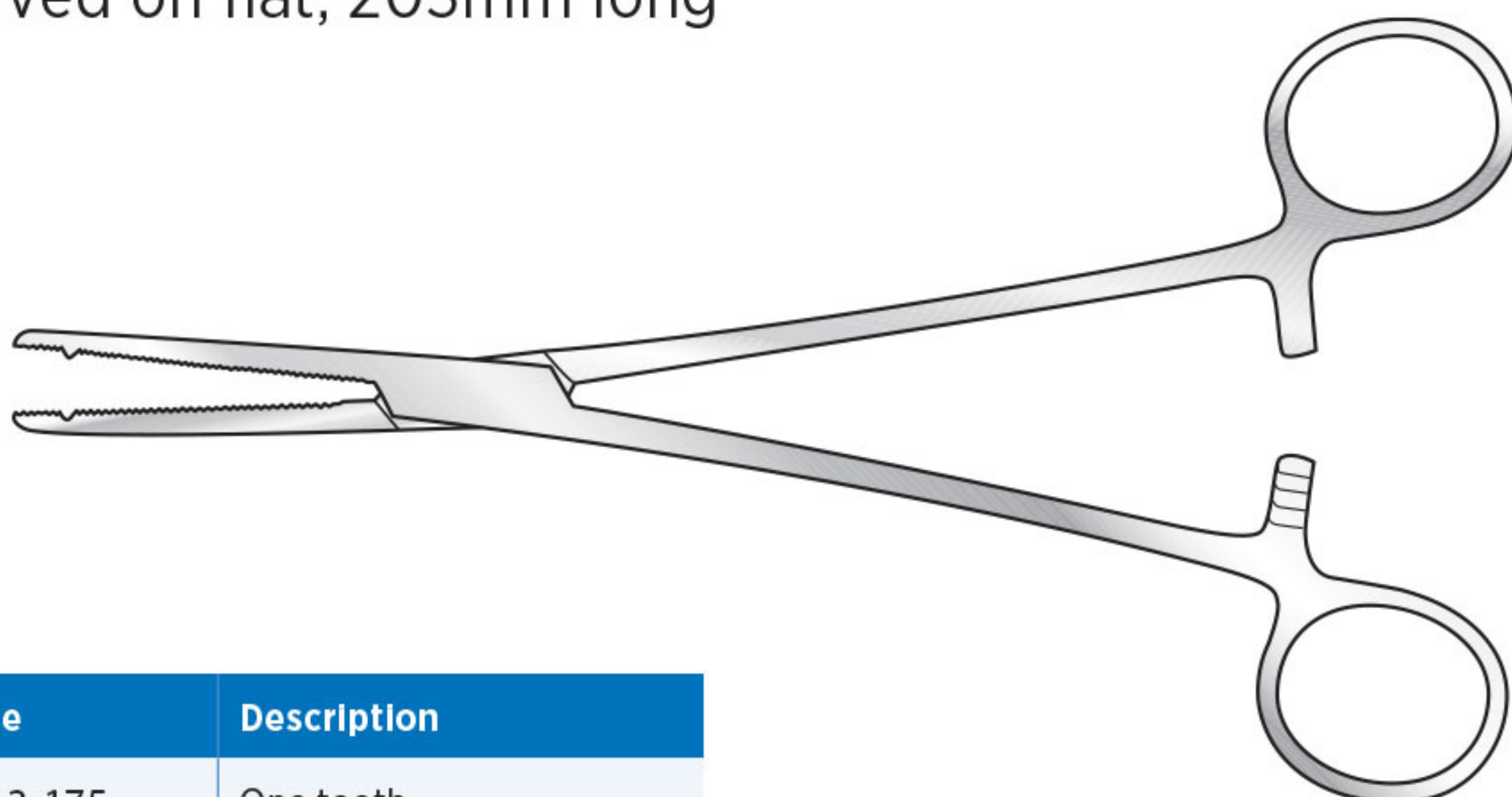

Code	Description
FST-3-175	One tooth
FST-3-176	Double tooth



# Forceps

## Bonney Uterine Polypus Forcep

Box joint

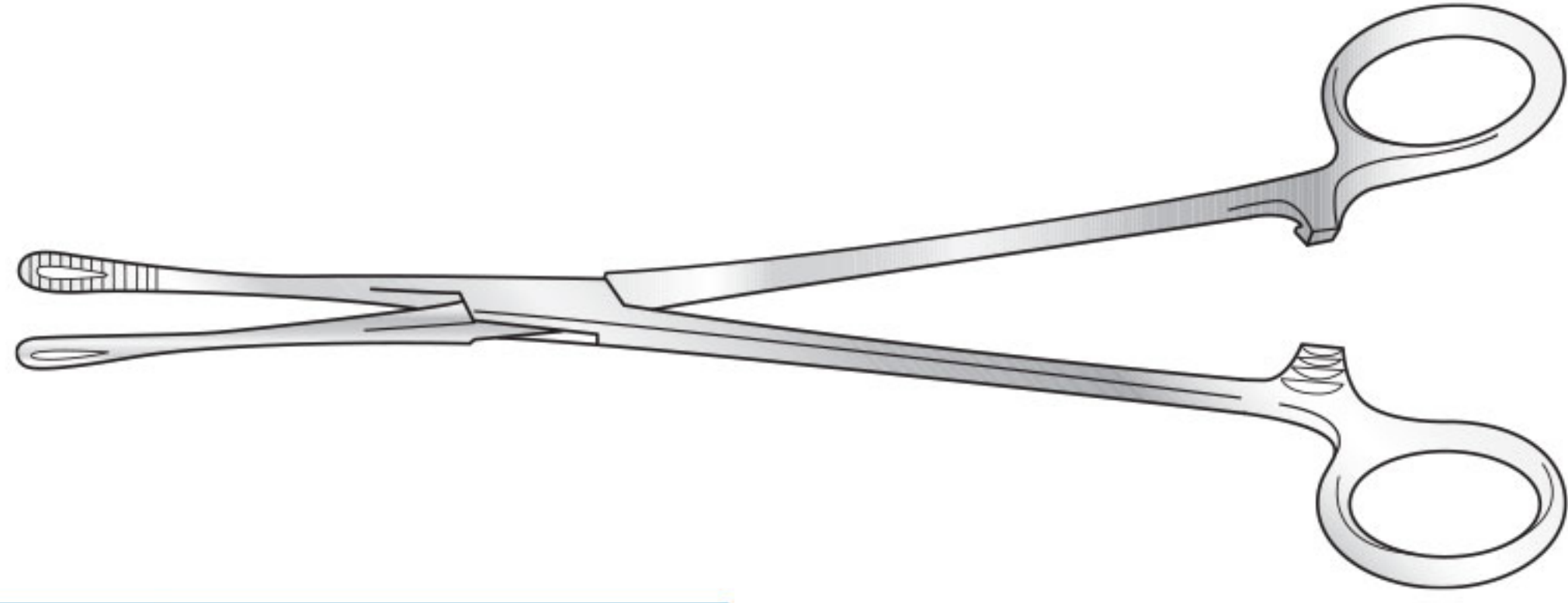

Code	Description
FST-3-180	240mm long

## Somer Uterus Holding Forcep

Matt finish

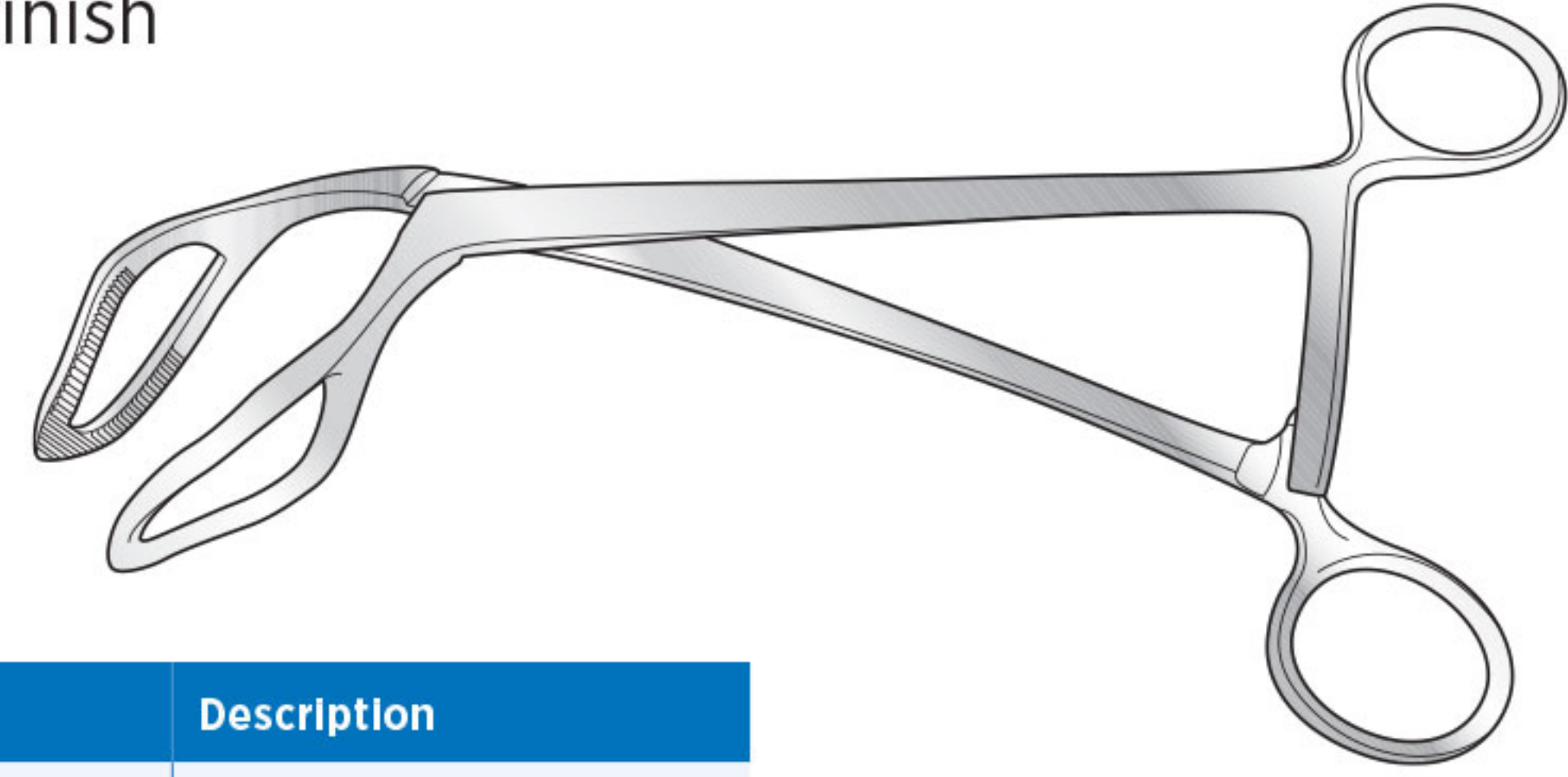

Code	Description
FST-3-184	230mm long
FST-3-185	254mm long

## Noto Uterine Polypus Forceps

Matt finish

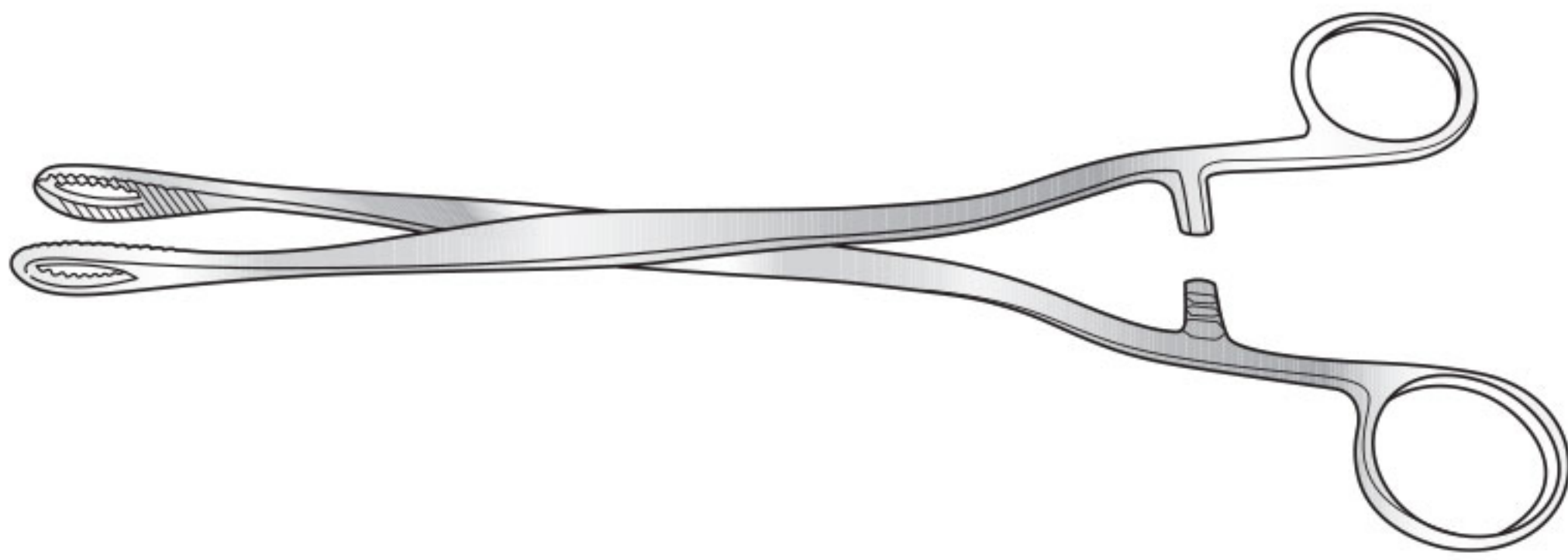

Code	Description
FST-3-190	240mm long

## McClintock Ovum Forcep

Curved, screw joint

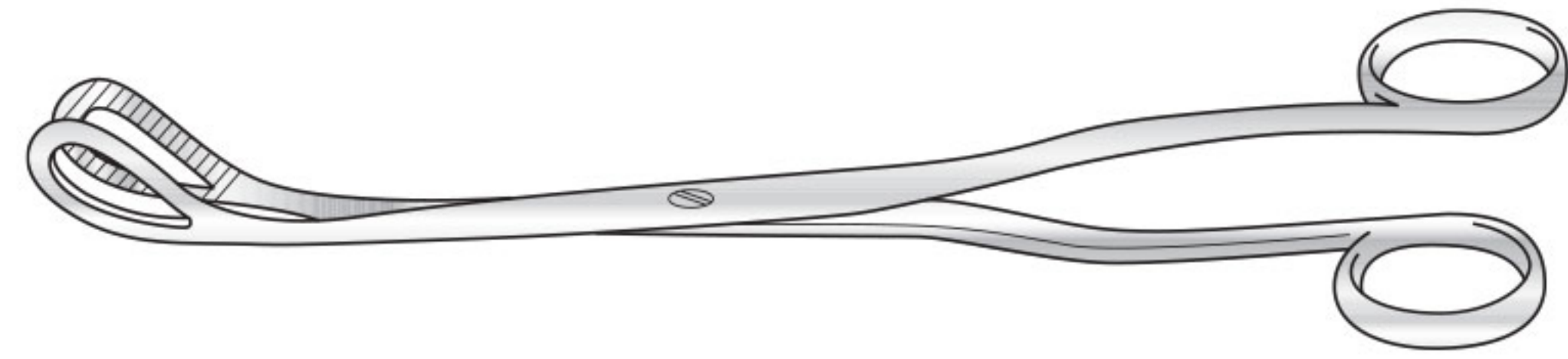

Code	Description
FST-3-195	241mm long

## Vant Uterine Polypus Forcep

Serrated

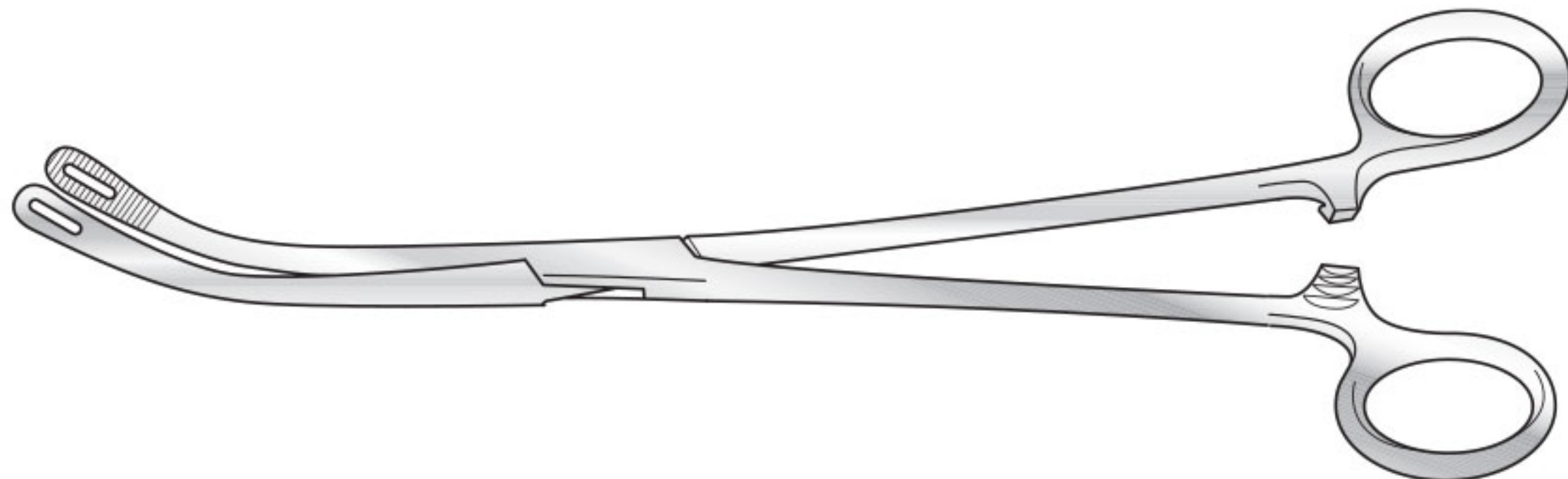

Code	Description
FST-3-200	240mm long

## Greenhalgh Ovum Forcep

Screw joint

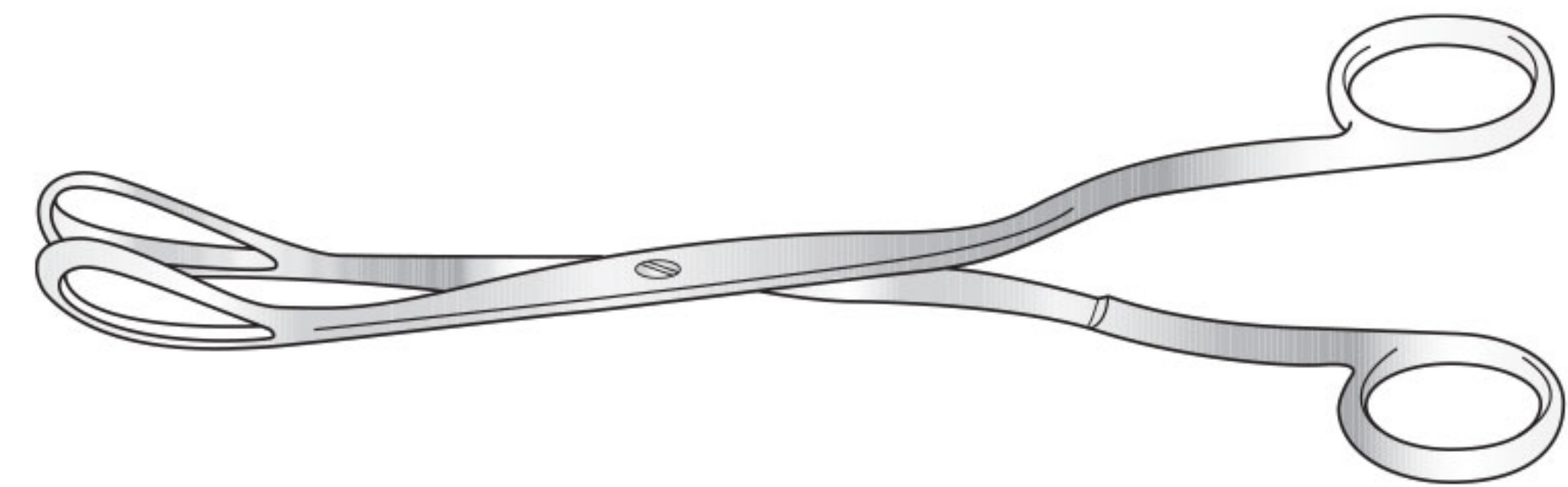

Code	Description
FST-3-201	240mm long

## Dartigues Uterine Forceps

Matt finish

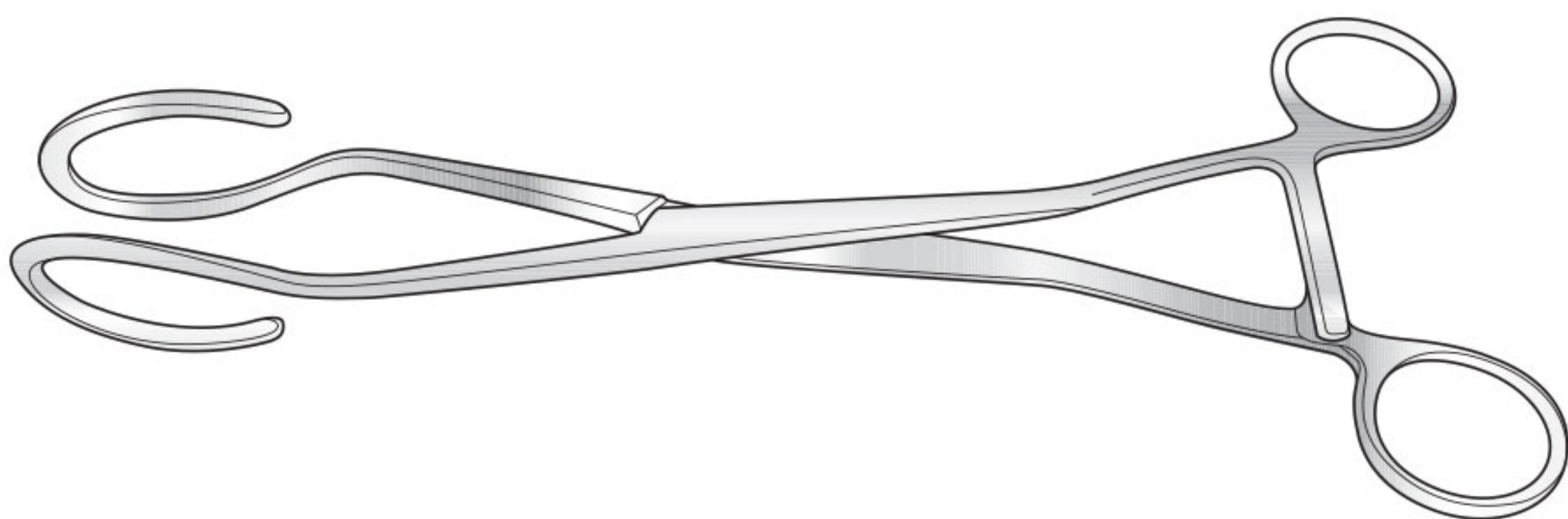

Code	Description
FST-3-202	270mm long

## Keily Ovum Forceps

Matt finish

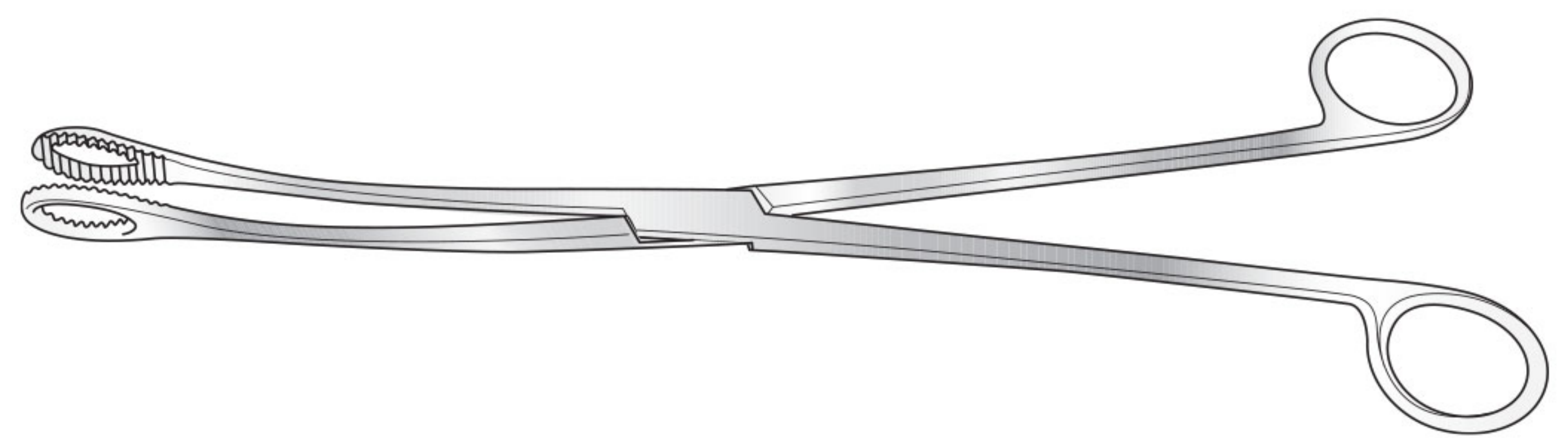

Code	Description
FST-3-203	320mm long



### Doyen Ovarian Forceps

Matt finish

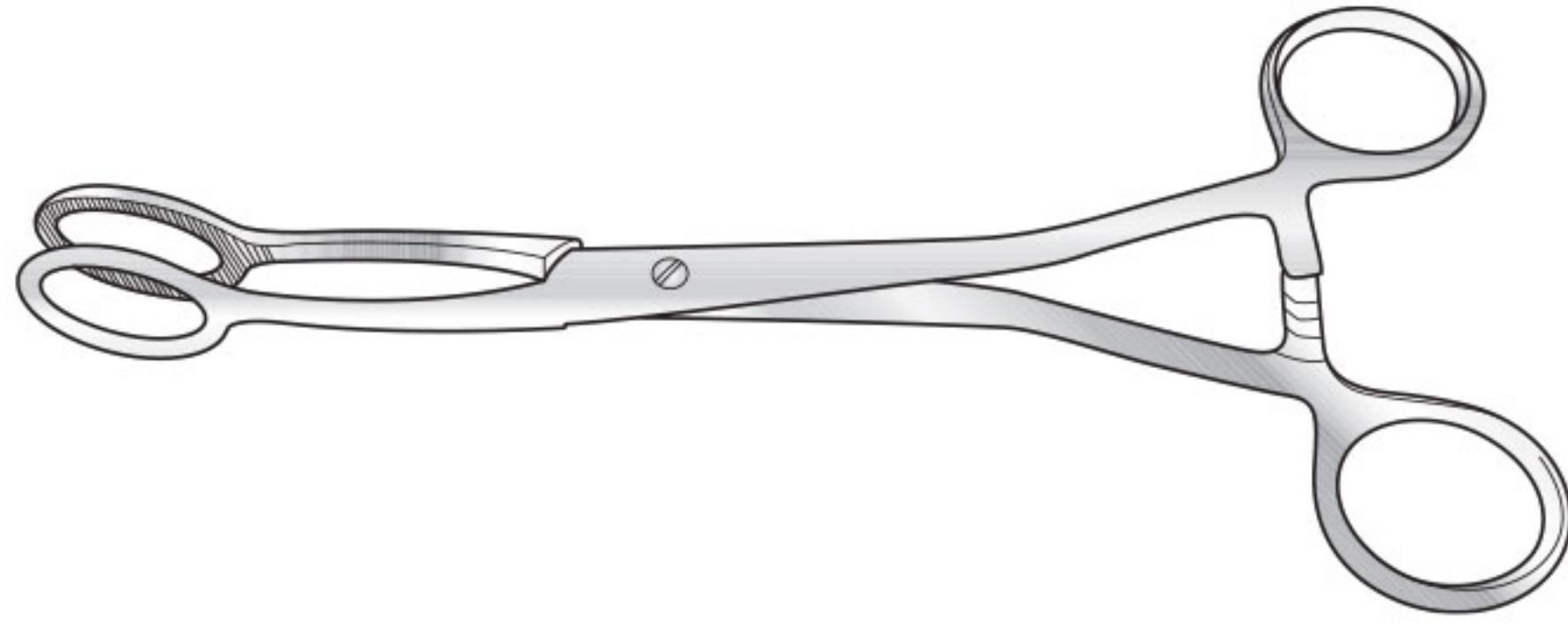

Code	Description
FST-3-210	210mm long

### Lowa Tenaculum Forceps

Matt finish, 5-6 teeth

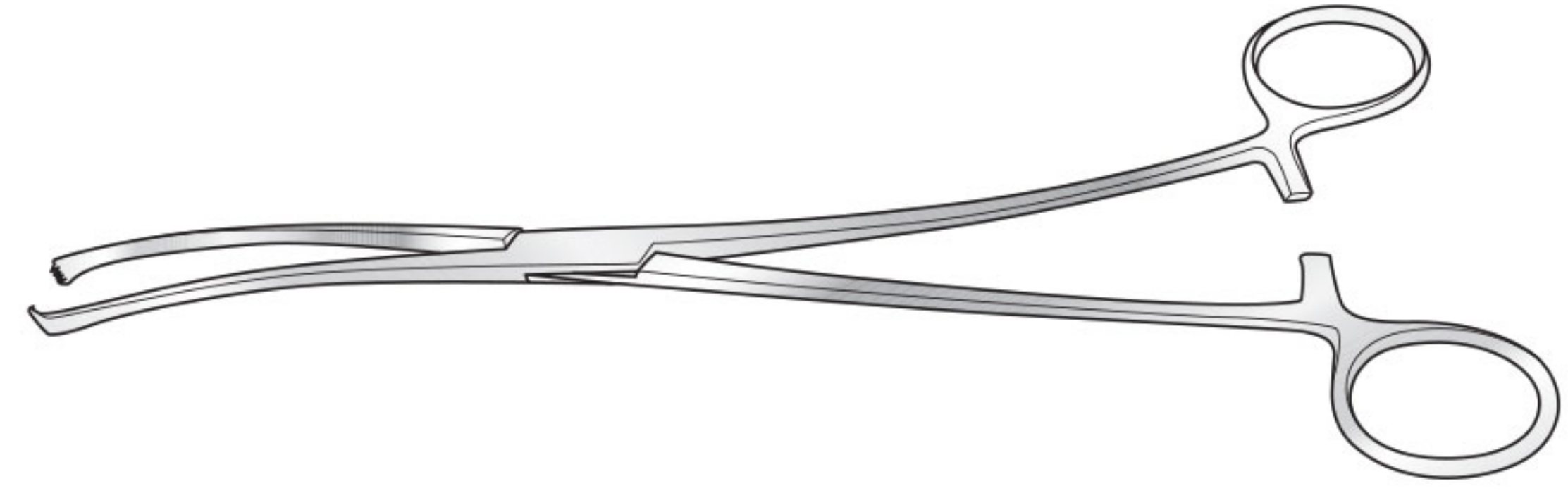

Code	Description
FST-3-211	260mm long

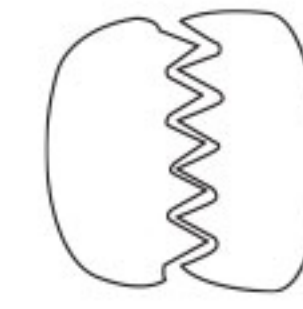

### Wertheim Parametrium Forcep

Curved on flat, screw joint

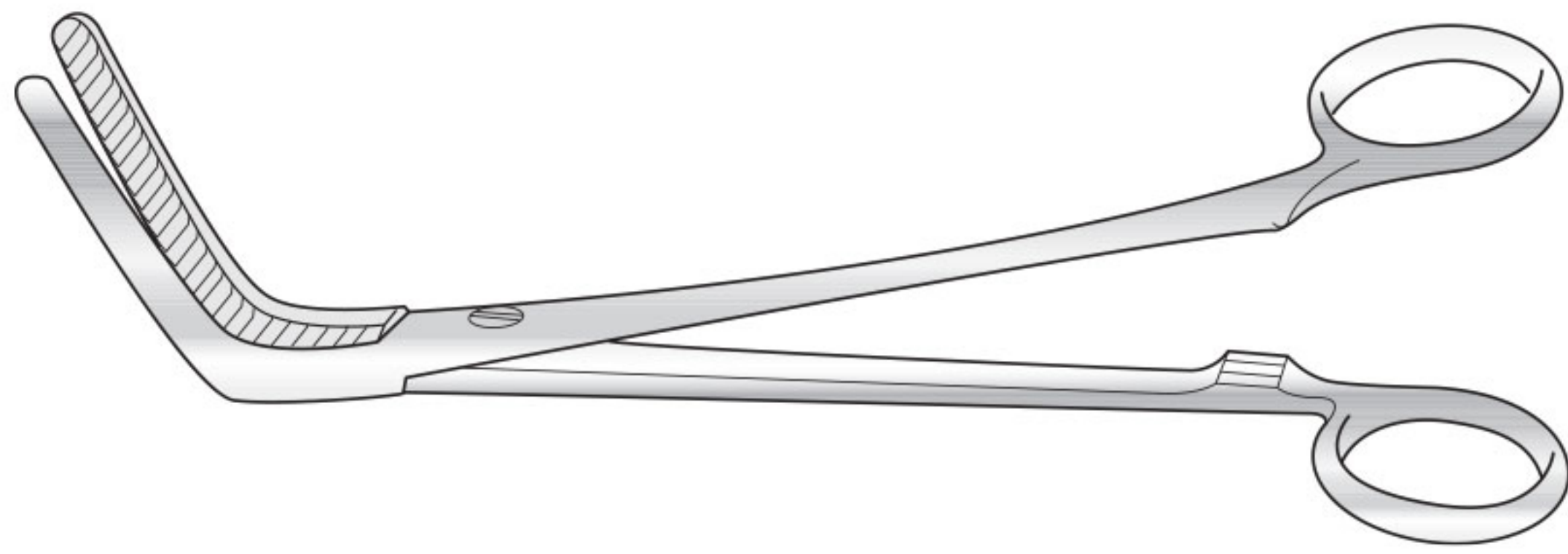

Code	Description
FST-3-212	254mm long

### Skene Tenaculum Forceps

Bright finish

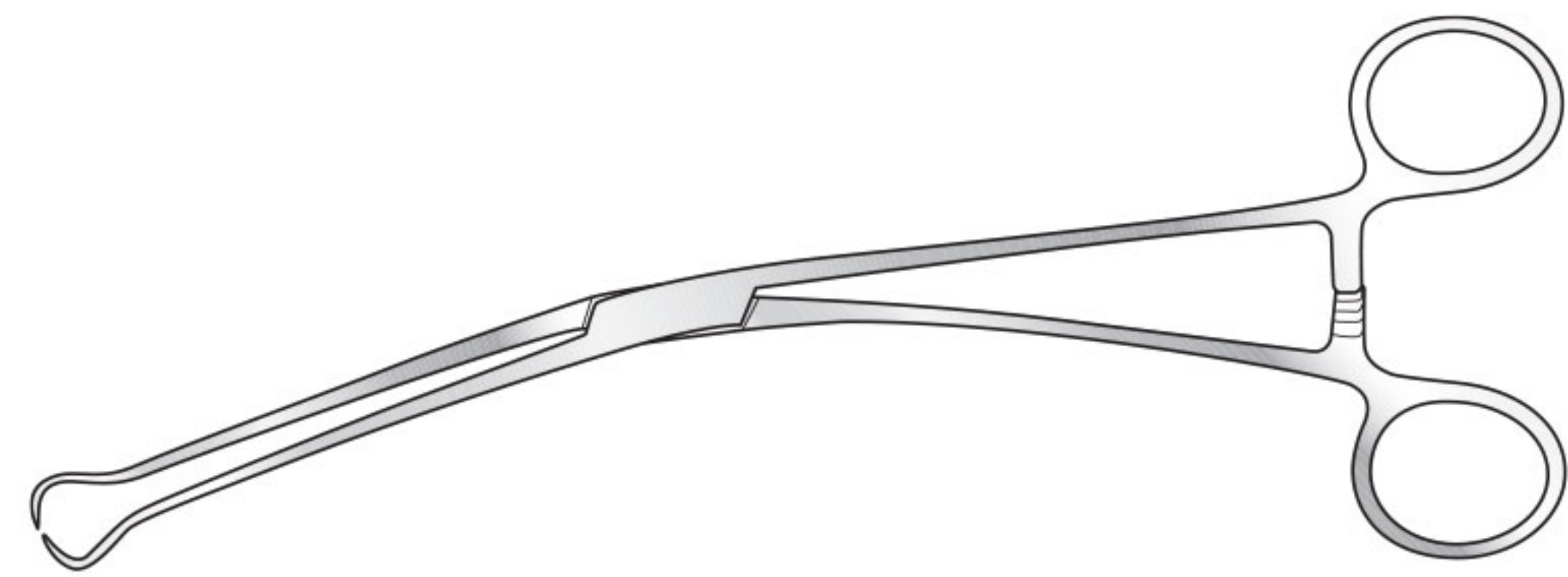

Code	Description
FST-3-213	240mm long

### Green-Armytage Haemostasis Forcep

Screw joint, 15mm jaw, 210mm long

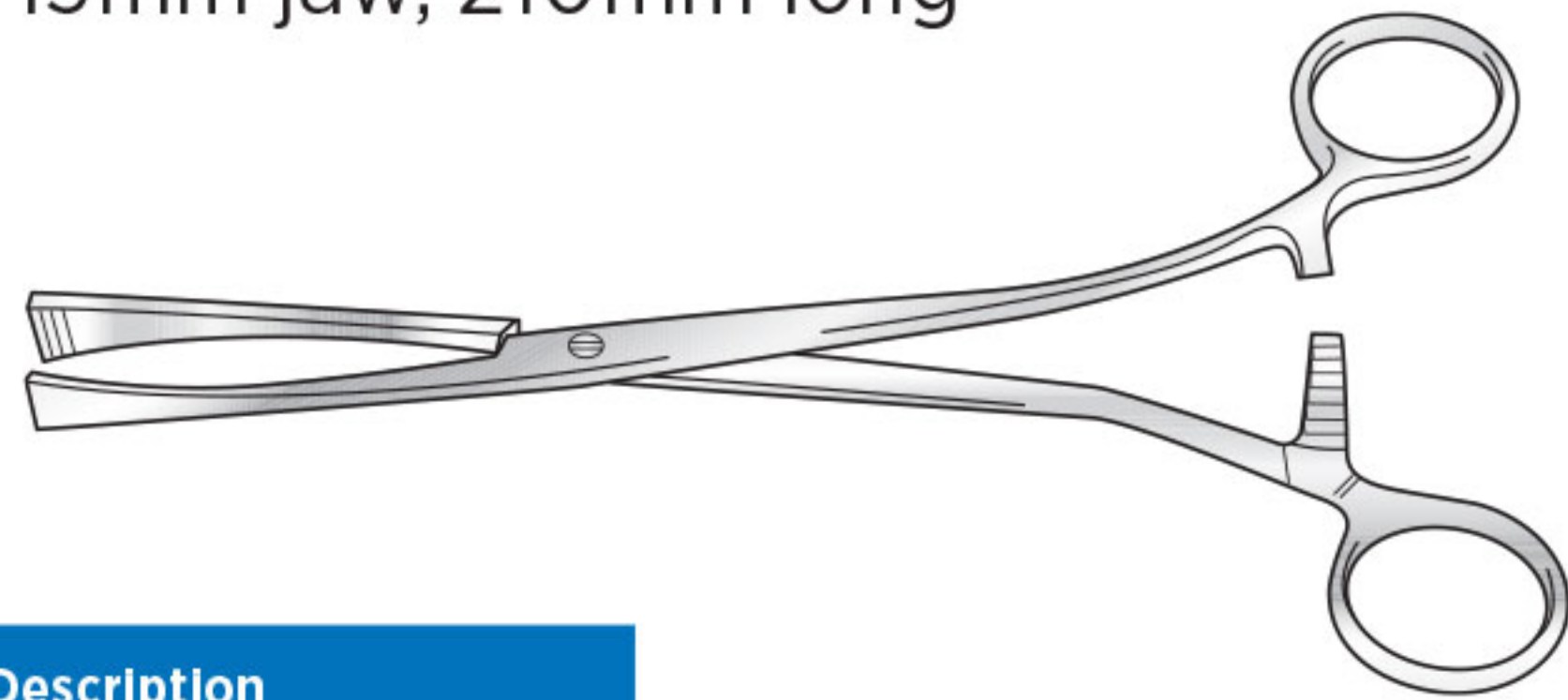

Code	Description
FST-3-214	Straight
FST-3-215	Angled

### Pratt Tenaculum Forceps

Matt finish

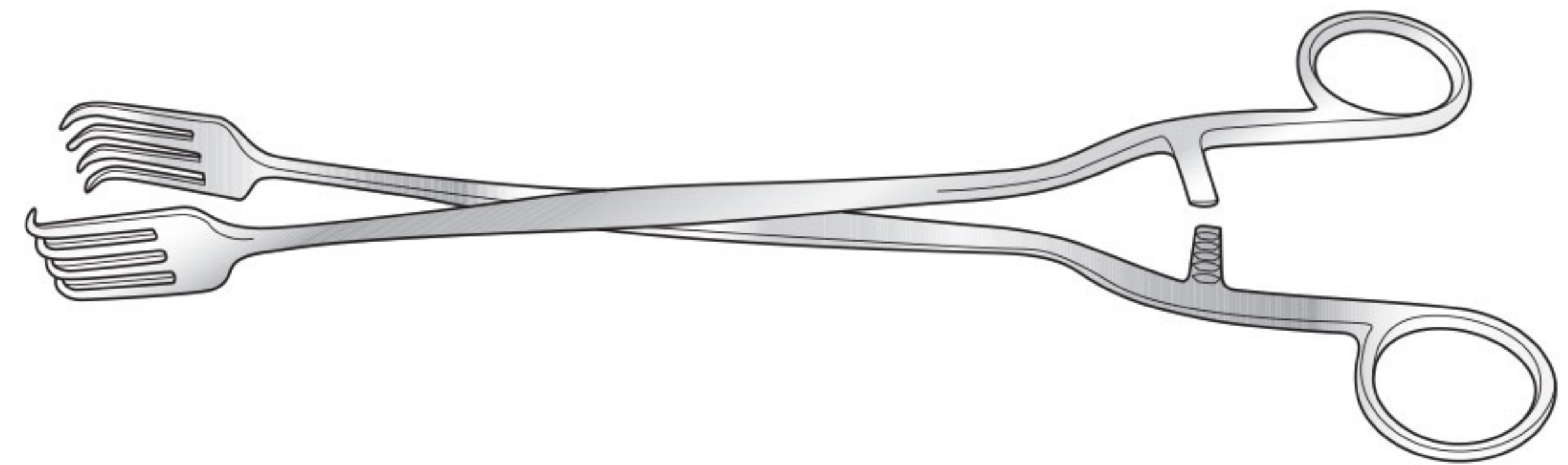

Code	Description
FST-3-216	280mm long

### Kogan Endocervical Forceps

Matt finish, 275mm long

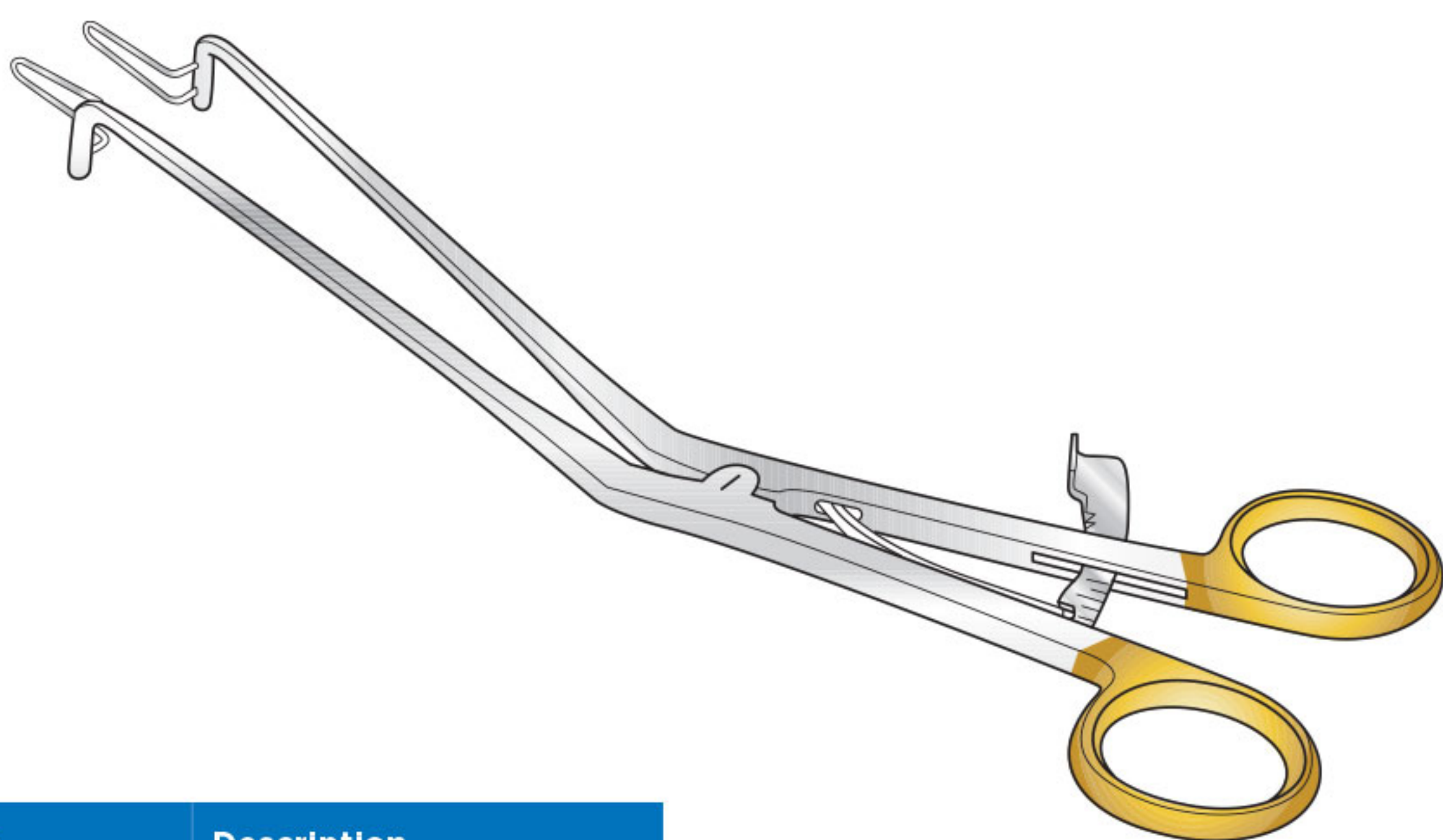

Code	Description
FST-3-217	3mm jaw
FST-3-218	5mm jaw
FST-3-219	7mm jaw

### Coil Removing Forcep

With serrated rounded jaws  
4mm wide

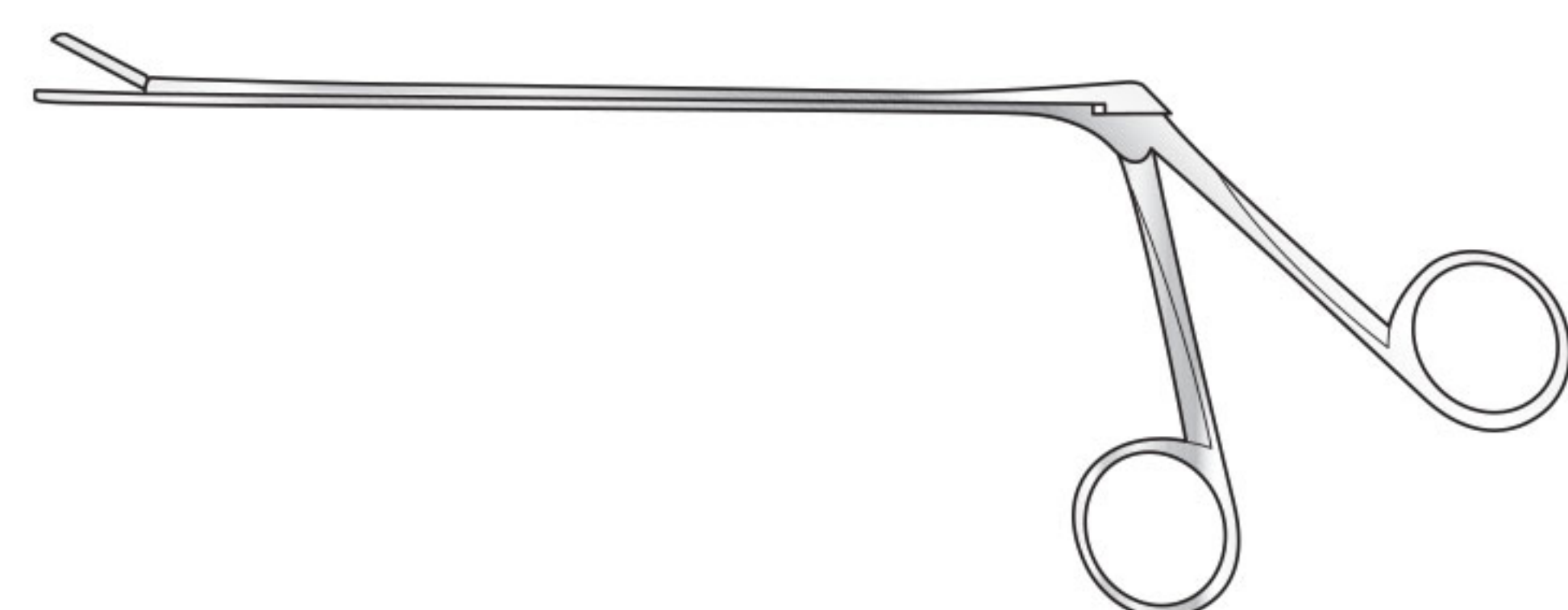

Code	Description
FST-3-220	160mm to shoulder



# Forceps and Biopsy Forceps

## Willet Martel Forceps

Matt finish

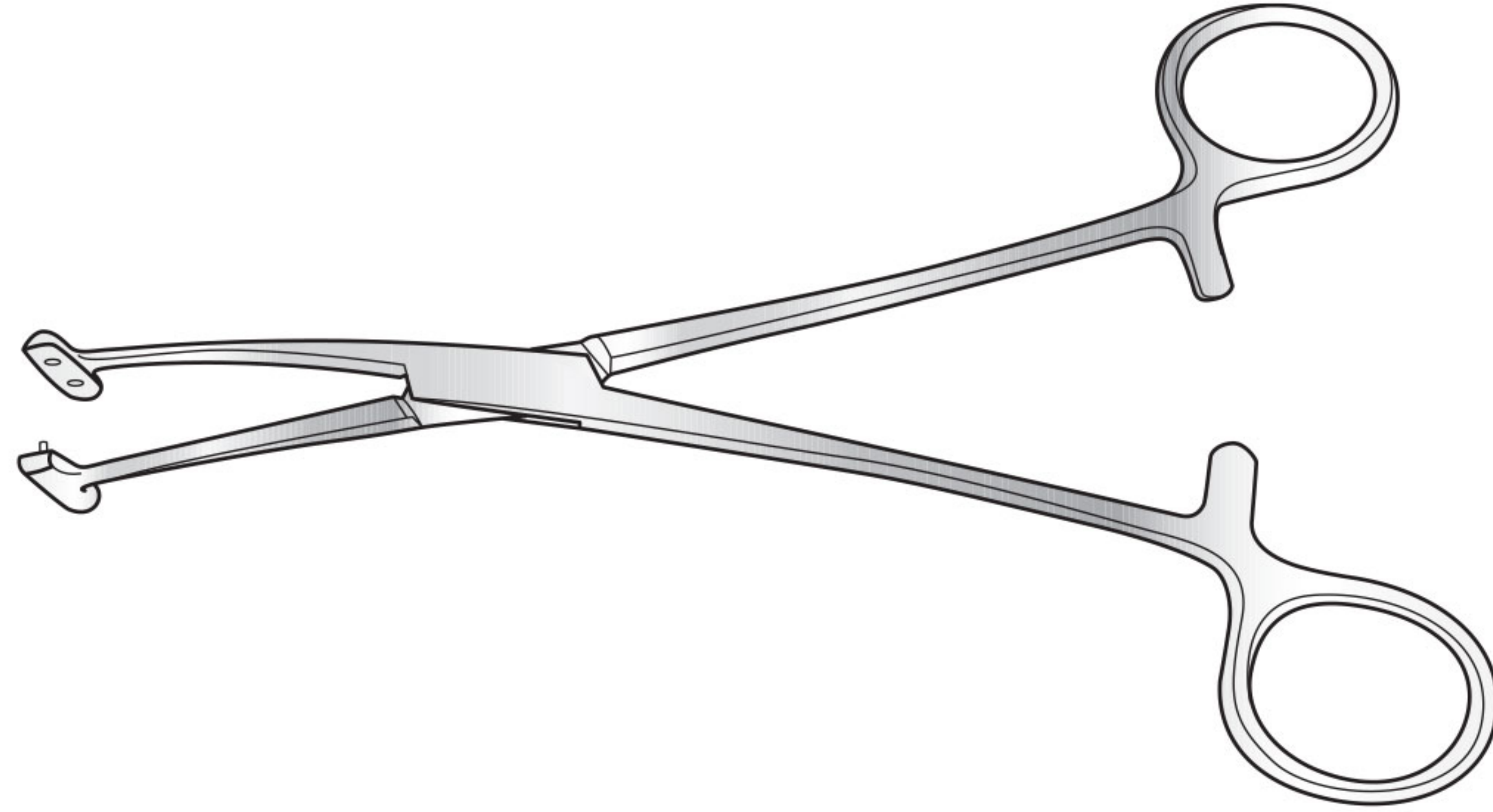

Code	Description
FST-3-230	190mm long

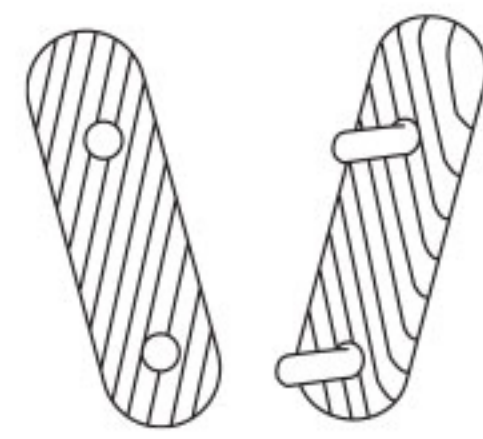

## Littlewood Tissue Forceps

2-3 teeth, matt finish

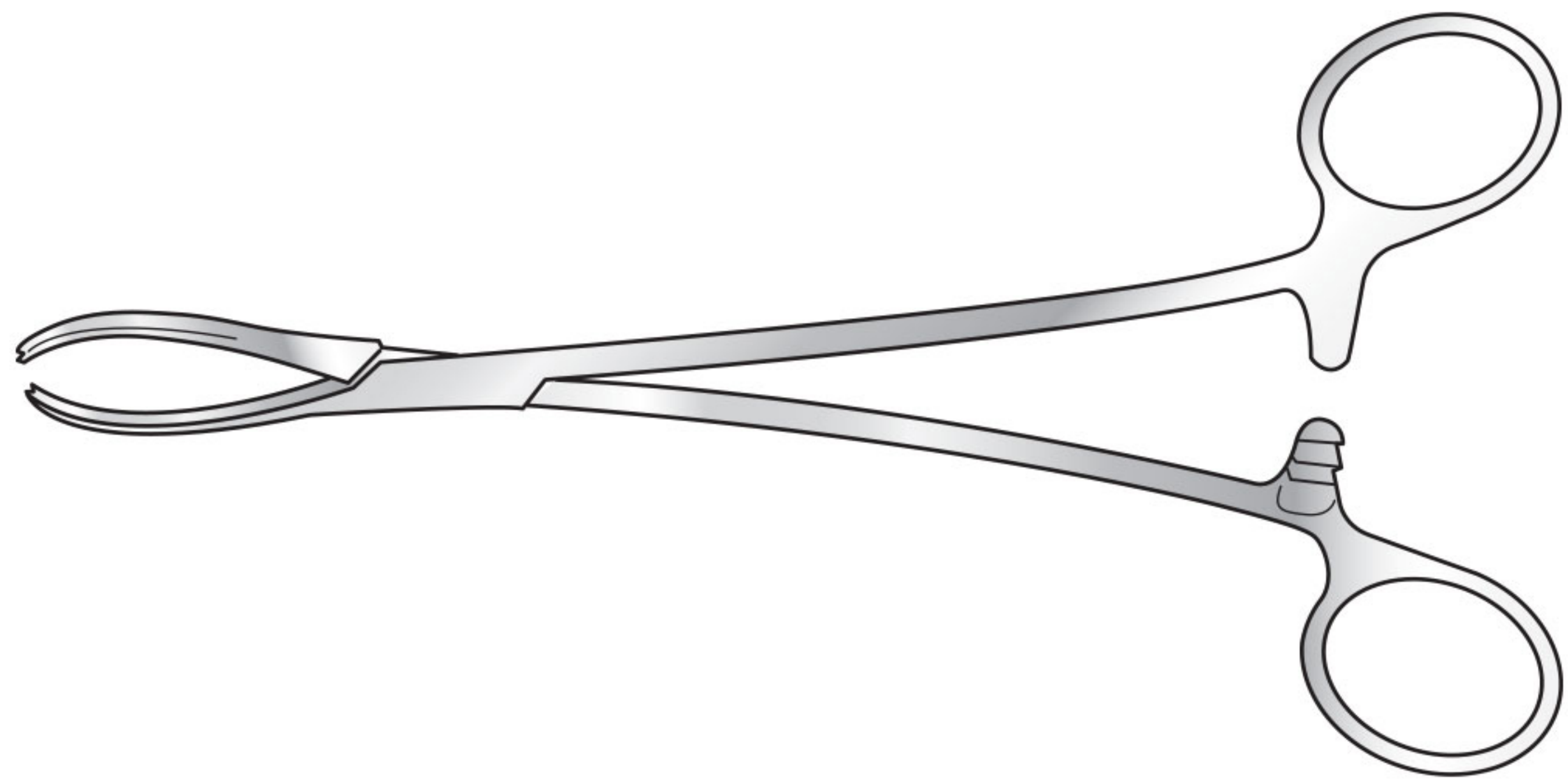

Code	Description
FST-3-231	190mm long

## Eppendorf Biopsy Punch Forcep

200mm to shoulder

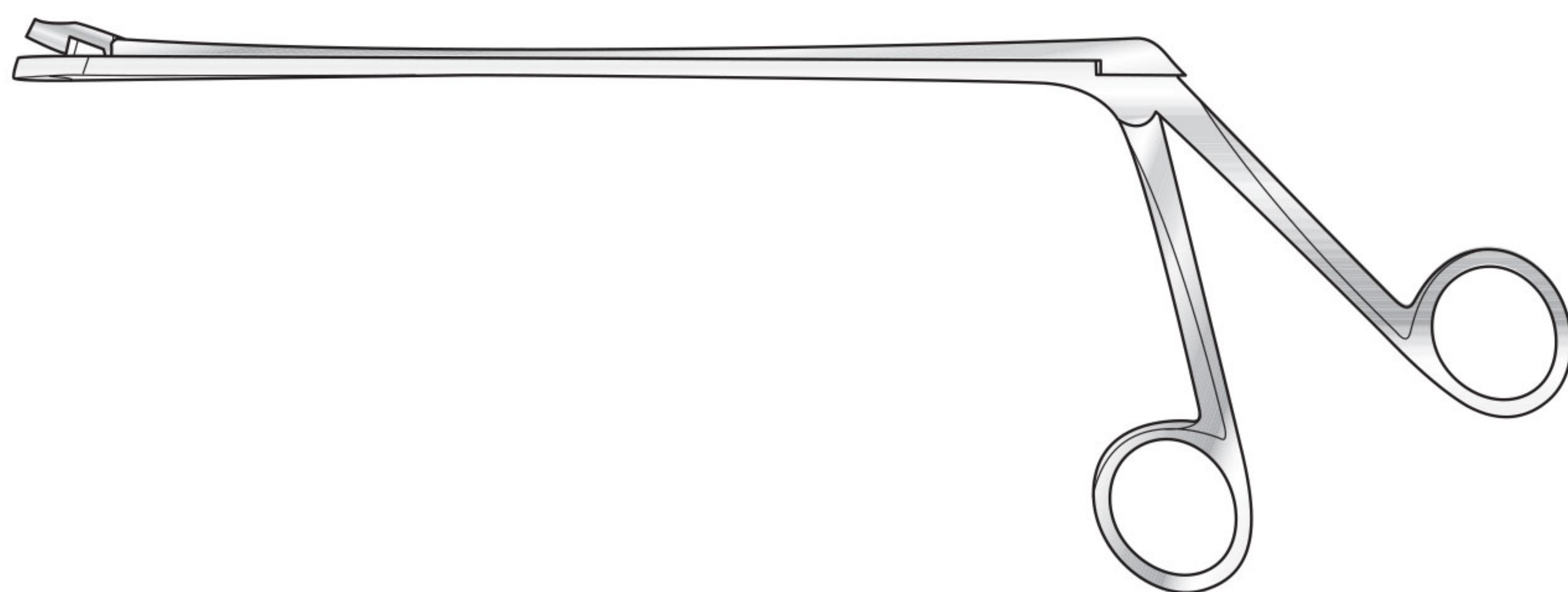

Bite shown actual size

Code	Description
FST-3-232	3mm x 8mm bite



## Kevorkian Biopsy Punch Forcep

255mm to shoulder

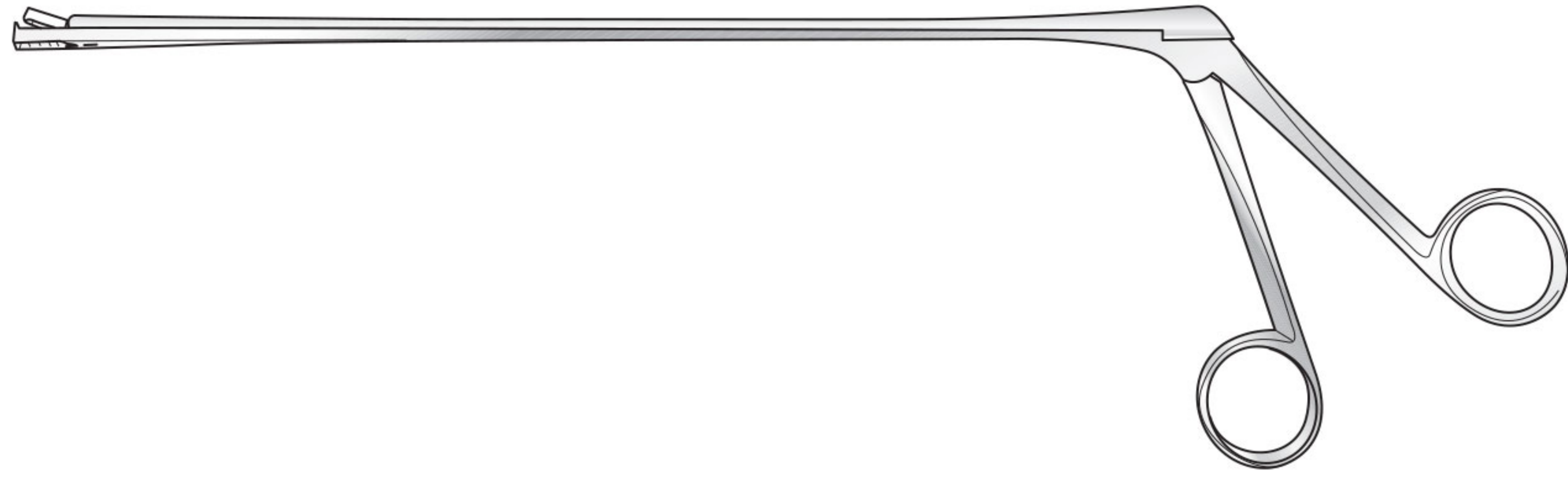



 Bite shown actual size

Code	Description
FST-3-240	3mm x 8mm bite

## Tischler Morgan Biopsy Forcep

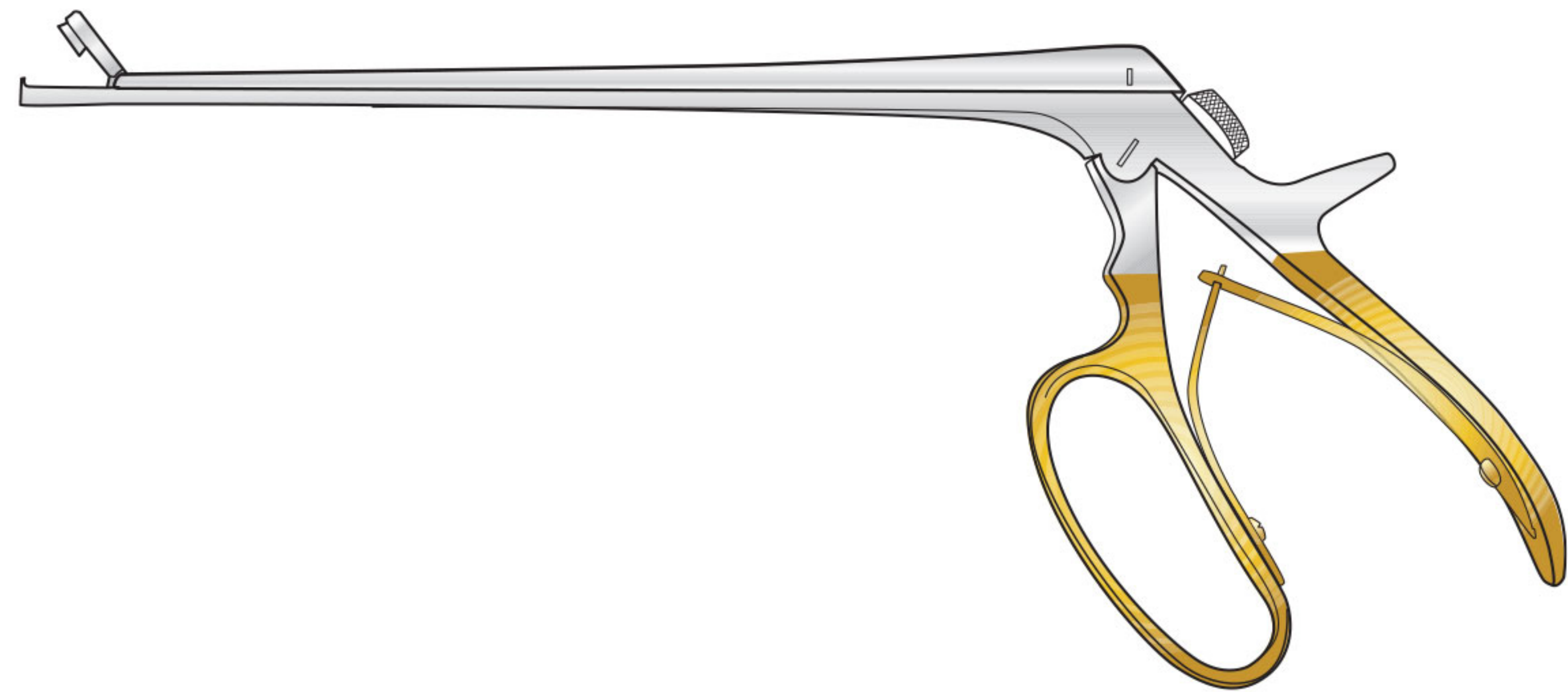
210mm to shoulder





 Bite shown actual size

Code	Description
FST-3-241	3mm x 7mm bite

## Tischler Morgan Biopsy Punch Forcep

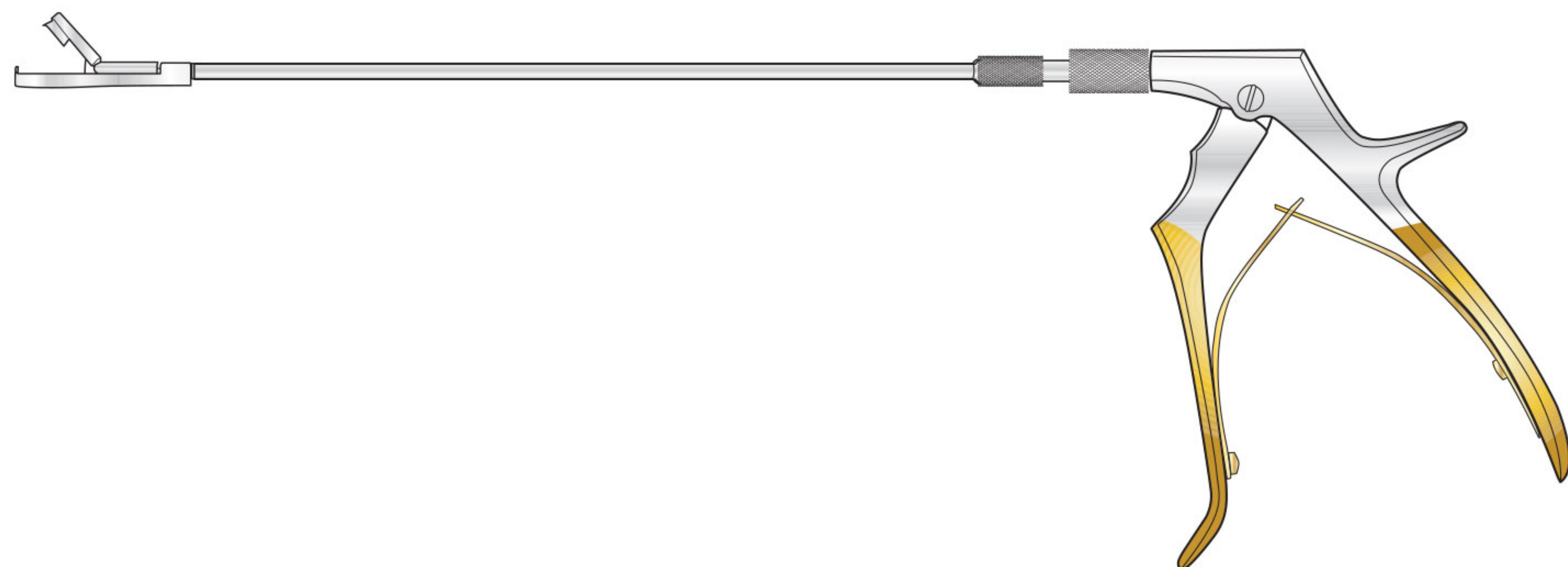
295mm to shoulder



 Bite shown actual size

Code	Description
FST-3-242	2mm x 7mm bite



# Biopsy Forceps

## Baby Tischler Biopsy Forcep

210mm to shoulder

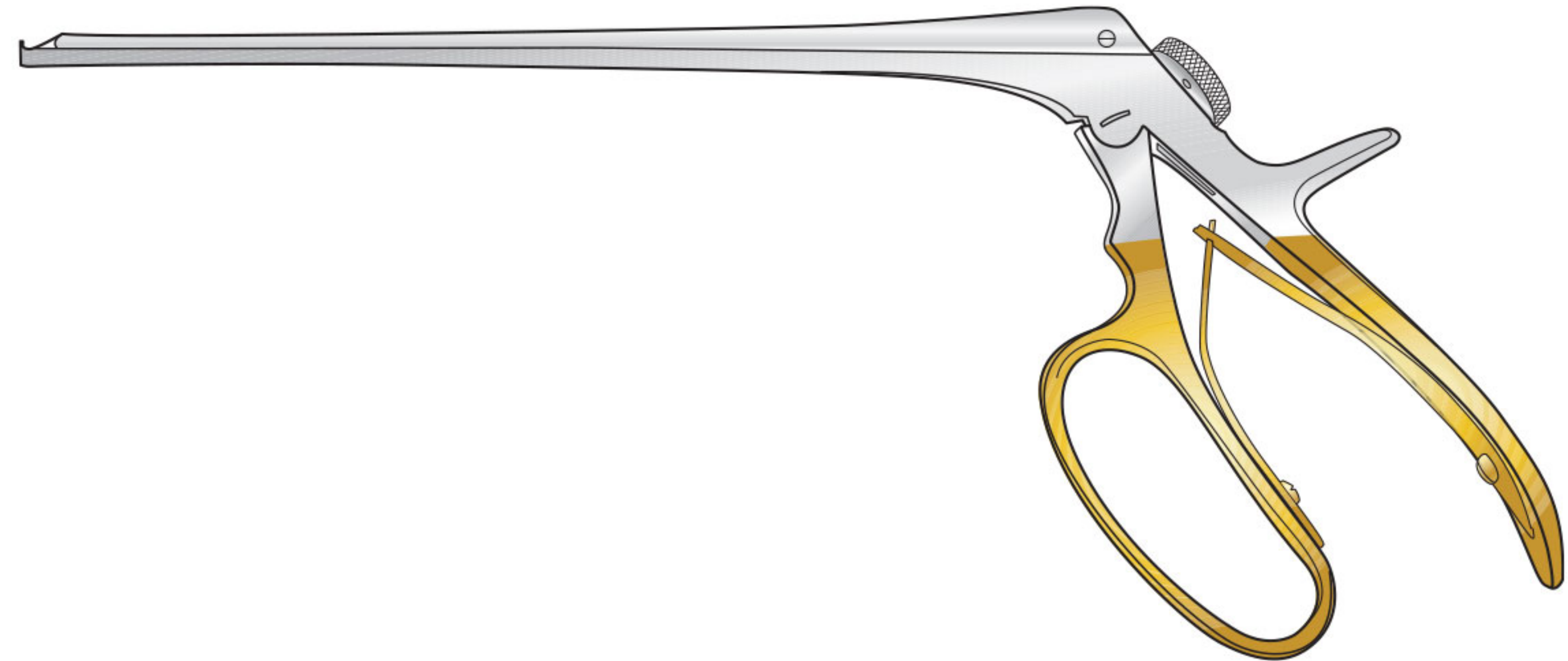

 Bite shown actual size

Code	Description
FST-3-250	2mm x 5mm bite

## Baby Tischler Biopsy Punch Forcep

295mm to shoulder

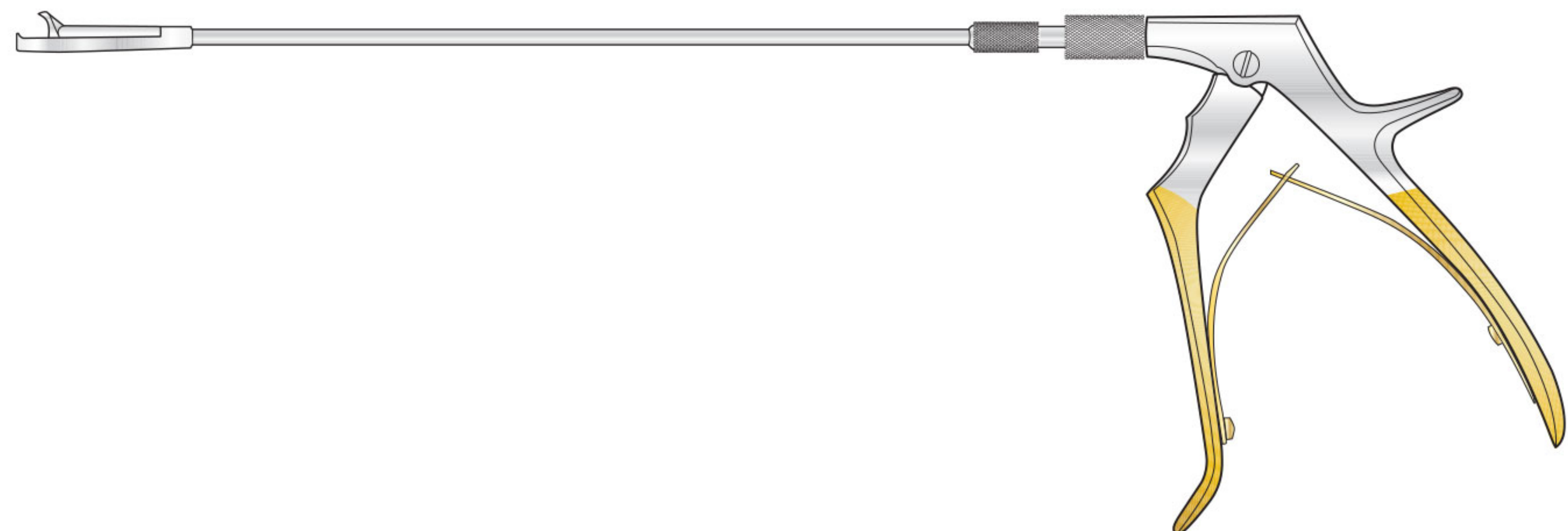



 Bite shown actual size

Code	Description
FST-3-251	2mm x 5mm bite

## Van Doren Biopsy Forceps

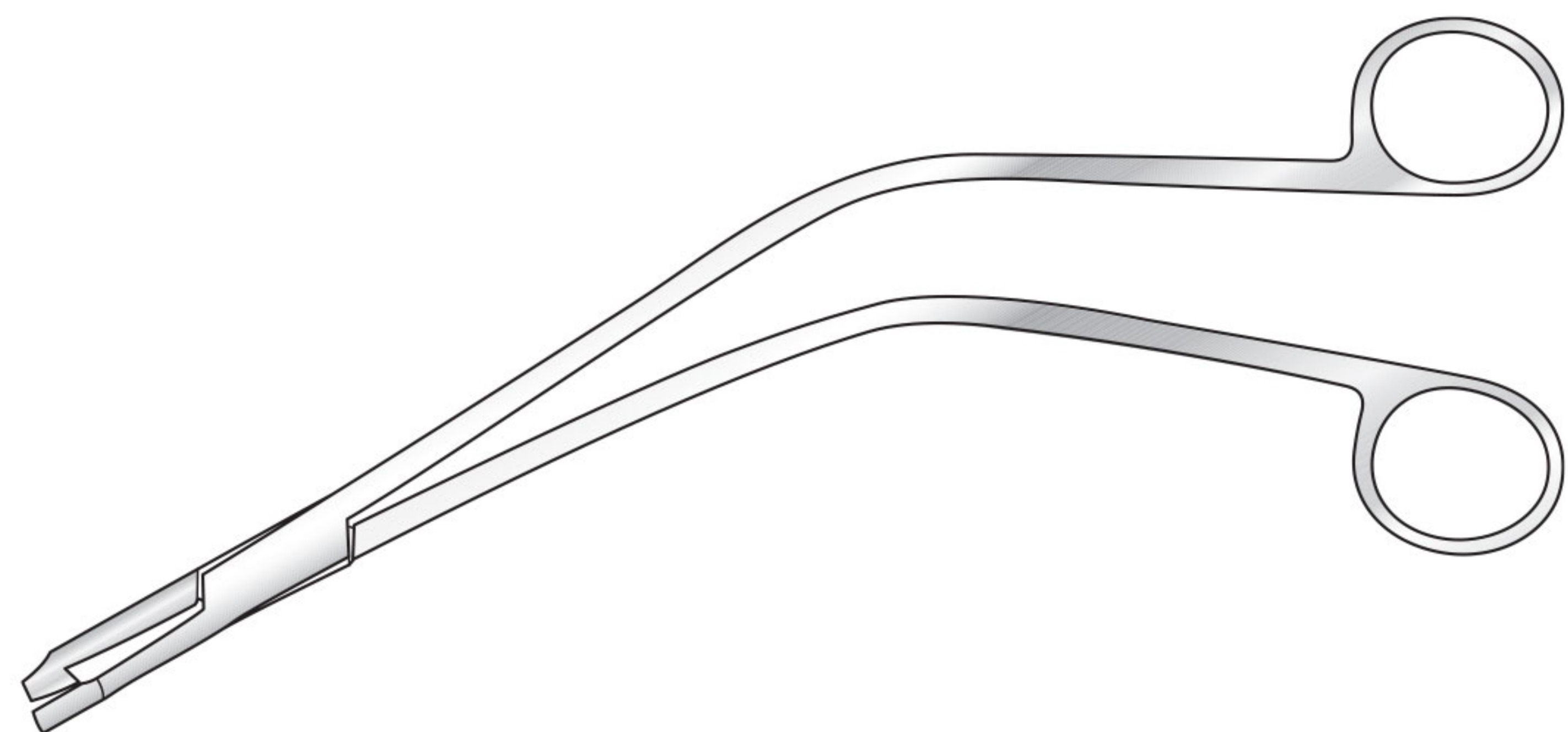
Bright finish, 260mm overall length



 Bite shown actual size

Code	Description
FST-3-252	5mm x 9mm bite

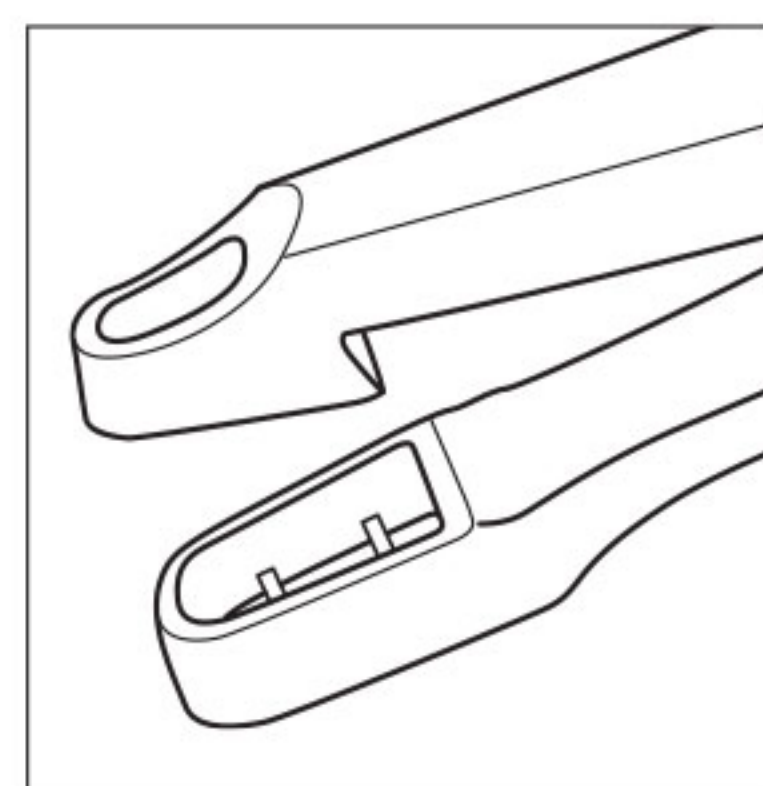



## Van Doren Cervical Biopsy Punch Forcep

With curved basket jaw, angled shanks

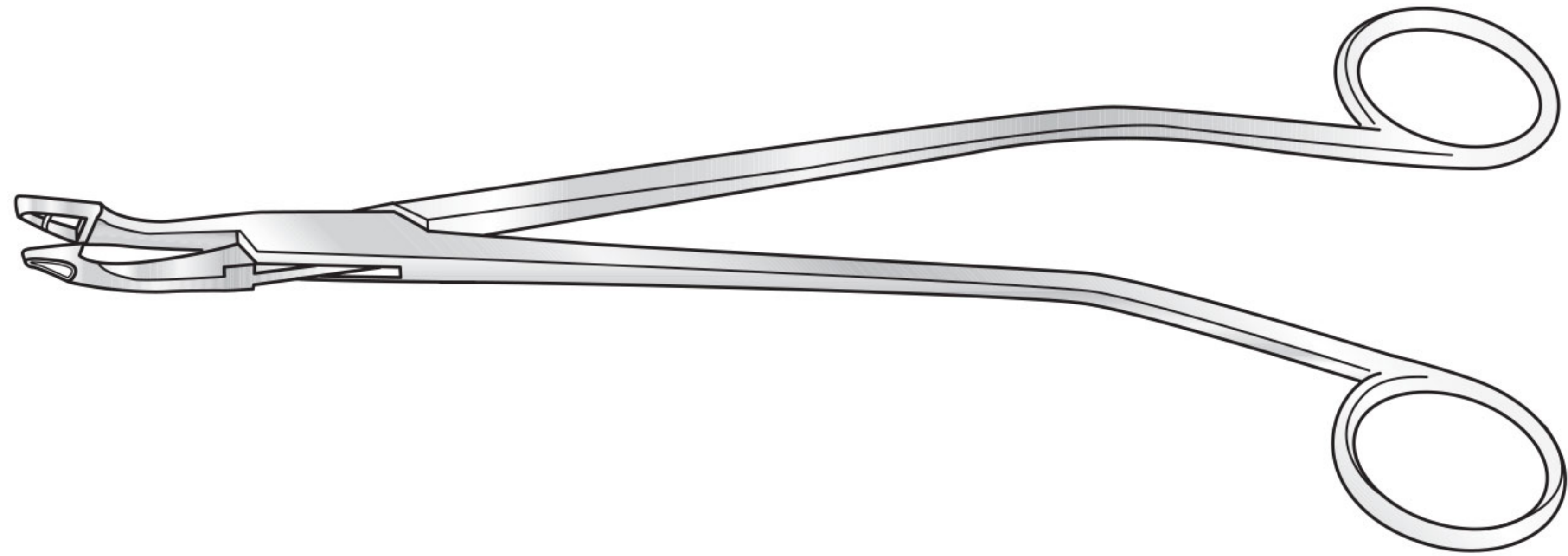

Code	Description
FST-3-260	240mm long

## Wittner Cervical Biopsy Punch Forcep

240mm long shaft

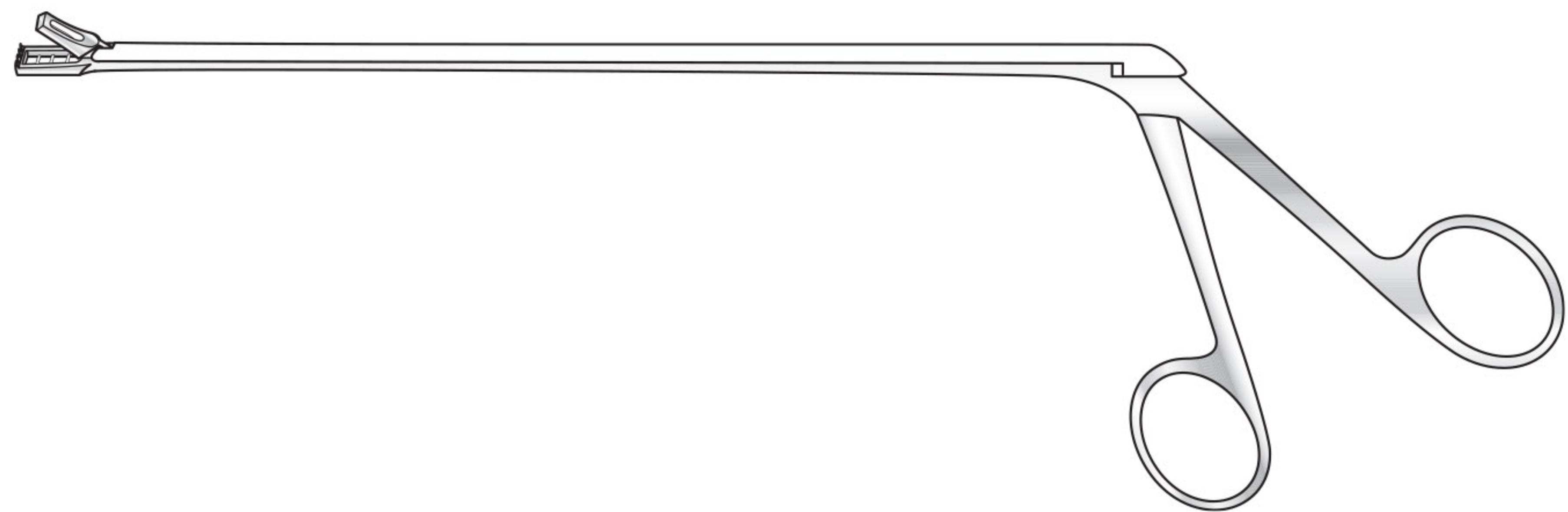

Code	Description
FST-3-261	Jaws curved to side
FST-3-262	Jaws straight to side



# Obstetric Forceps

## Barnes Obstetric Forcep

With Simpson handles and Neville axis traction rod

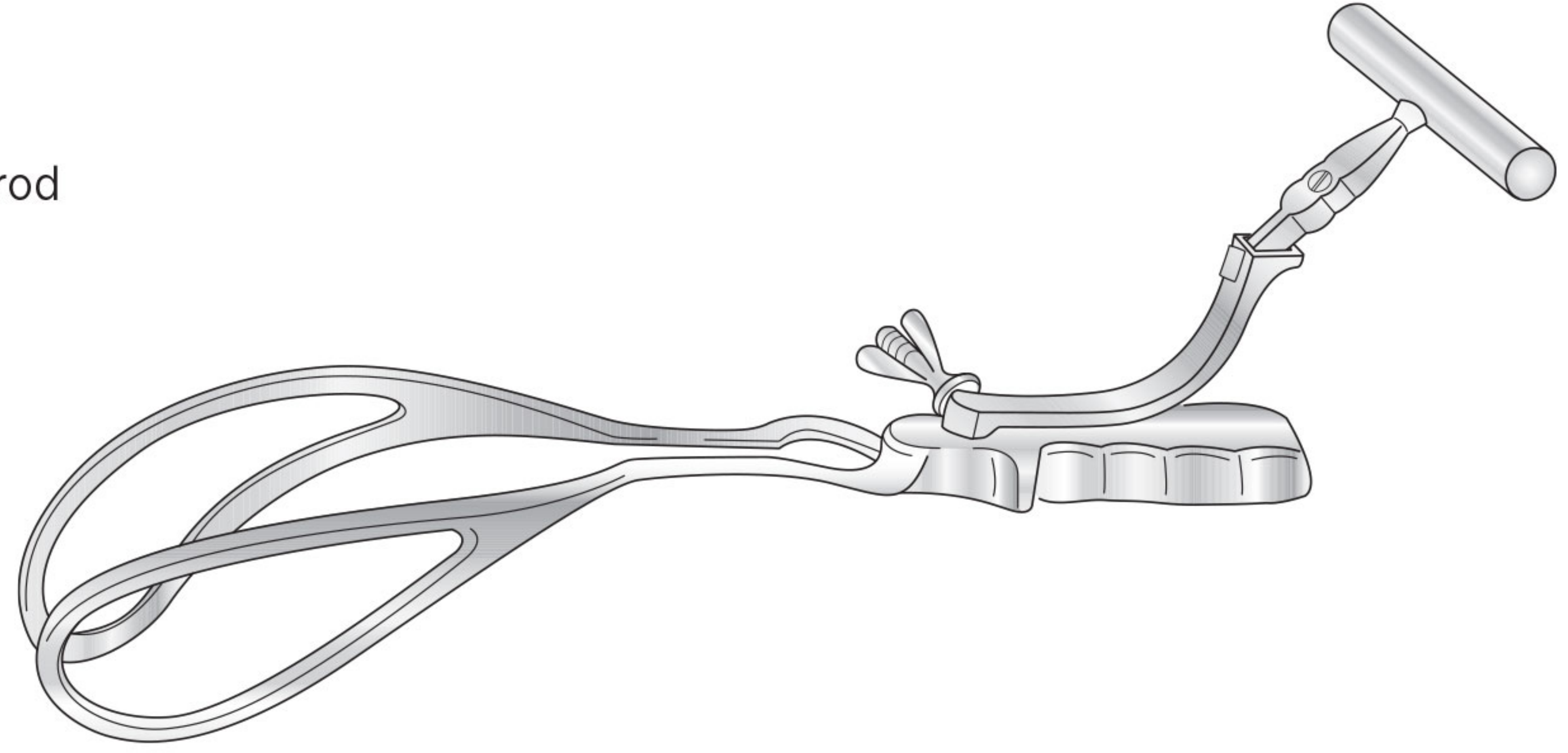

Code	Description
FST-3-270	381mm long

## Haig Ferguson Obstetric Forcep

Tape slots in blades and axis traction rod

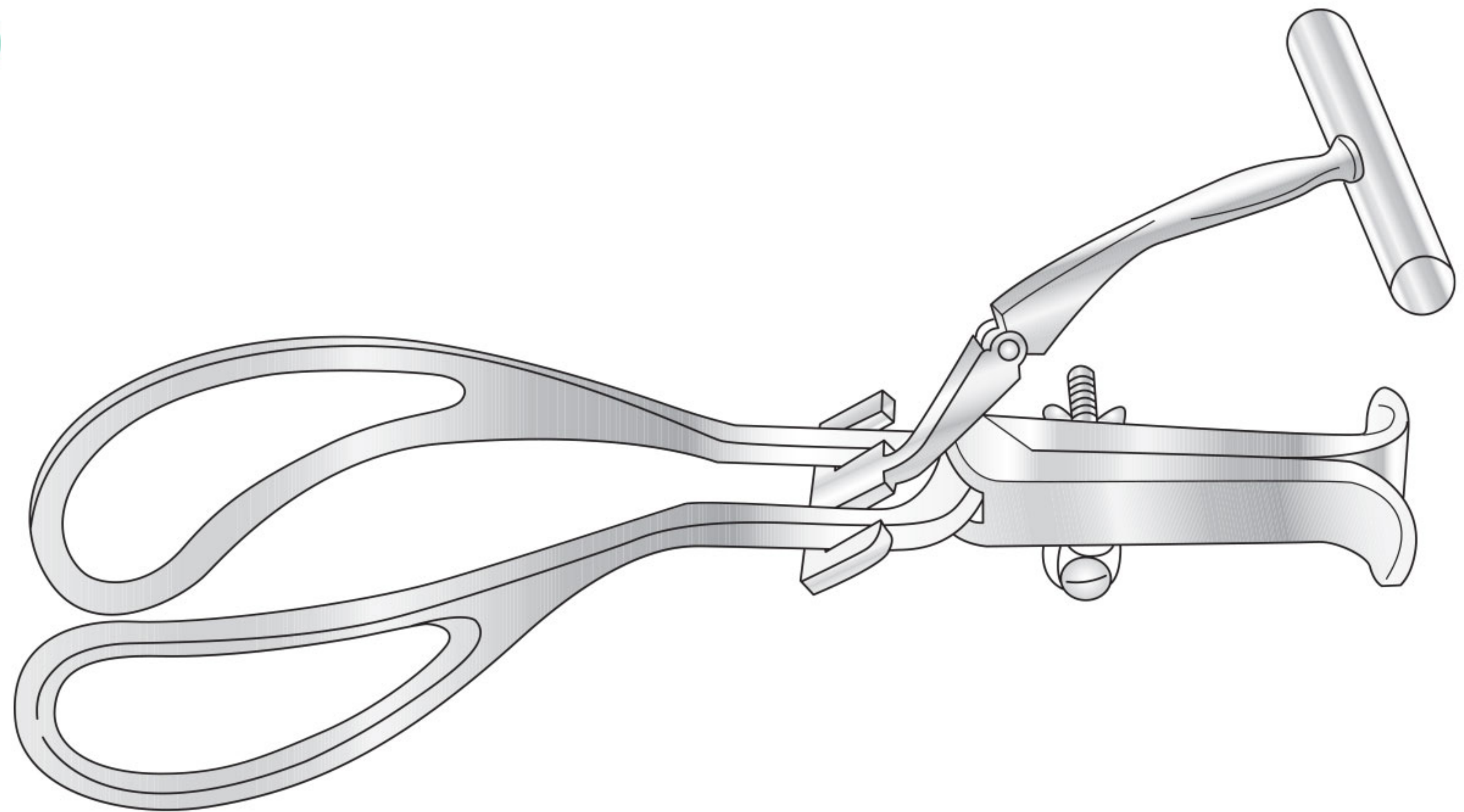

Code	Description
FST-3-271	356mm long

## Kieland Obstetric Forcep

Matt finish

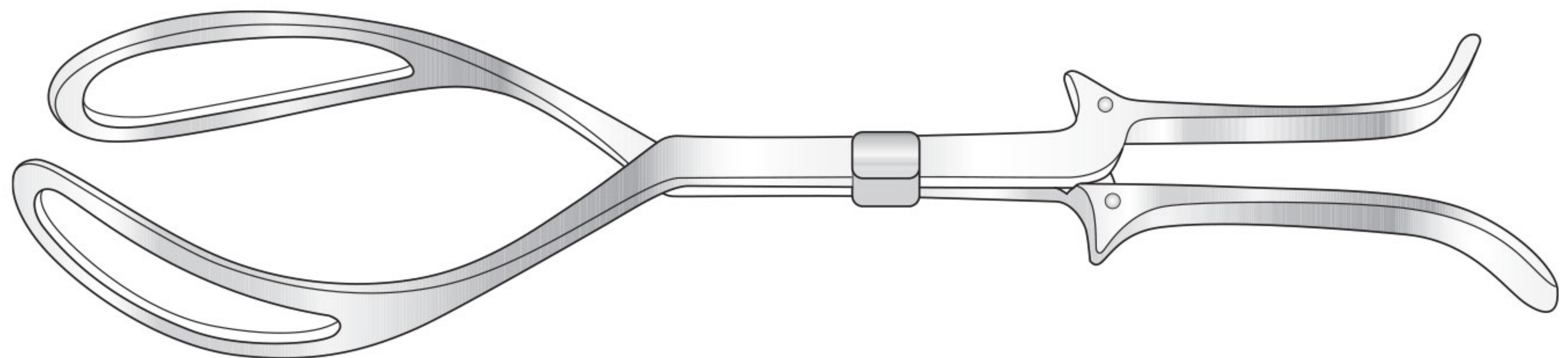

Code	Description
FST-3-272	410mm long

## Simpson Braun Obstetric Forcep

Matt finish

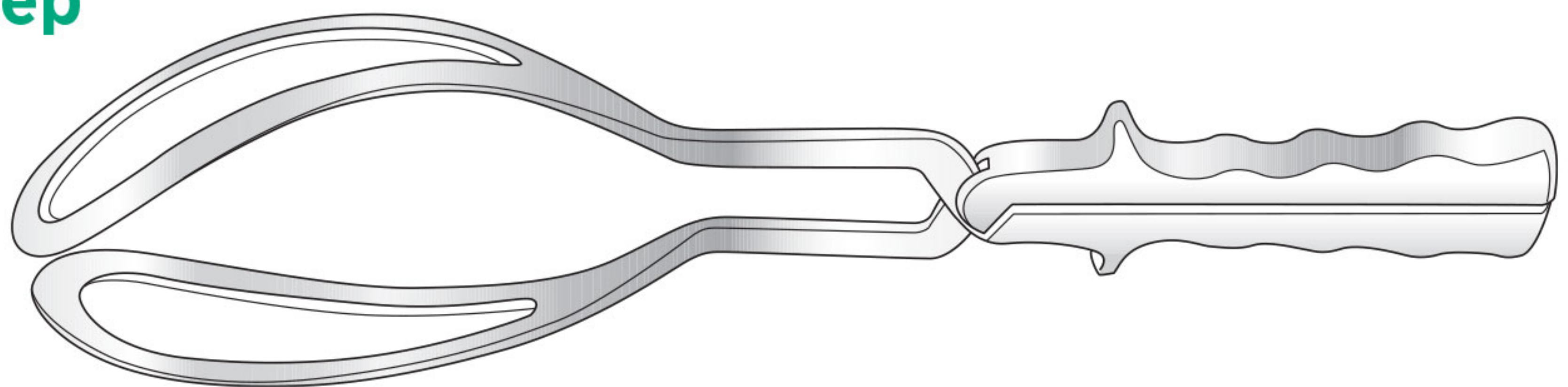

Code	Description
FST-3-273	380mm long

## Wrigley Obstetric Forcep

Short model for caesarian section

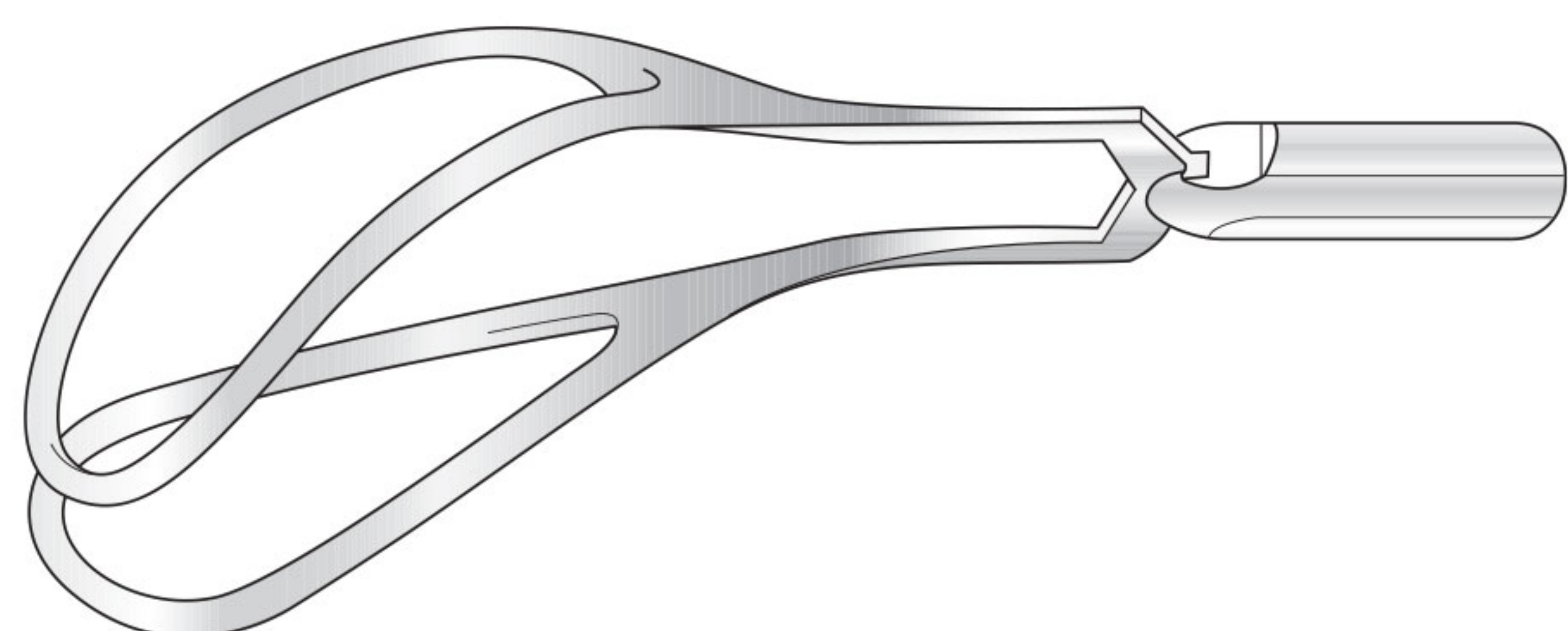

Code	Description
FST-3-274	279mm long



## Auvarod Vaginal Speculum

Weighted

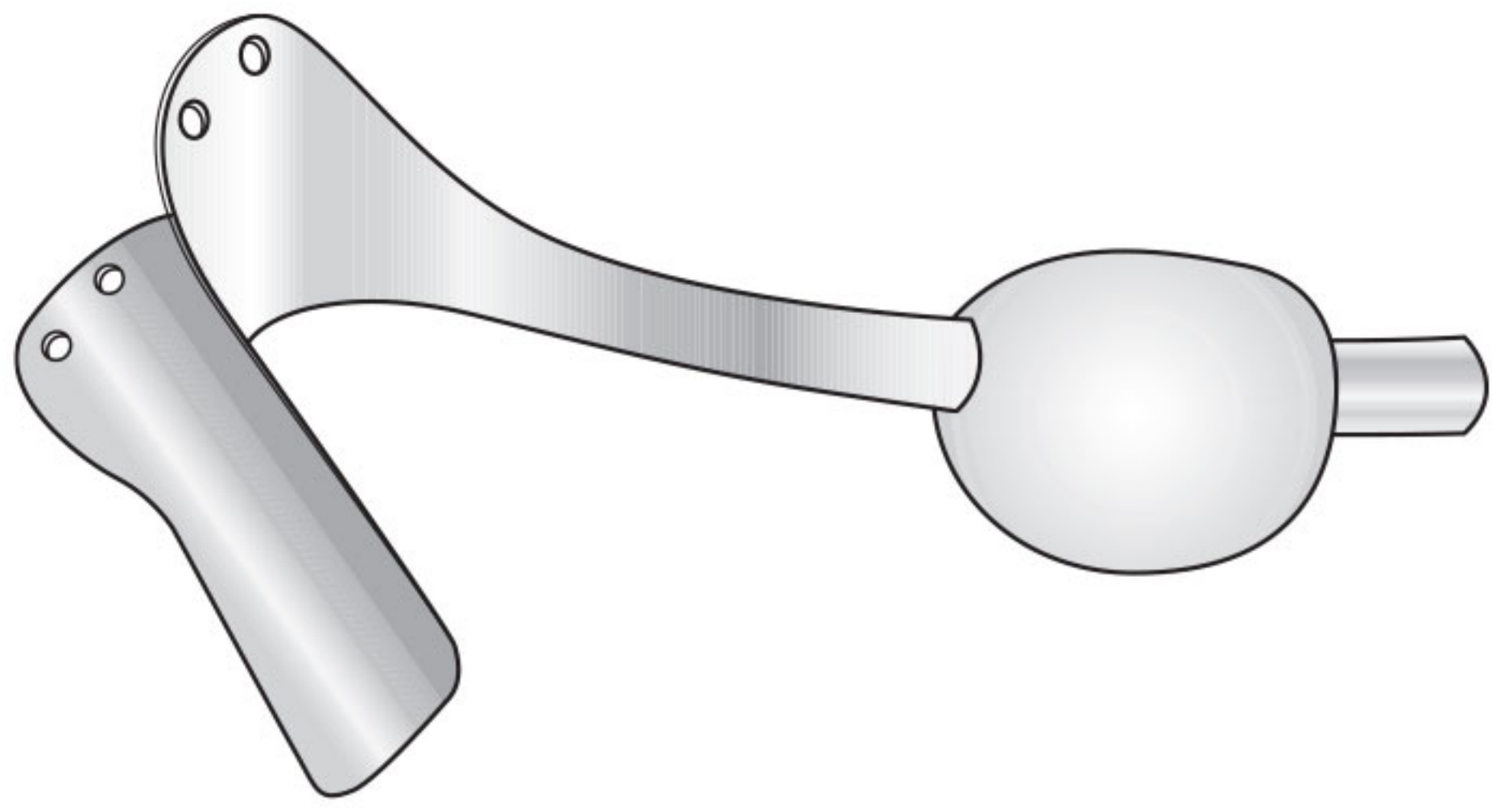

Code	Description
FST-3-280	Small blade 38 x 90mm
FST-3-281	Large blade 51 x 90mm

## Collin Vaginal Speculum

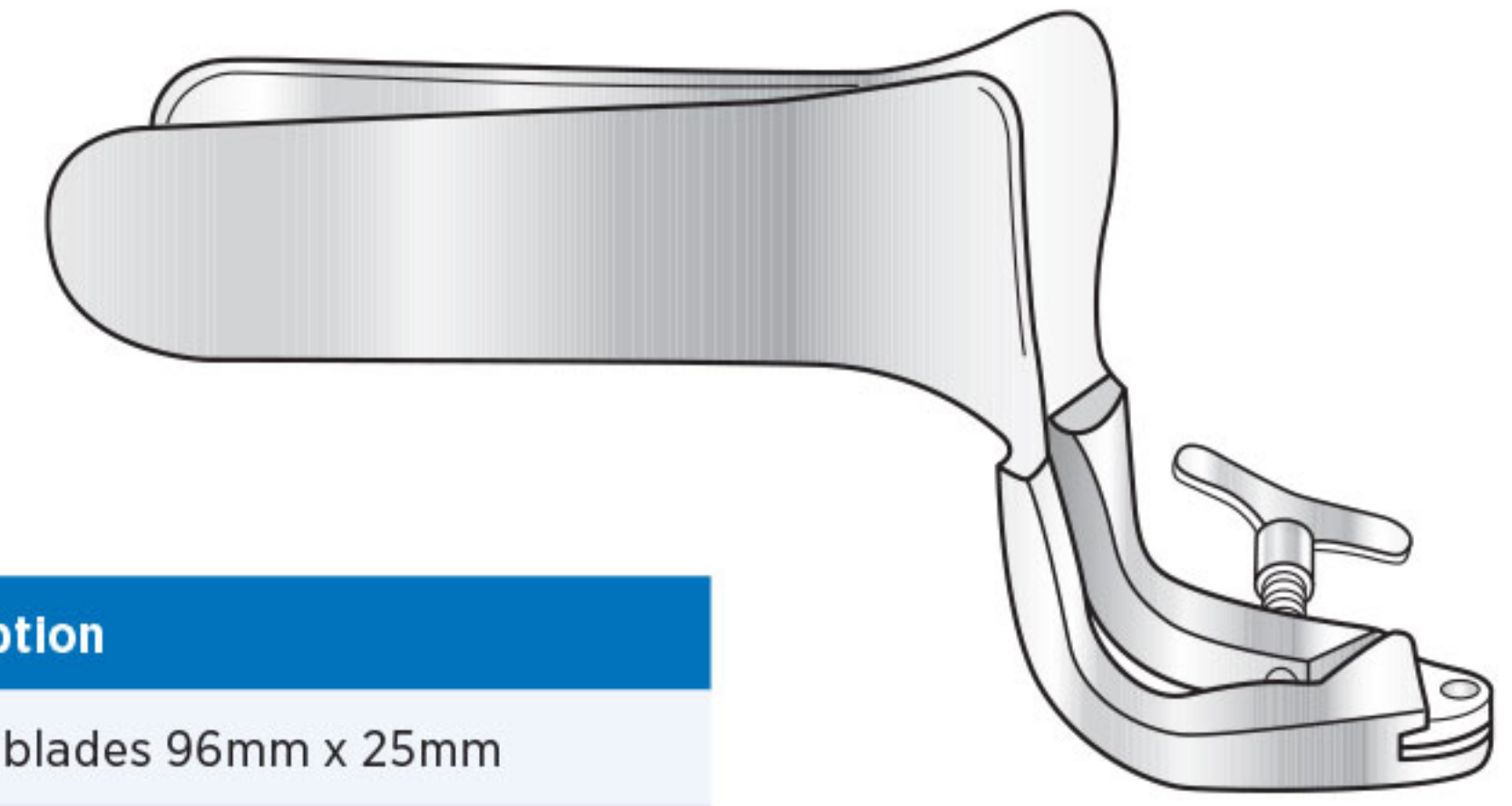

Code	Description
FST-3-283	Small - blades 96mm x 25mm
FST-3-284	Medium - blades 108mm x 30mm
FST-3-285	Large - blades 108mm x 35mm

## Graves Vaginal Speculum

Bright finish



Code	Description
FST-3-286	115 x 35mm

## Nott Speculum

Stainless steel

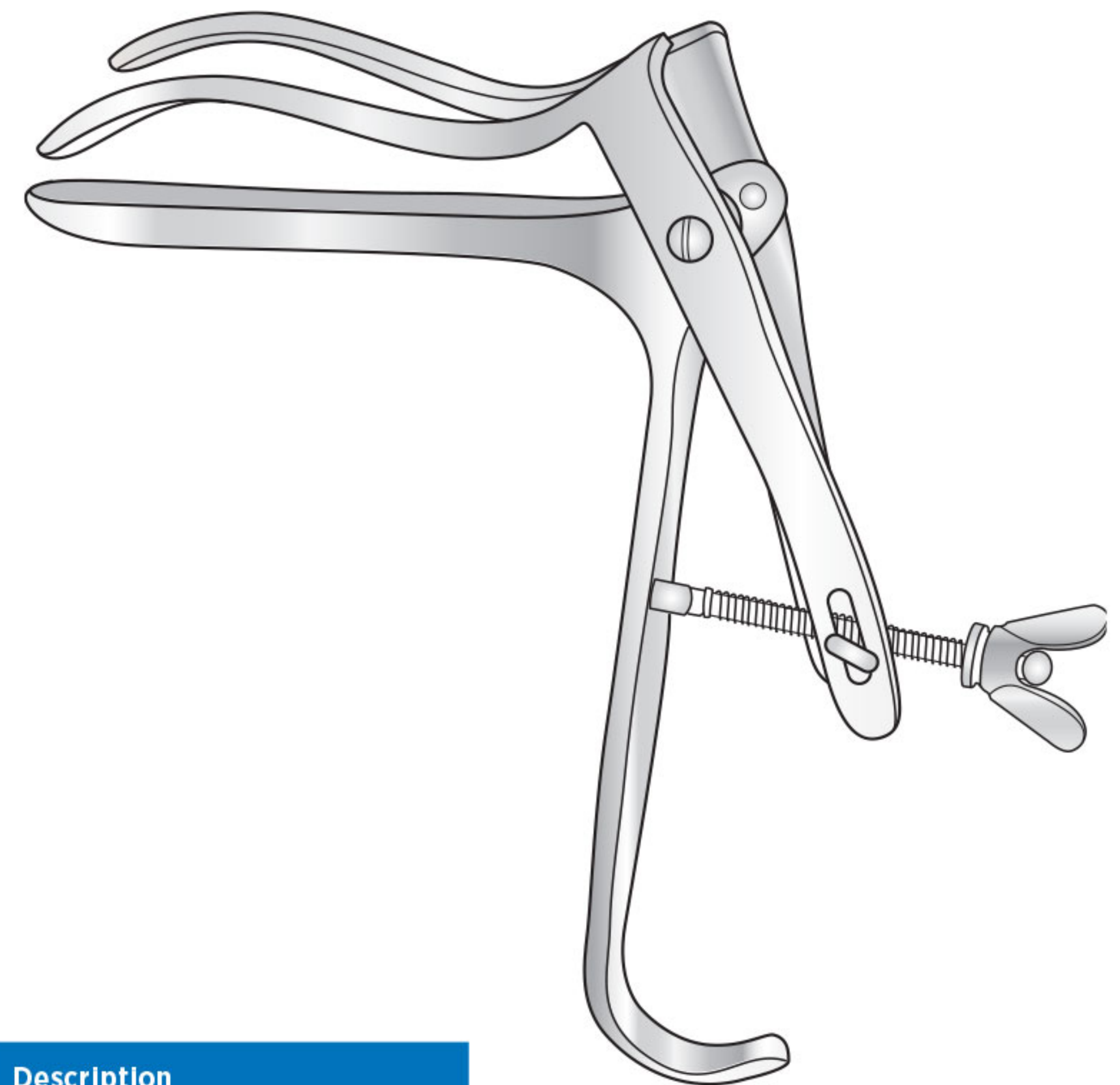

Code	Description
FST-3-287	Blade 110mm long, 30mm wide

## Cusco Vaginal Speculum

Stainless steel

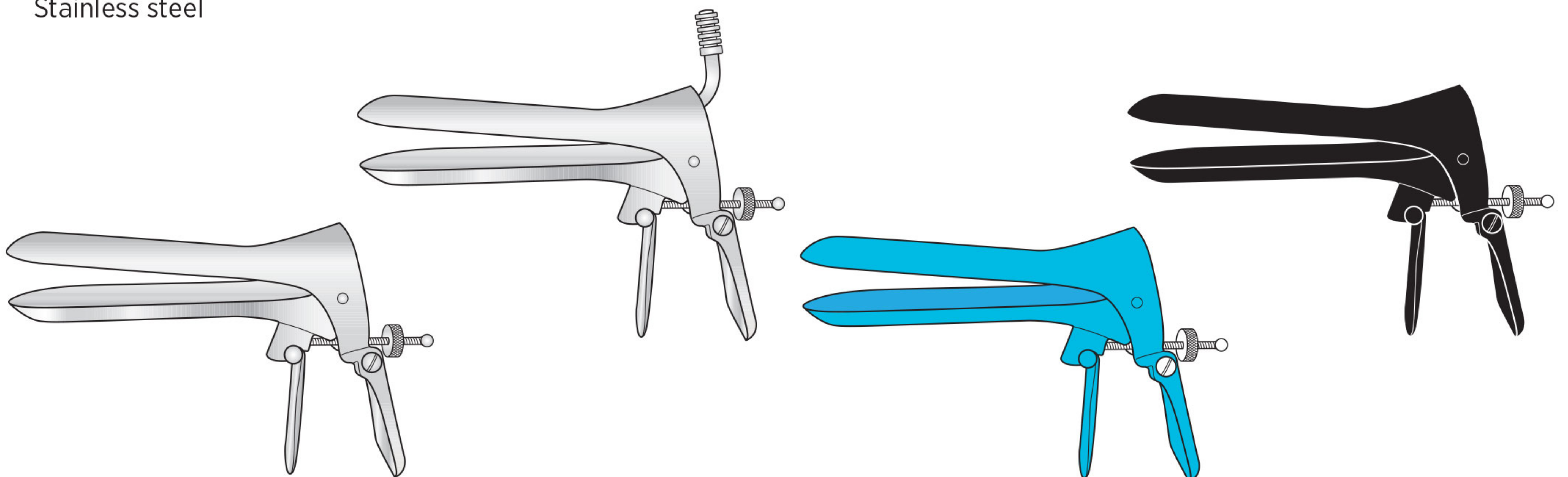

### Insulated

Code	Description
FST-3-290	Extra small - 98mm x 16mm
FST-3-291	Small - 105mm x 25mm
FST-3-292	Medium - 107mm x 29mm
FST-3-293	Large - 115mm x 35mm

Code	Description
FST-3-294	Small - 105mm x 25mm
FST-3-295	Medium - 107mm x 29mm
FST-3-296	Large - 115mm x 35mm
FST-3-297	Extra large - 135mm x 38mm

### With Suction Tube

Code	Description
FST-3-298	Small - 105mm x 25mm
FST-3-299	Medium - 107mm x 29mm
FST-3-300	Large - 115mm x 35mm
FST-3-301	Extra large - 135mm x 38mm

### Black Finish

Code	Description
FST-3-302	Small - 105mm x 25mm
FST-3-303	Medium - 107mm x 29mm
FST-3-304	Large - 115mm x 35mm
FST-3-305	Extra large - 135mm x 38mm



# Speculum

## Pederson Vaginal Speculum

Stainless steel

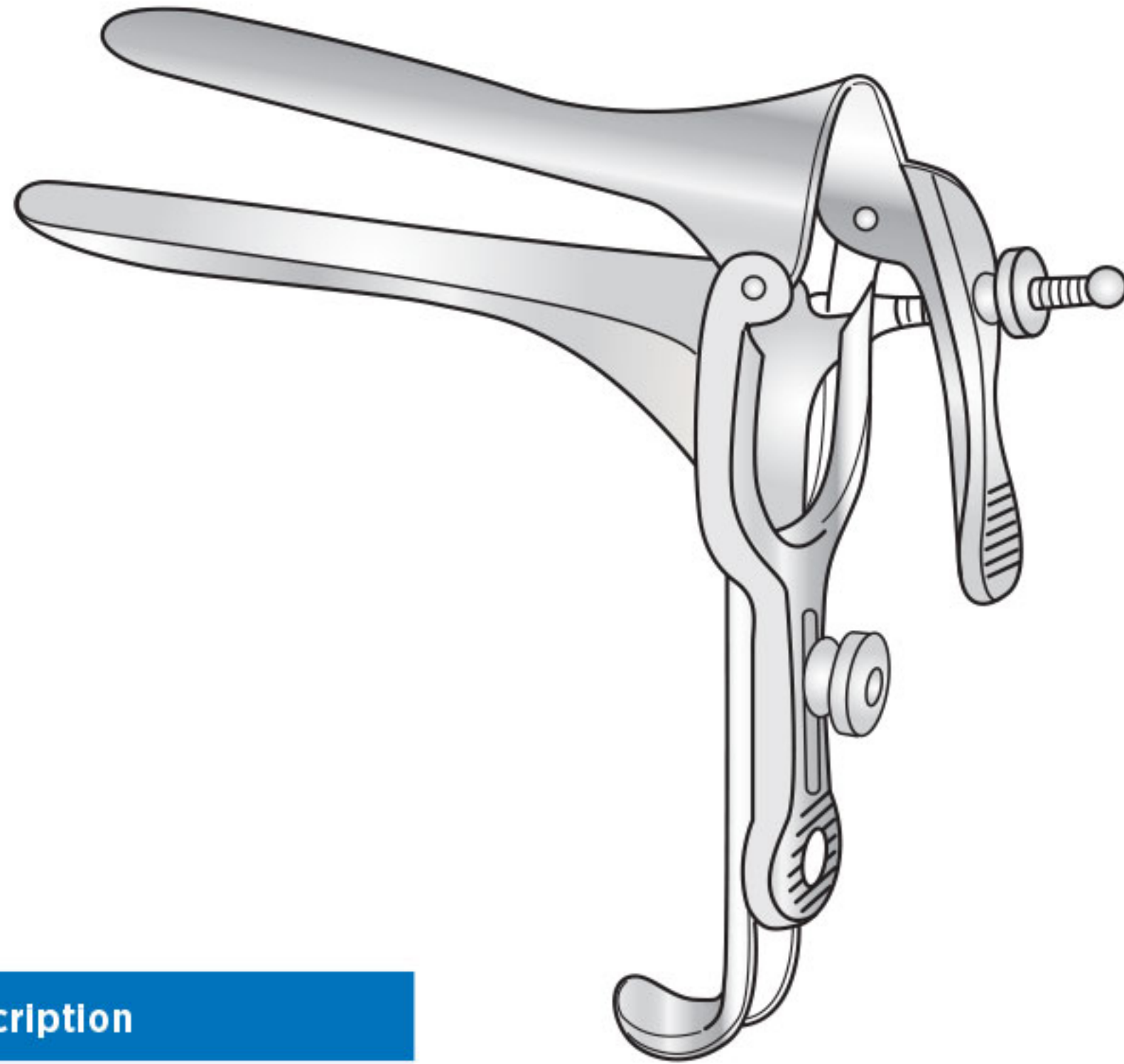

Code	Description
FST-3-310	120mm x 25mm wide
FST-3-311	90mm x 20mm wide

## Winterton Vaginal Speculum

Stainless steel

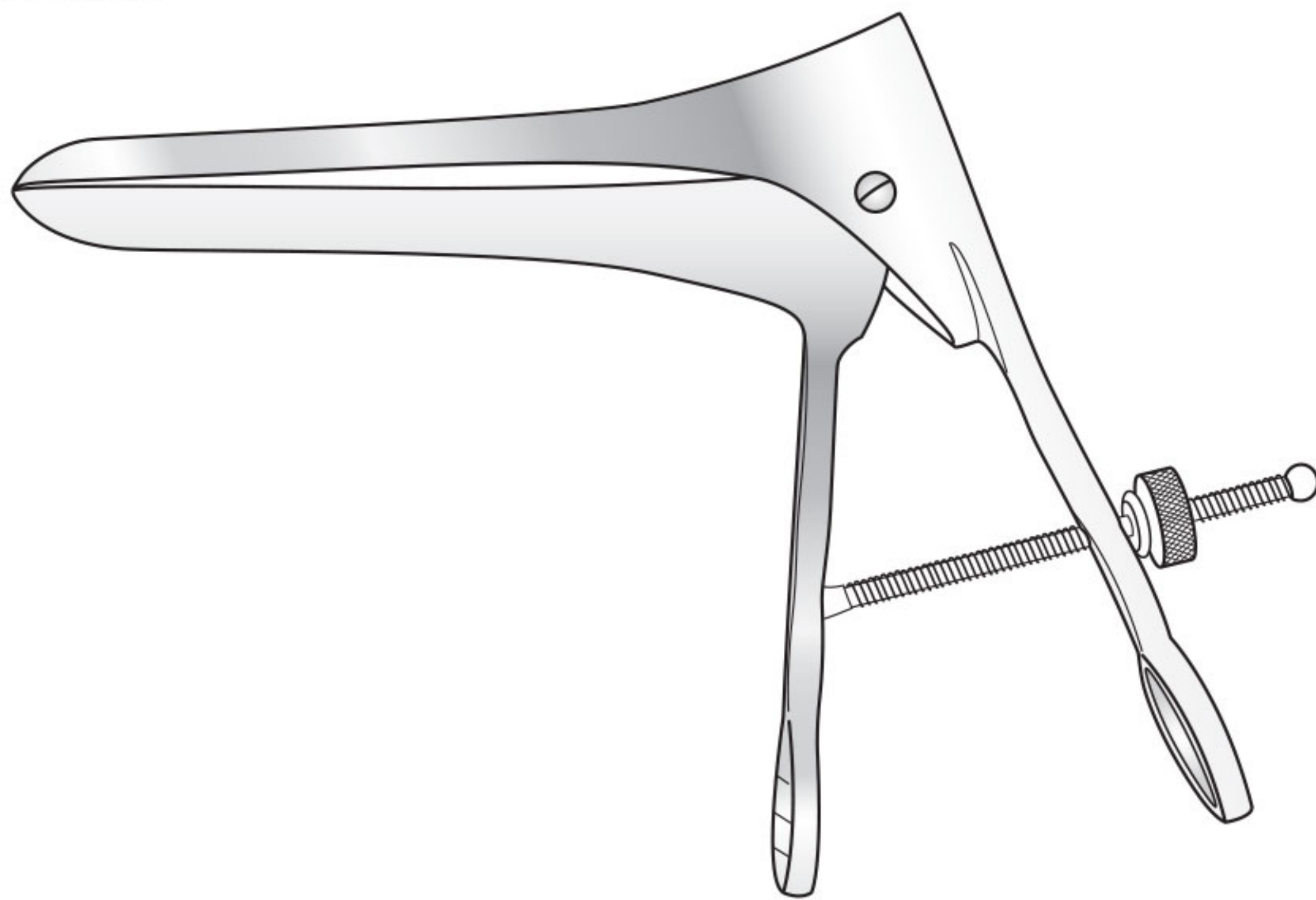

Code	Description
FST-3-318	Blade 115mm long, 25mm wide

## Modified Speculum

Stainless steel, for elderly patients

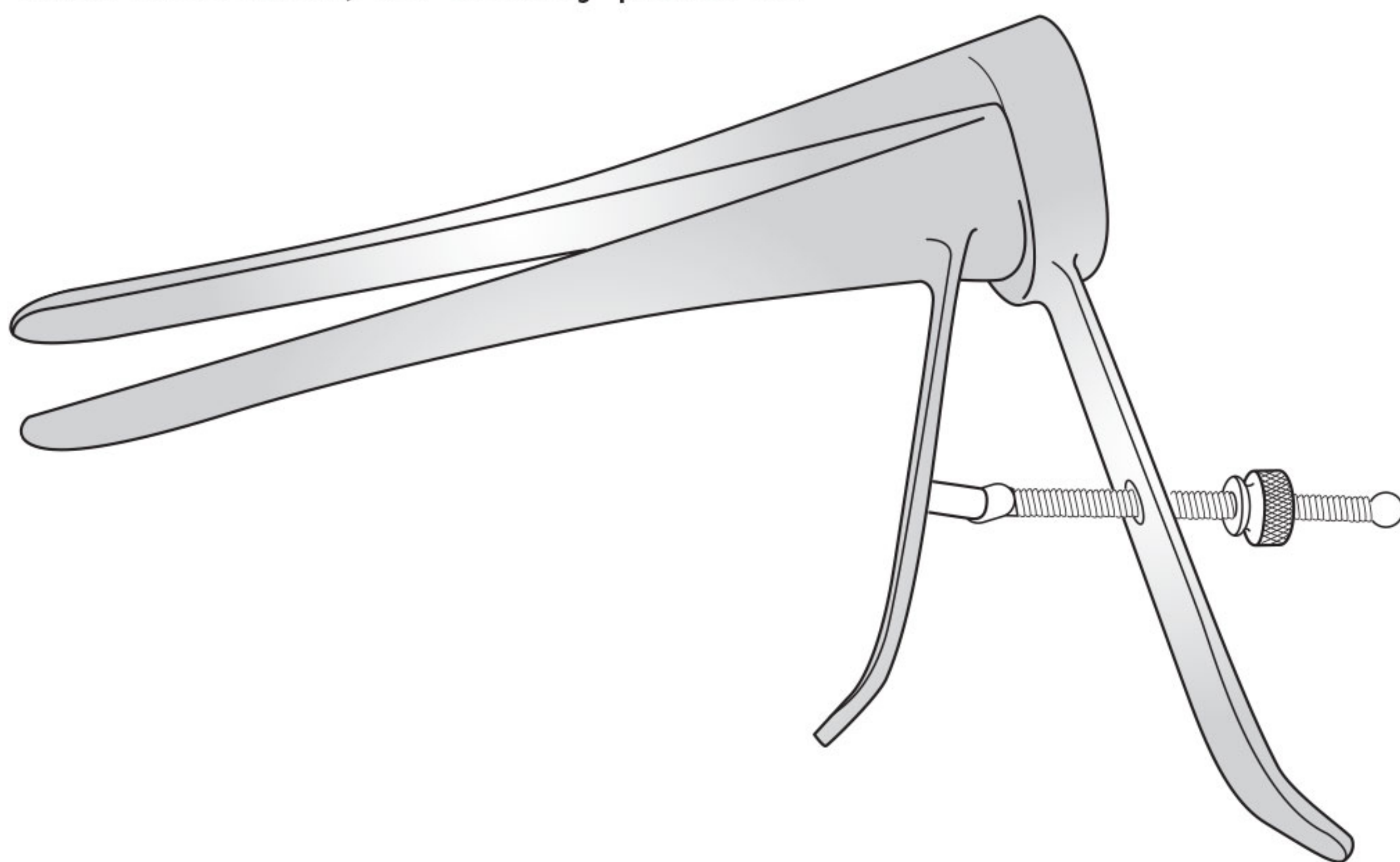

Code	Description
FST-3-330	Blade 180mm long, 18mm wide

## Sims Duckbill Speculum

Double ended

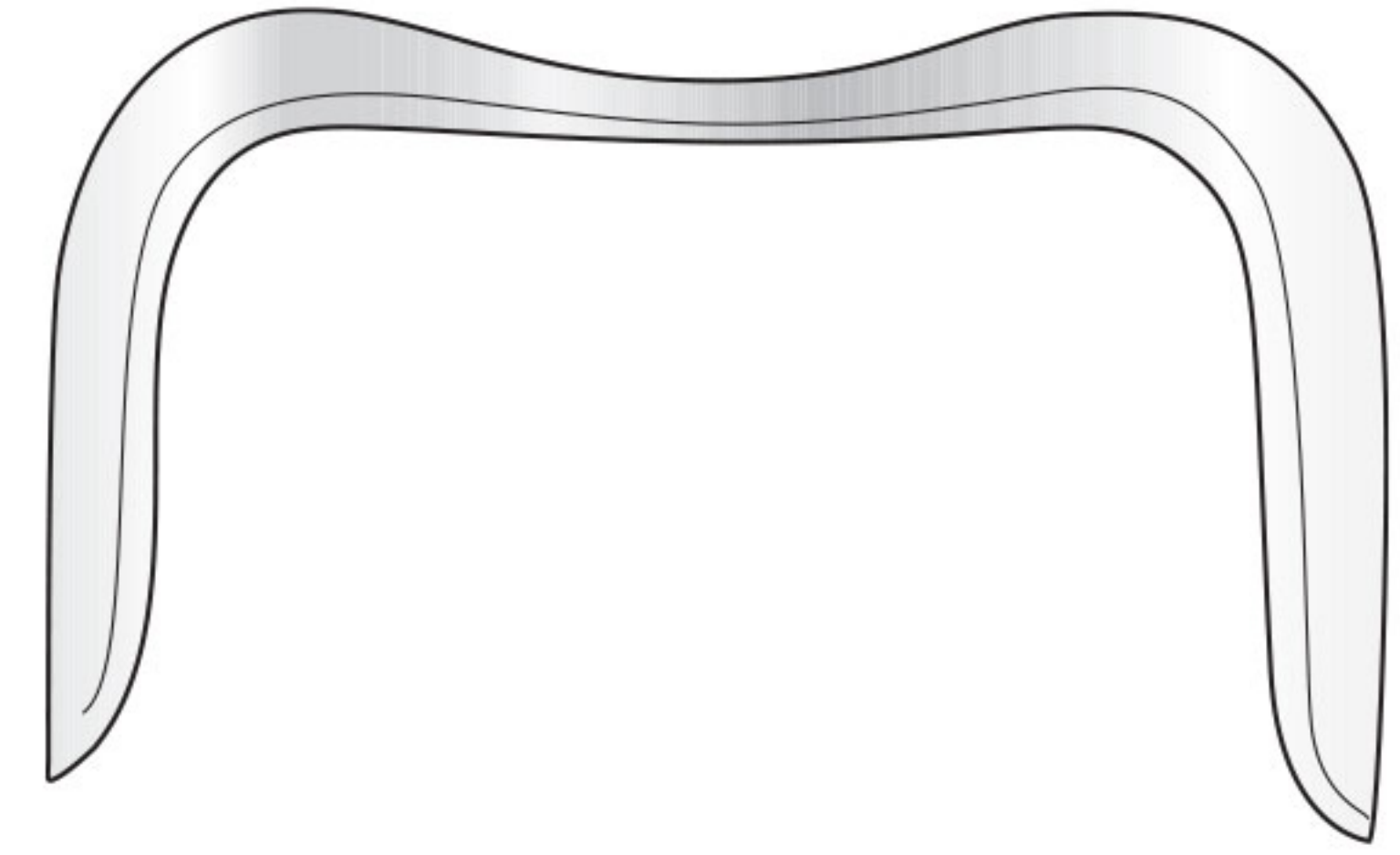

Code	Description
FST-3-313	Small - 27mm x 29mm x 130mm long
FST-3-314	Medium - 30mm x 33mm x 158mm long
FST-3-315	Large - 33mm x 38mm x 184mm long

## Sims Duckbill Speculum

Double ended, insulated

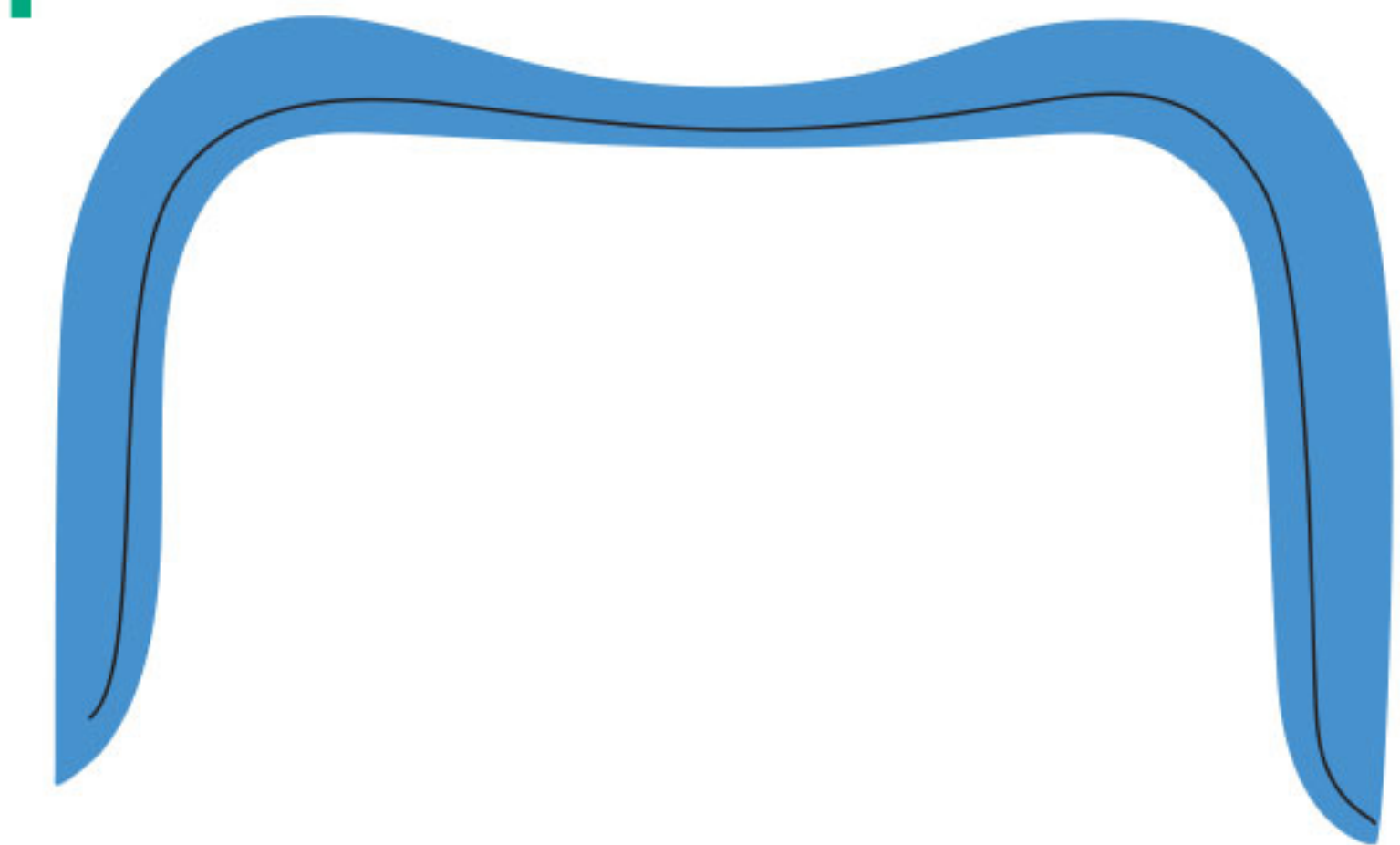

Code	Description
FST-3-323	Small - 27mm x 29mm x 130mm long
FST-3-324	Medium - 30mm x 33mm x 158mm long
FST-3-325	Large - 33mm x 38mm x 184mm long



## Breisky Vaginal Retractor

Bright finish, matt handle  
320mm long

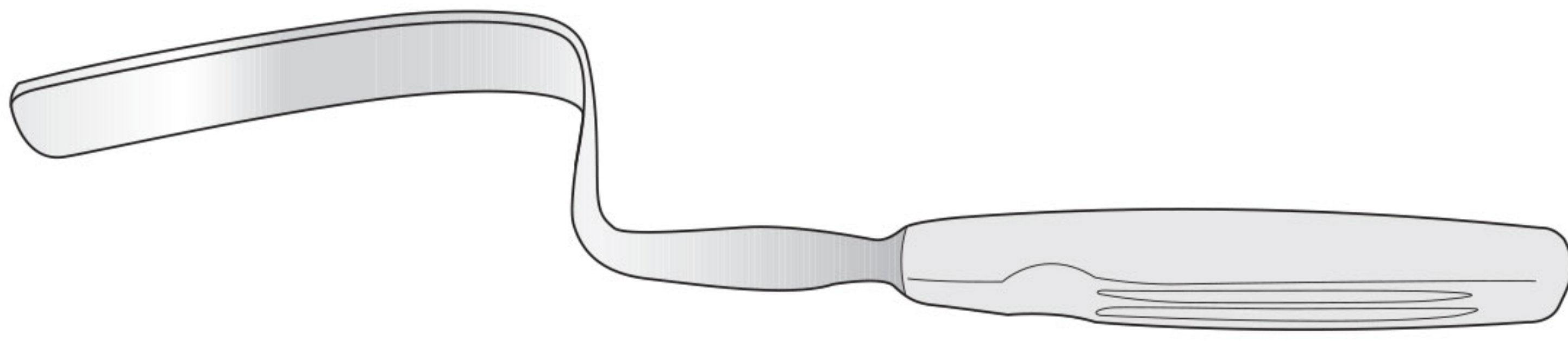

Code	Description
FST-3-340	25mm blade

## Doyen Retractor

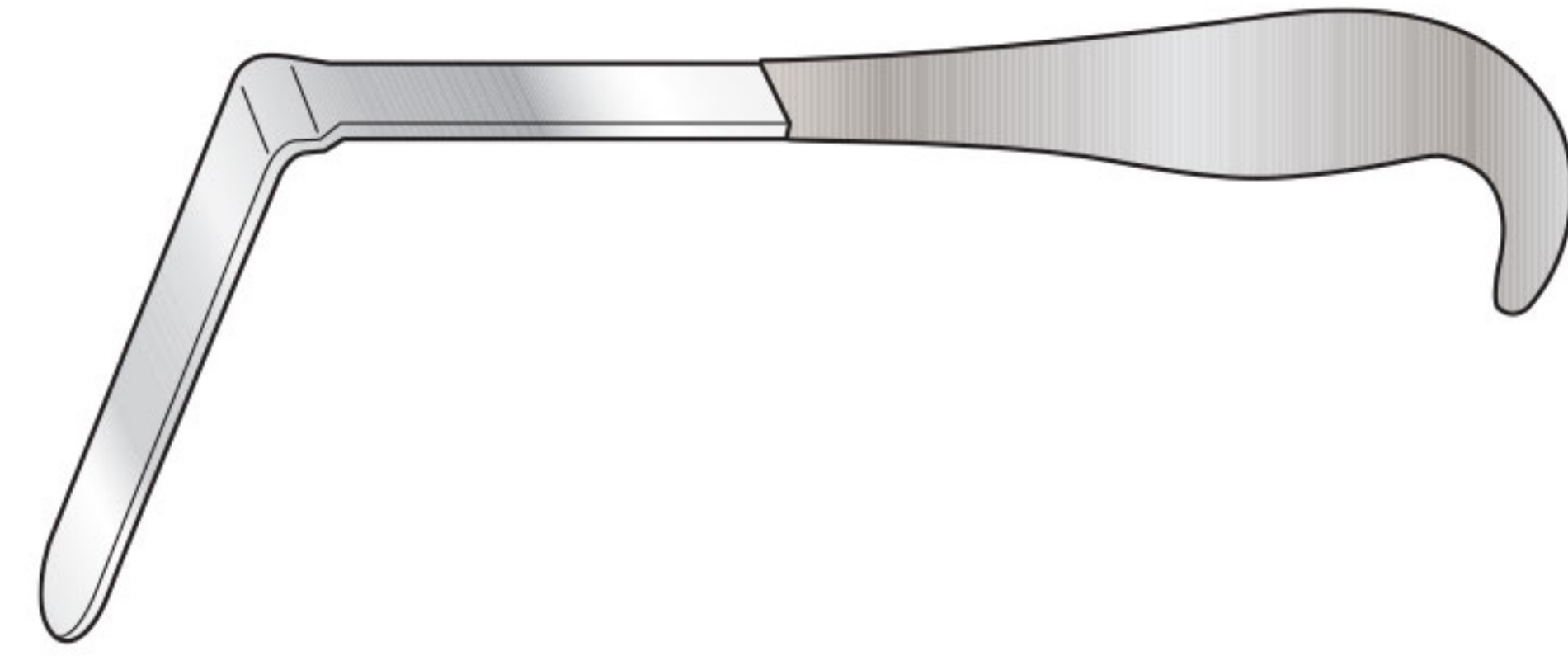

Code	Description
FST-3-341	Blade 100mm x 30mm

## Doyen Rectangular Retractor

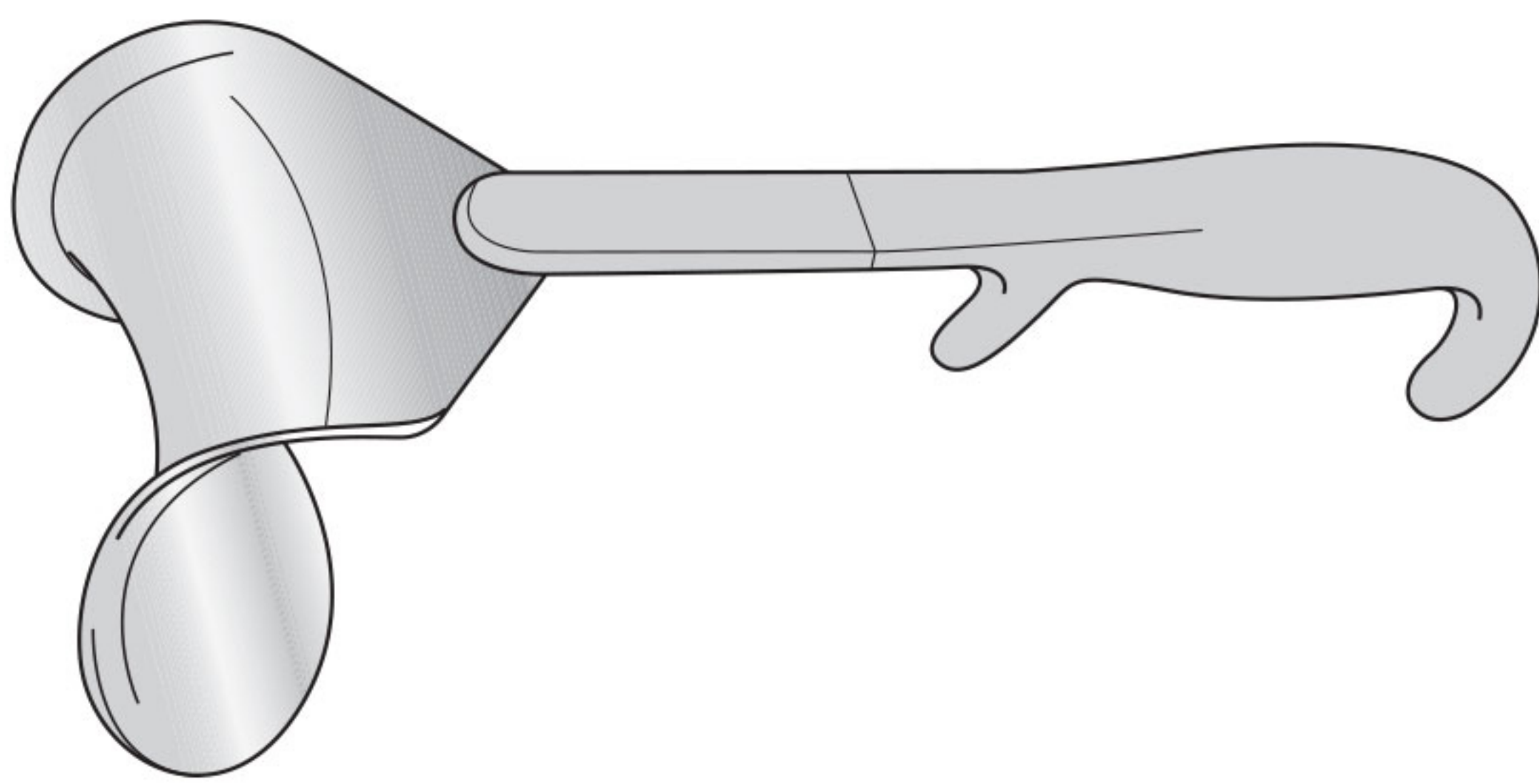

Code	Description
FST-3-344	Small - 48 x 60mm
FST-3-345	Medium - 48 x 89mm
FST-3-346	Large - 48 x 124mm

## St Mark's Hospital Pattern Retractor

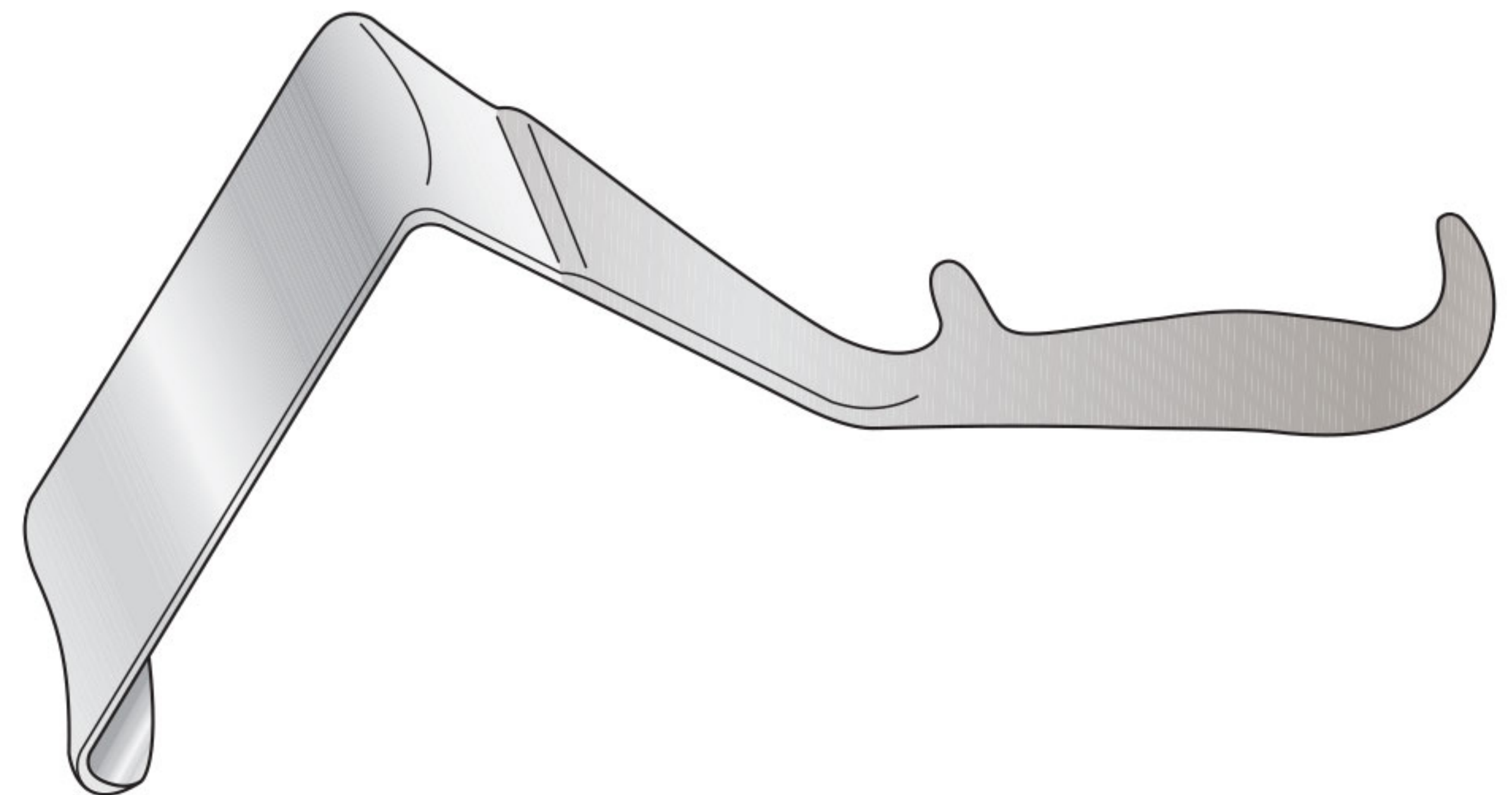

### With lip

Code	Description
FST-3-350	Blade 125mm x 60mm
FST-3-351	Blade 175mm x 60mm

### Without lip

Code	Description
FST-3-352	Blade 125mm x 60mm
FST-3-353	Blade 175mm x 60mm

## Doyen Retractor

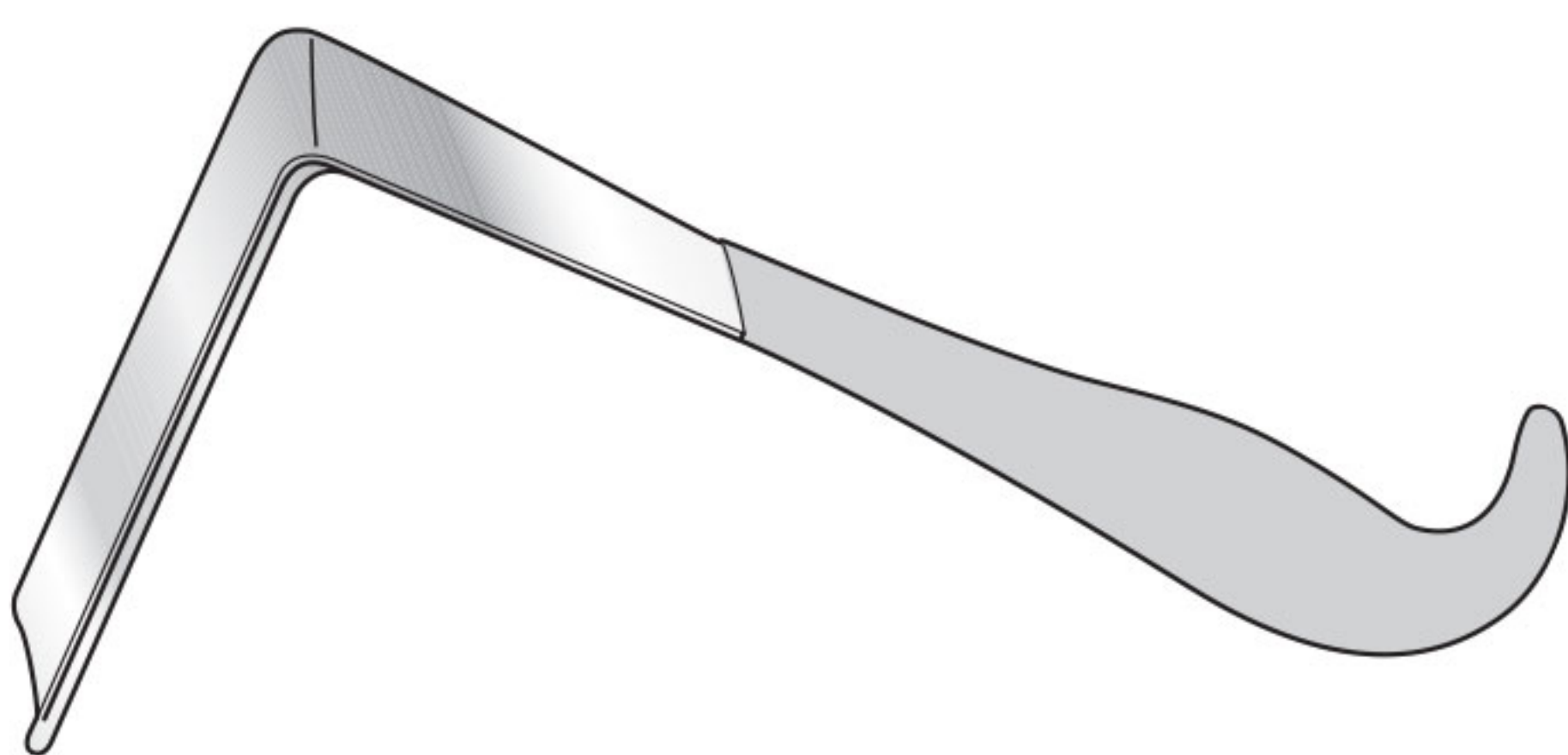

Code	Description
FST-3-354	Blade 95mm x 27mm

## Wertheim Retractor

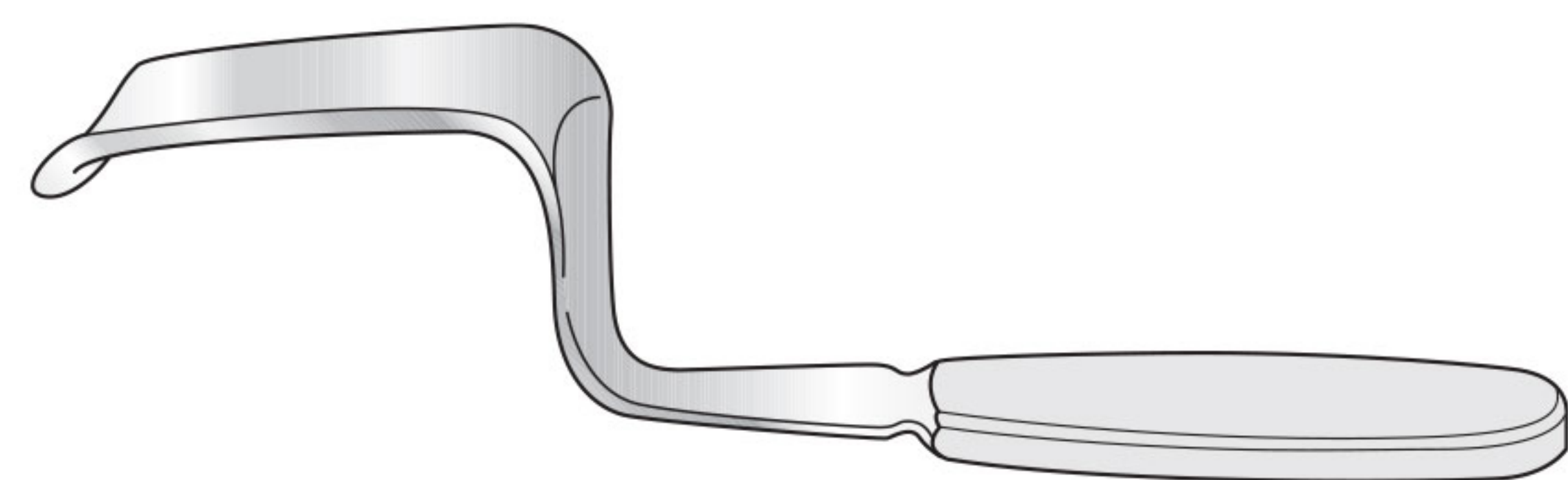

Code	Description
FST-3-355	Blade 95mm x 38mm



# Retractors

## Landon Vaginal Retractor

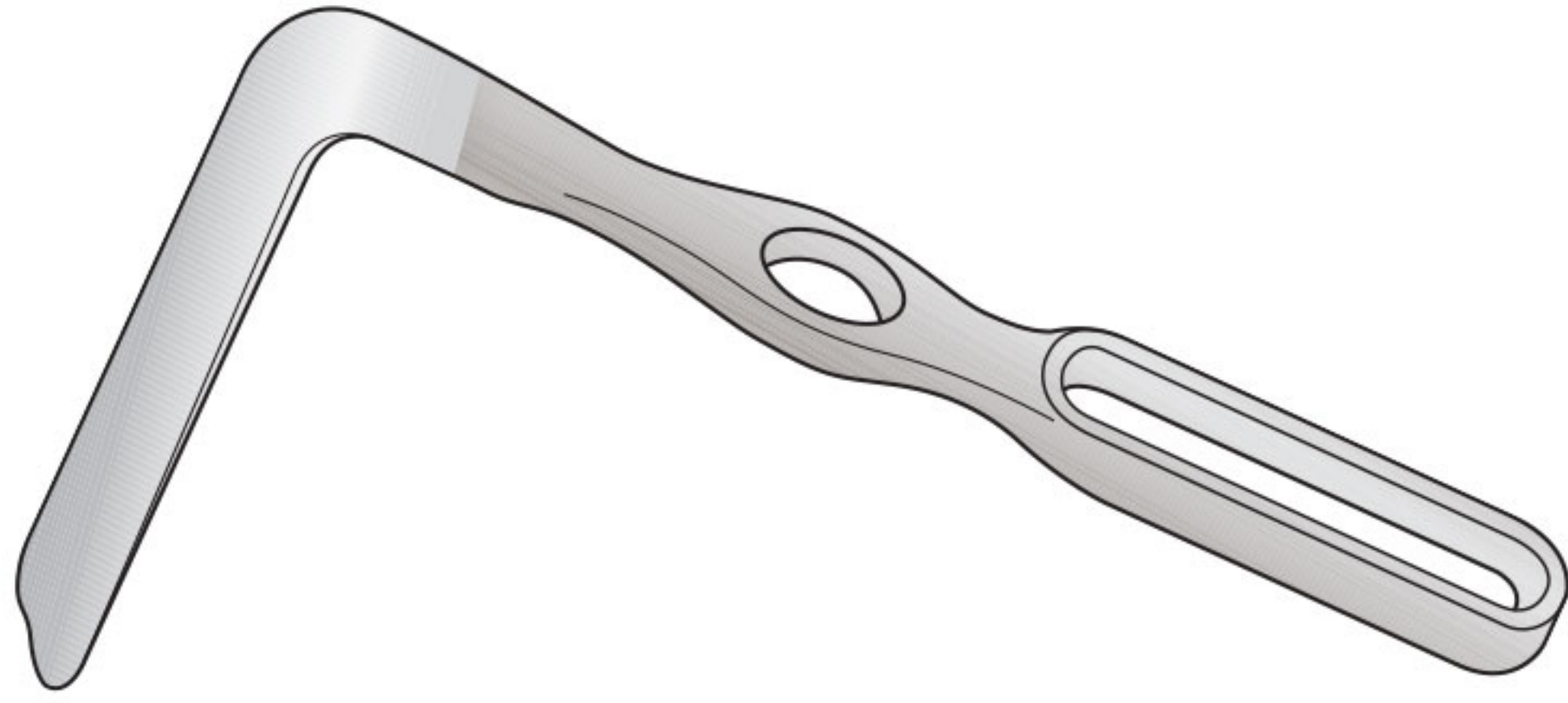

Code	Description
FST-3-360	Blade 89mm x 25mm

## Lateral Vaginal Retractor

Blades bright finish, matt handle

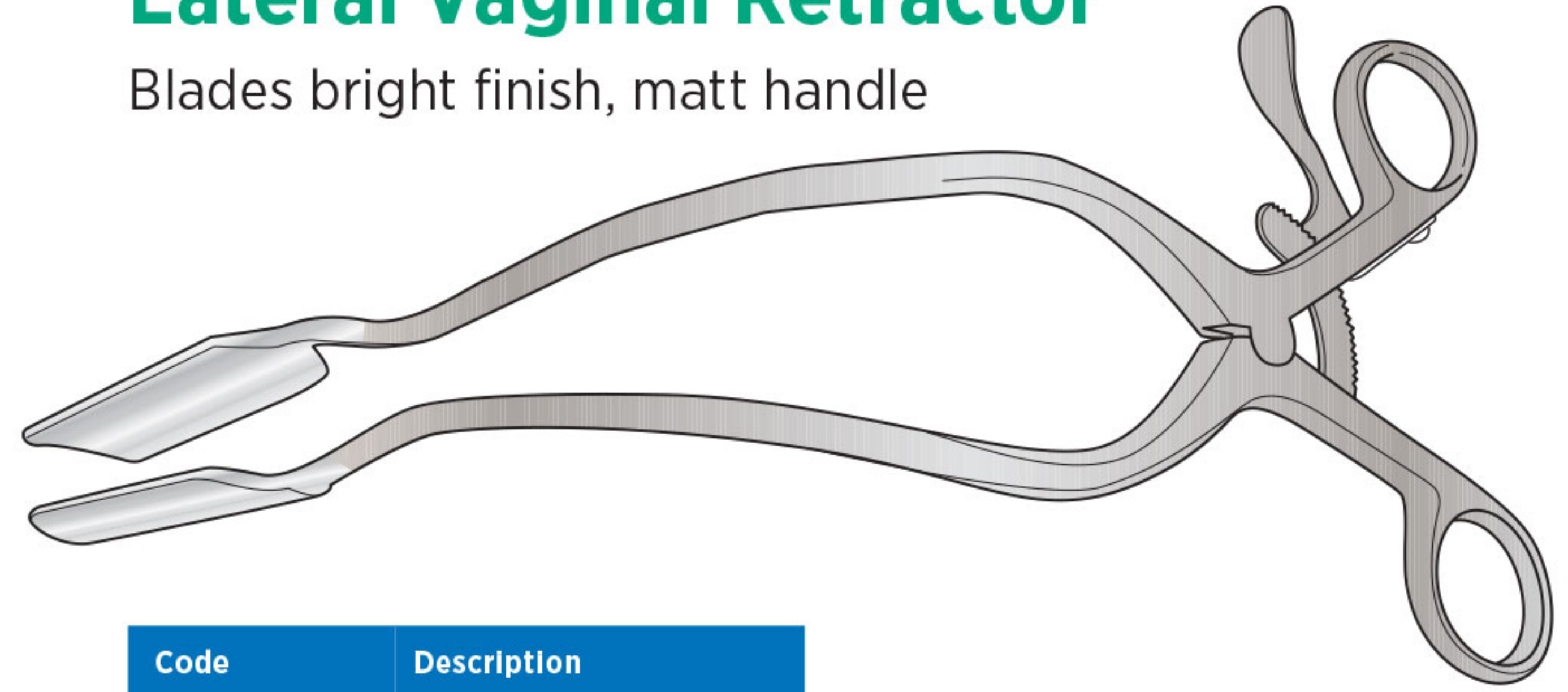

Code	Description
FST-3-361	60 x 20mm blade
FST-3-362	75 x 22mm blade
FST-3-363	110 x 23mm blade

AVAILABLE INSULATED  
ADD SUFFIX 'INS'

## Whitlow Retractor

Vaginal retractor, for use with supplied blades. Points of retraction move around almost 360°. Supplied complete with sterilising basket and three sets of blades.

### Frame

225mm at widest point

### Blades

1 x anterior and 1 x posterior 90°, 25mm x 100mm

2 x lateral 90°, 25mm x 70mm

2 x lateral 75°, 25mm x 70mm

Code
FST-3-364

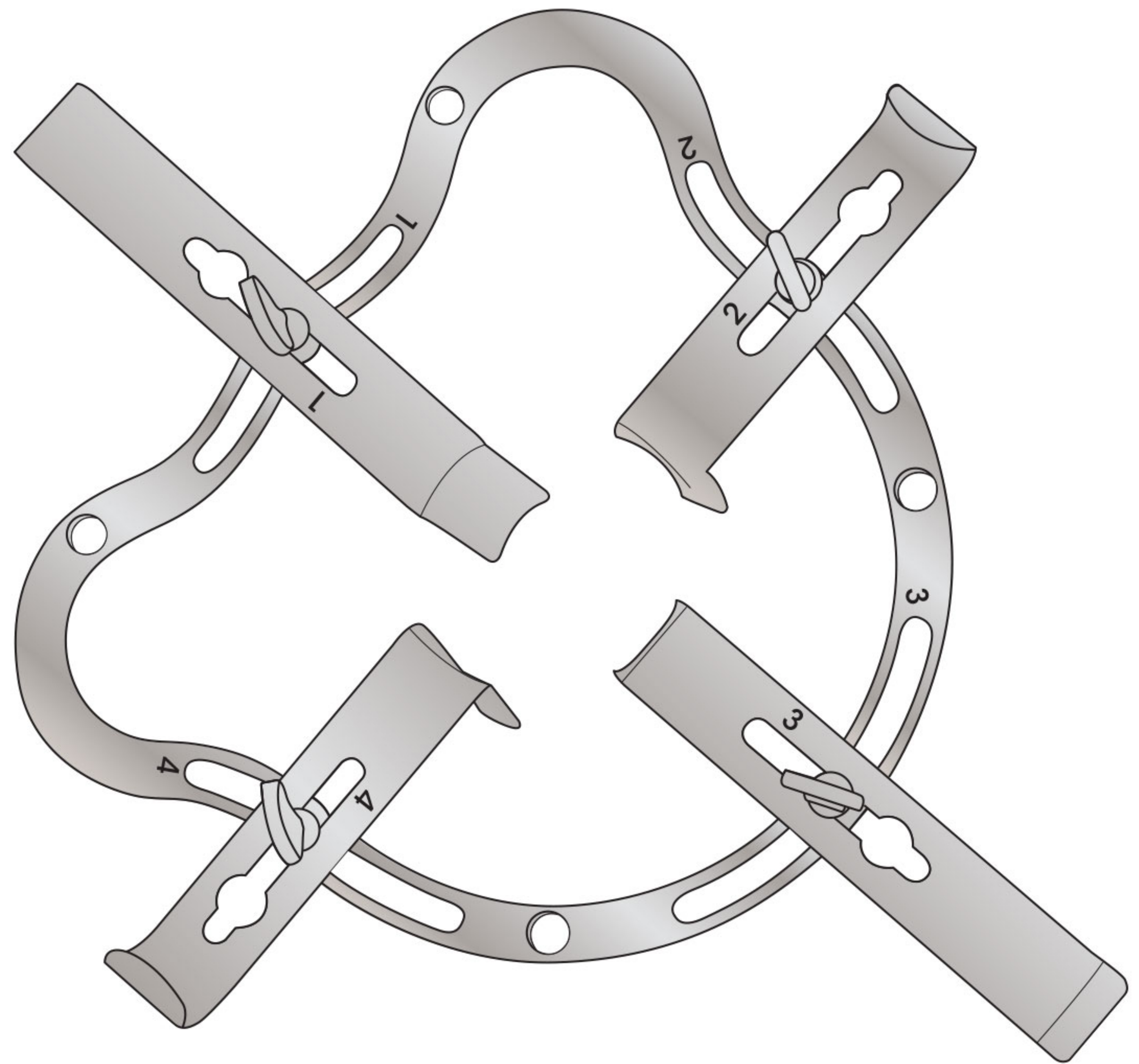
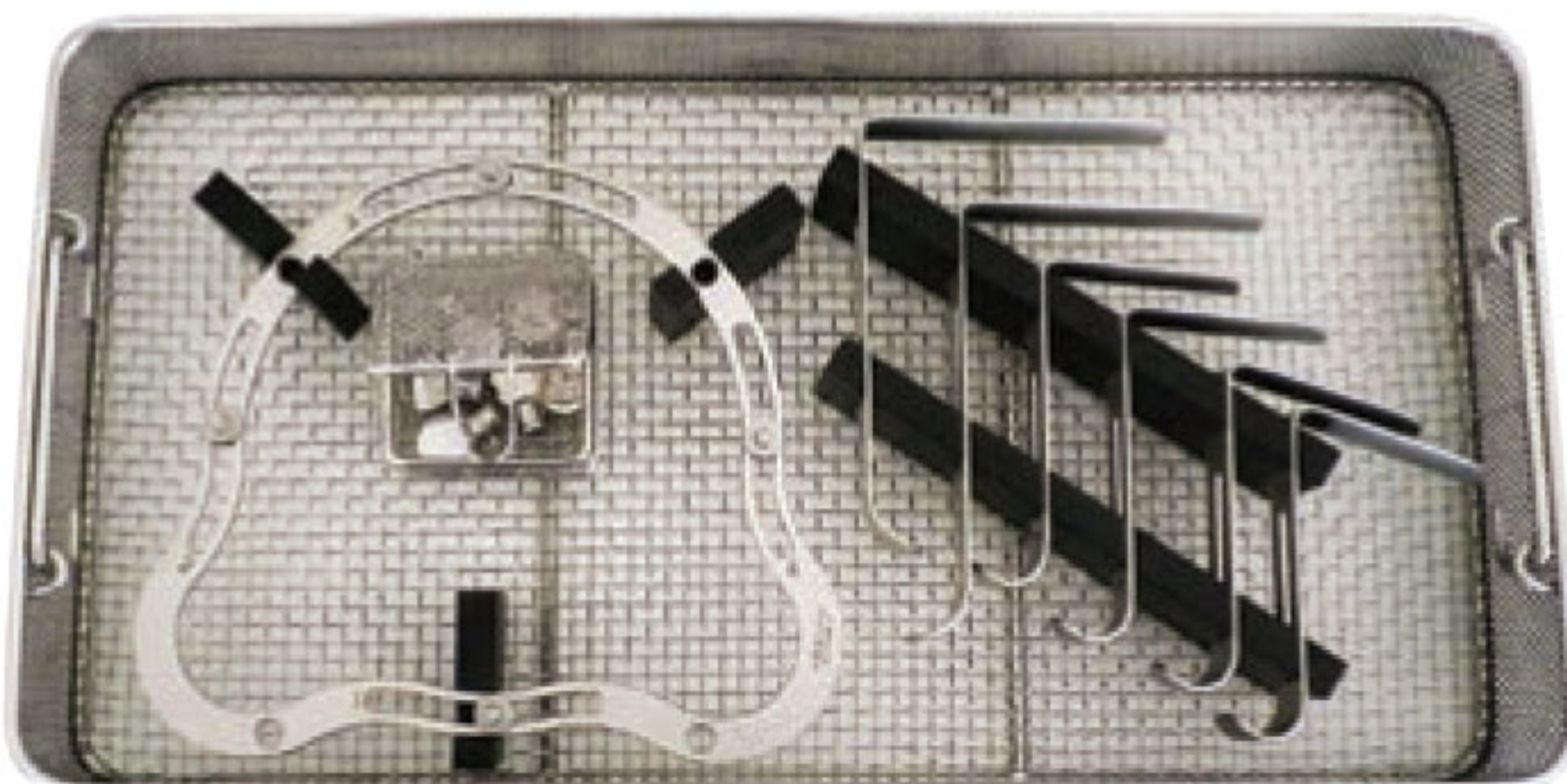



### Kevorkian Biopsy Curette

313mm long

Code	Description
FST-3-370	With basket
FST-3-371	Without basket



### Novak Curette

Code	Description
FST-3-372	230mm long



### Recamier Uterine Curette

Matt finish, 310mm long

Code	Description
FST-3-373	Blunt
FST-3-374	Sharp



### Rheinstadter Flushing Curette

290mm long

#### Sharp

Code	Description
FST-3-375	Sharp, 8mm
FST-3-376	Sharp, 14mm

#### Blunt

Code	Description
FST-3-377	Blunt, 8mm
FST-3-378	Blunt, 14mm



### Sims Uterine Curette

Single ended, 255mm long, matt finish

#### Sharp

Code	Description
FST-3-379	Small 6mm
FST-3-380	Medium 10mm
FST-3-381	Large 13mm

#### Blunt

Code	Description
FST-3-382	Small 6mm
FST-3-383	Medium 10mm
FST-3-384	Large 13mm

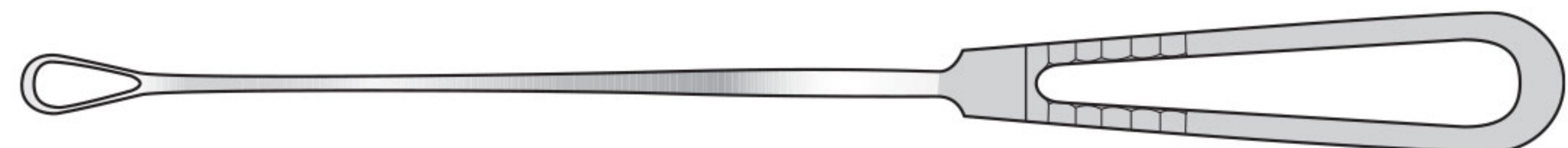

### Sims Uterine Curette

Double ended, 250mm long

#### Sharp

Code	Description
FST-3-385	Small 7 x 5mm
FST-3-386	Medium 10 x 7mm
FST-3-387	Large 13 x 10mm

#### Blunt

Code	Description
FST-3-388	Small 7 x 5mm
FST-3-389	Medium 10 x 7mm
FST-3-390	Large 13 x 10mm





# Catheters

## Rotunda Hospital Pattern Catheter

With solid end, chromium plated, 203mm long

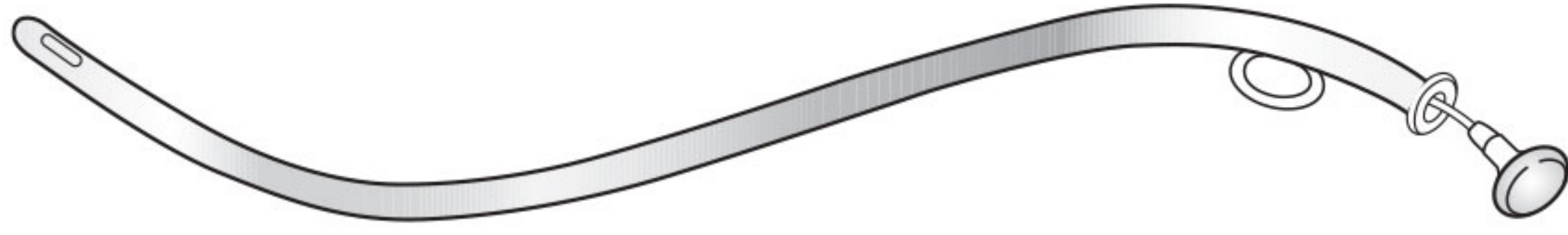

Code	Description
FST-3-400	8 E.G.
FST-3-401	10 E.G.

## Catheter

Oval, solid end, chromium plated



Code	Description
FST-3-402	165mm long

## Catheter Introducer

457mm long



Code	Description
FST-3-403	Straight, 2mm ø
FST-3-404	Curved, 2mm ø

## Catheter Introducer



Code	Description
FST-3-405	Fine, 395mm long

## Catheter Introducer

Bulbous end, with eye in handle



Code	Description
FST-3-406	Curved, 2mm x 410mm long



**Catheter Introducer**

With eye in handle, curved



Code	Description
FST-3-410	2mm x 420mm long

**Catheter Introducer**

Fixed handle



Code	Description
FST-3-411	445mm long

**Catheter Introducer**



Code	Description
FST-3-412	400mm long

**Catheter Introducer**

410mm long



Code	Description
FST-3-413	410mm long



# Scissors

## Barnes Episiotomy Scissors

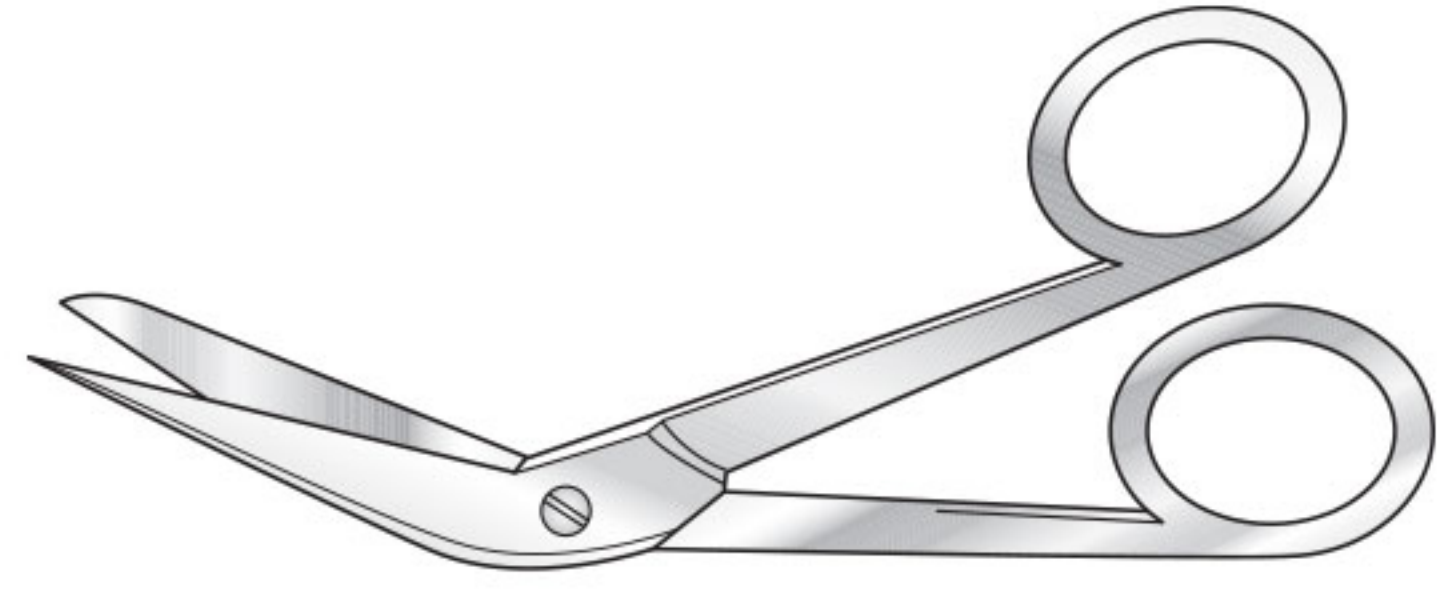

Code	Description
FST-3-420	127mm long

## Braun Stadler Episiotomy Scissors

Matt finish

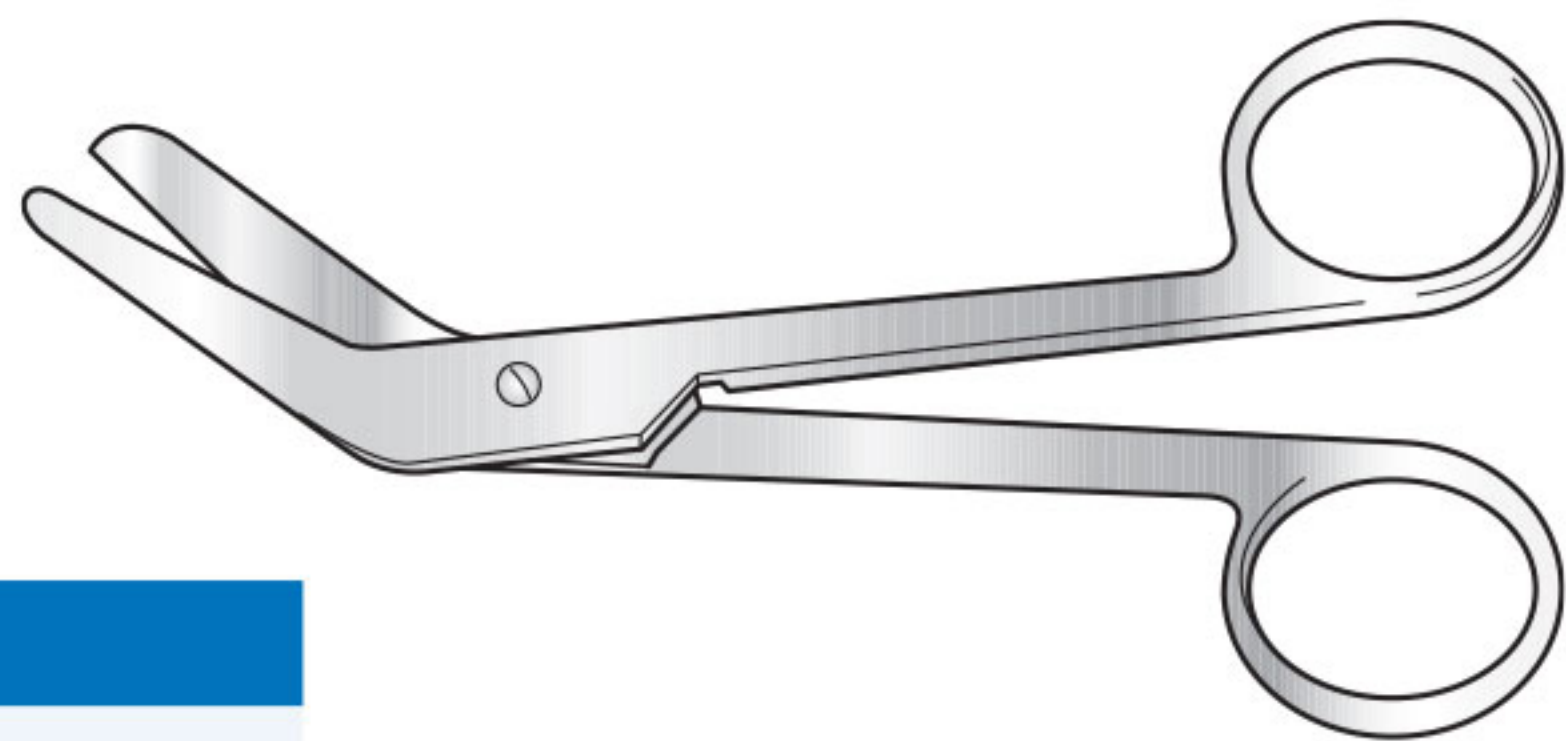

Code	Description
FST-3-422	140mm long
FST-3-423	222mm long

## Vant Episiotomy Scissors

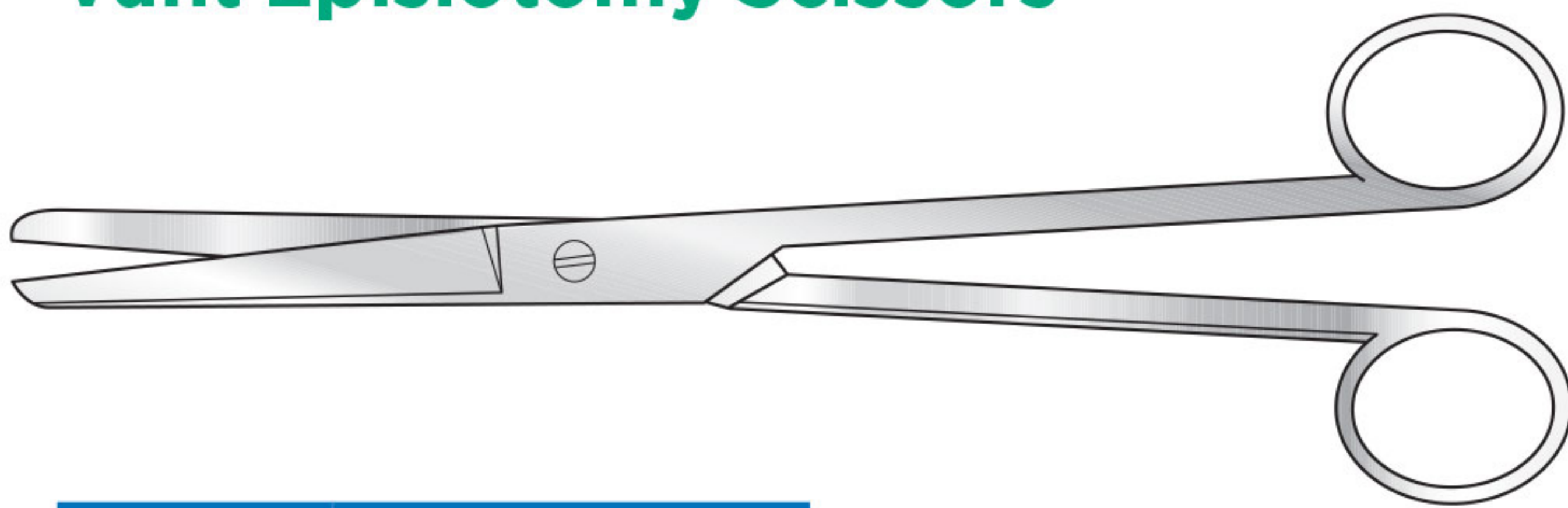

Code	Description
FST-3-425	76mm blades, 241mm long

## Busch Umbilical Scissors

Matt finish

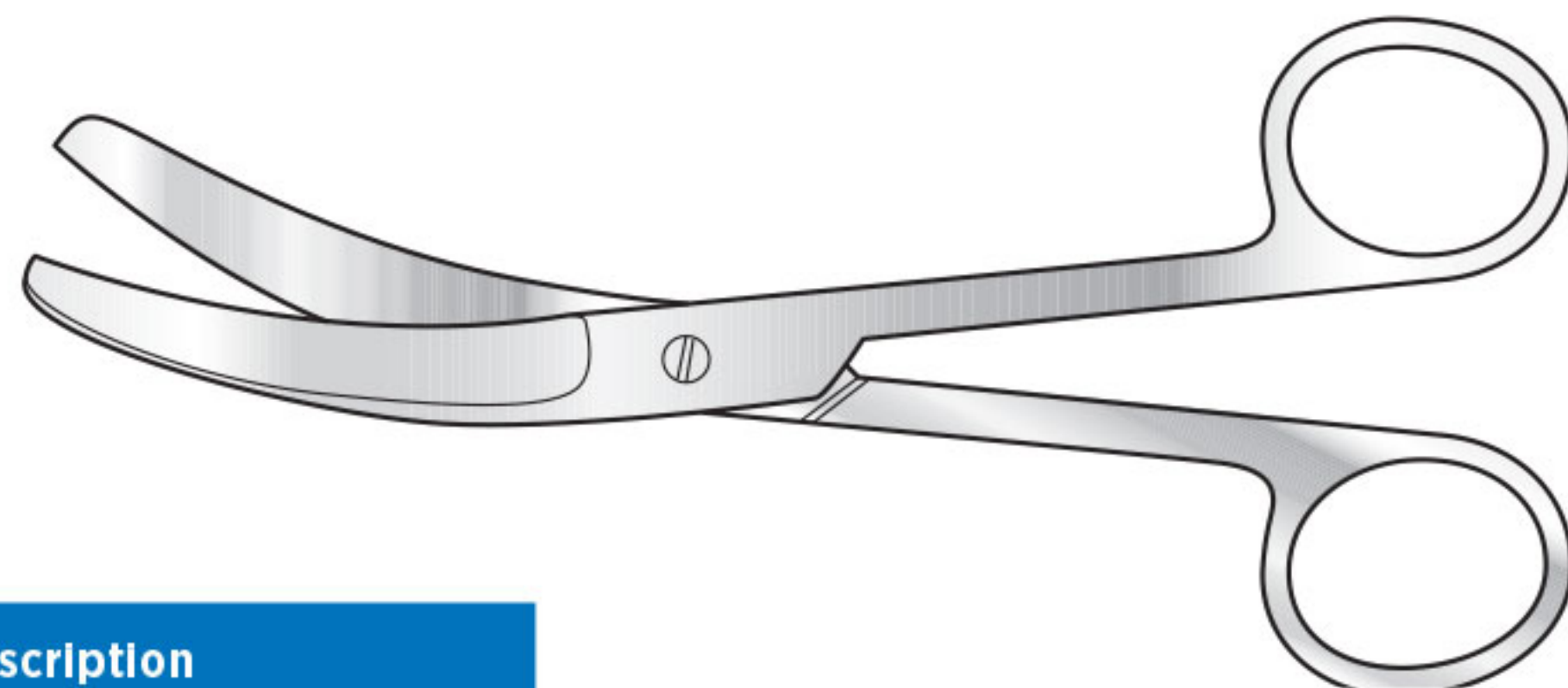

Code	Description
FST-3-427	160mm long

## Umbilical Scissors

American pattern

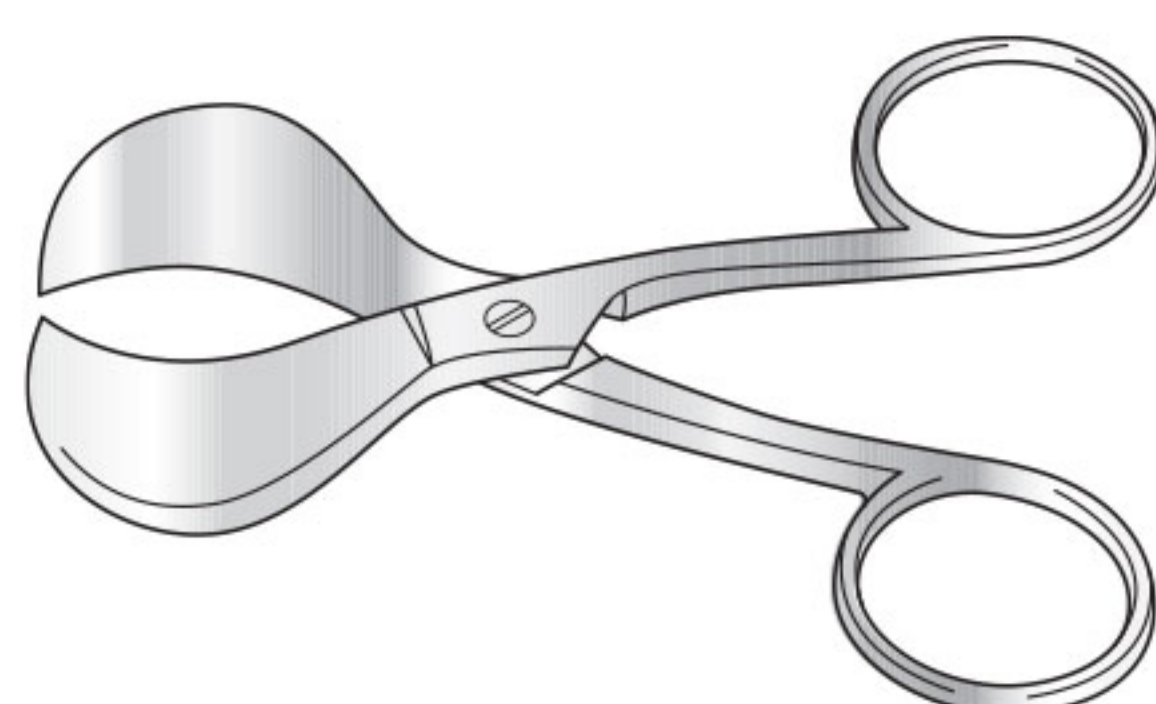

Code	Description
FST-3-428	102mm long

## Simms Uterine Scissors

Curved, tungsten carbide, with two gold bows

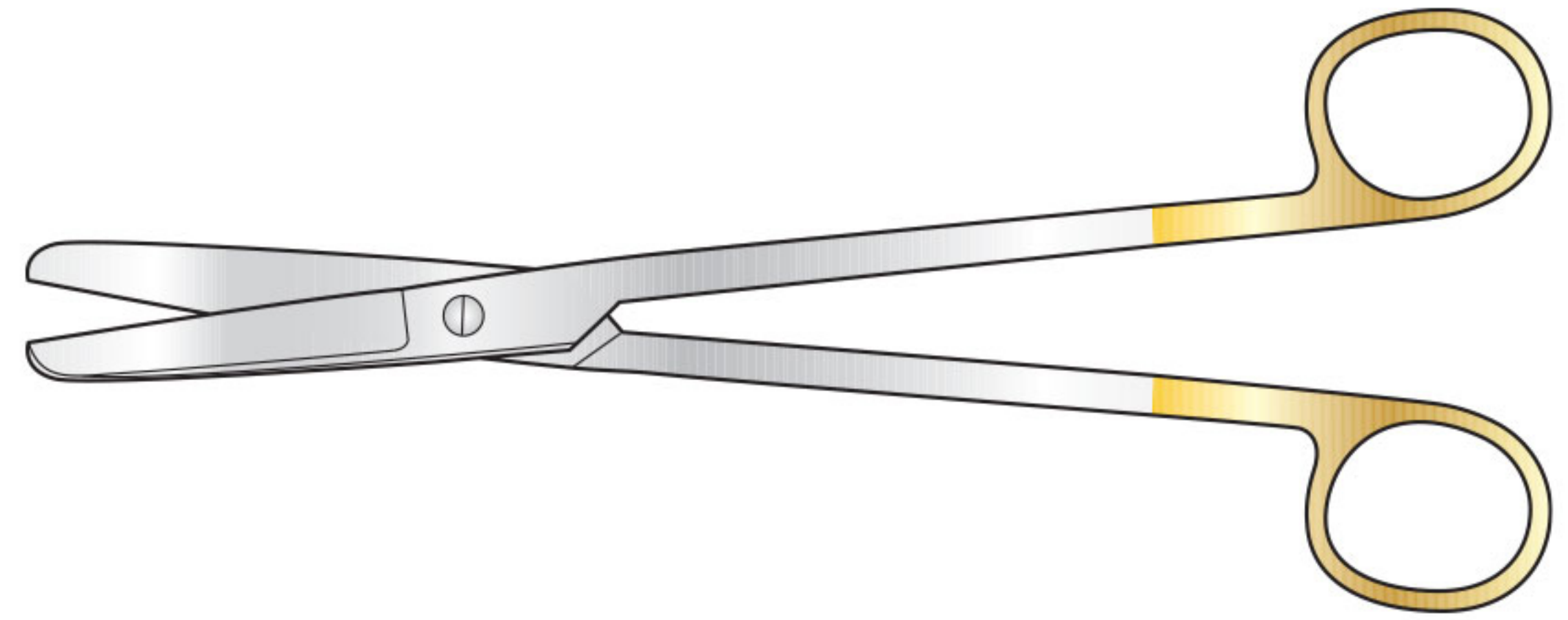

Code	Description
FST-3-421	200mm long

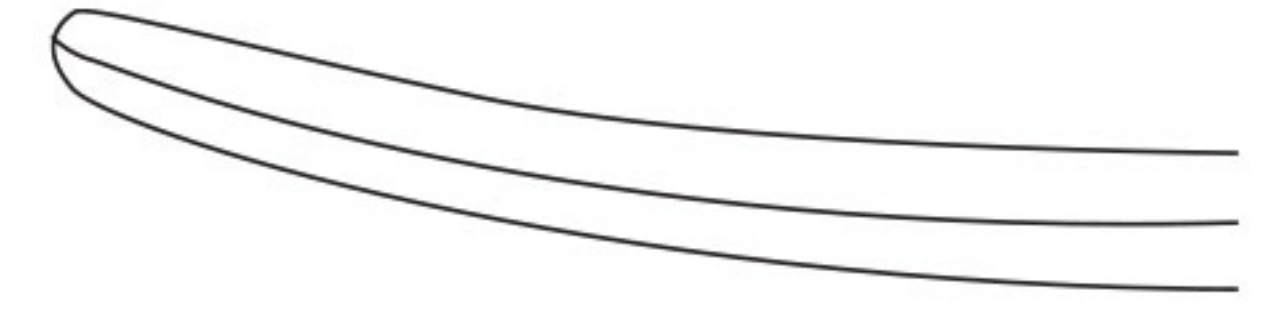

## Dubois Uterine Scissors

Matt finish

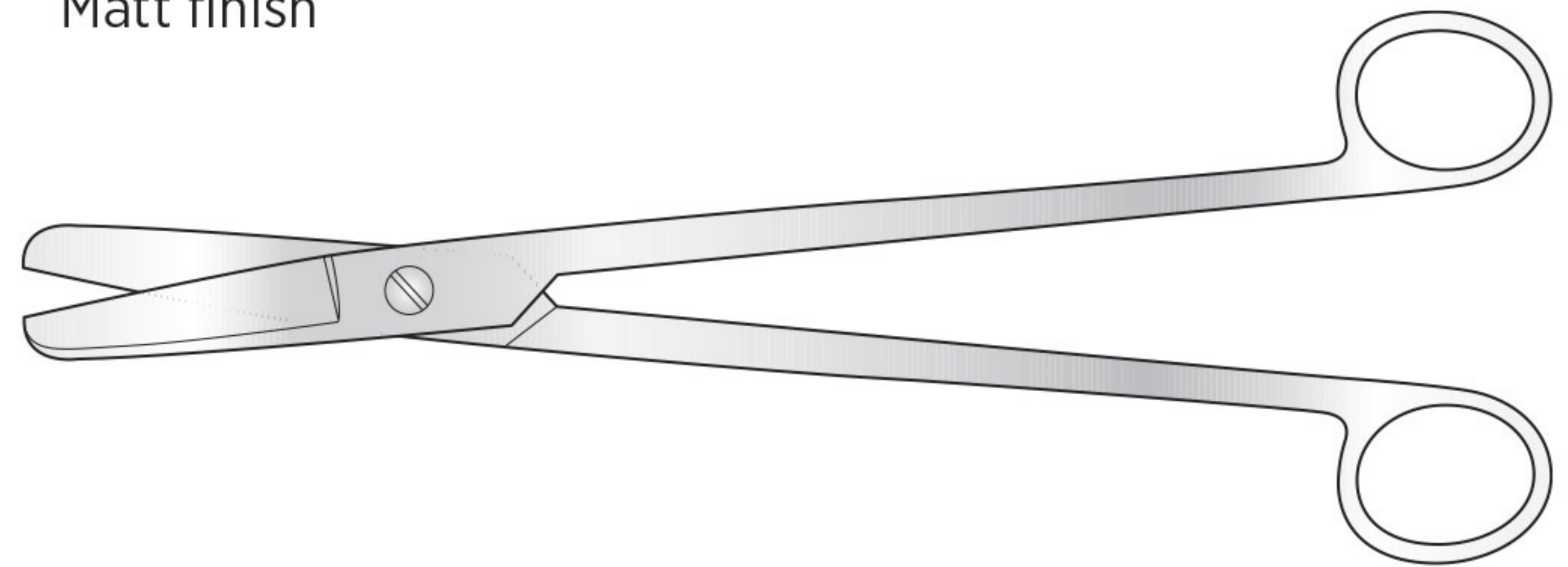

Code	Description
FST-3-424	270mm long

## Uterine Scissors

Curved on flat

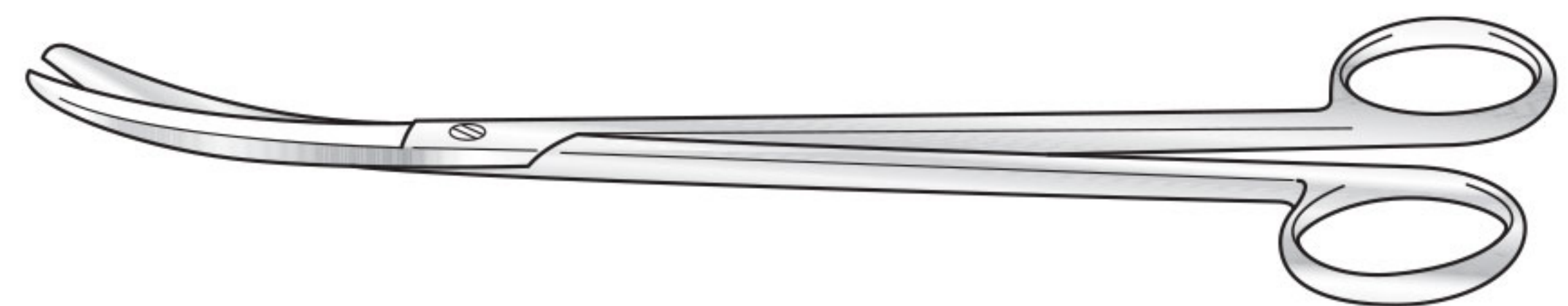

Code	Description
FST-3-426	203mm long

## Uterine Scissors

Angled on flat

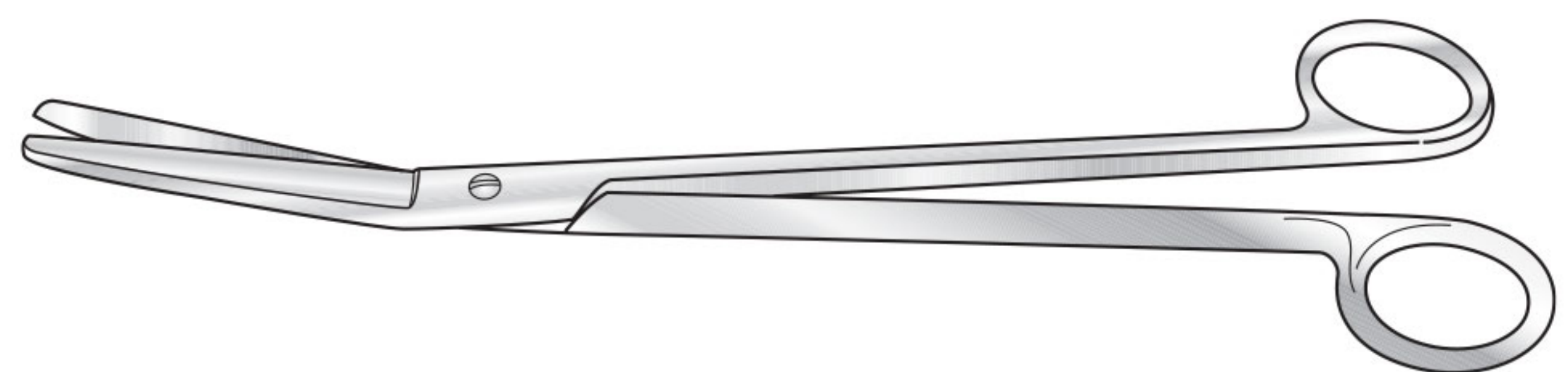

Code	Description
FST-3-429	230mm long



## Parametrium Scissors

225mm long

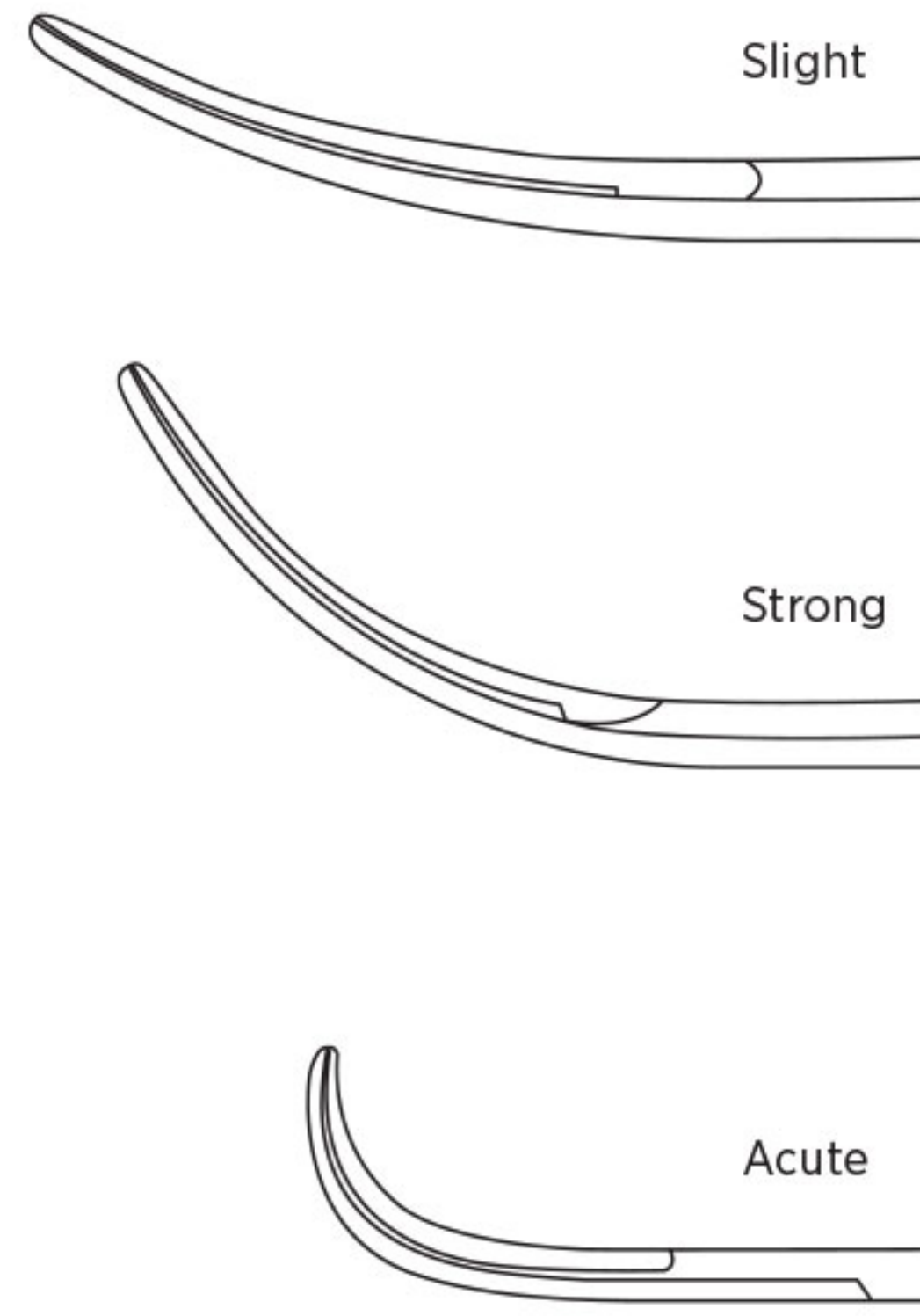
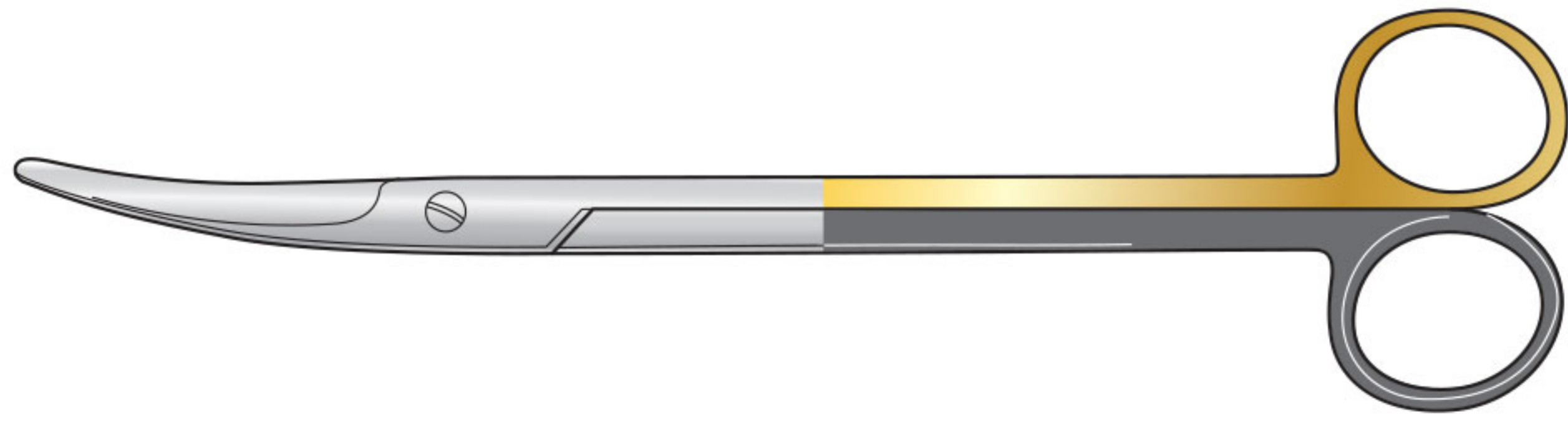

**Tungsten carbide, standard, with two gold bows**

Code	Description
FST-3-440	Slight curve
FST-3-441	Strong curve
FST-3-442	Acute curve

**Tungsten carbide, supercut, with one gold and one black bow**

Code	Description
FST-3-443	Slight curve
FST-3-444	Strong curve
FST-3-445	Acute curve

## Miscellaneous

### Bonney Myomectomy Clamp

With 51mm jaws, screw joint

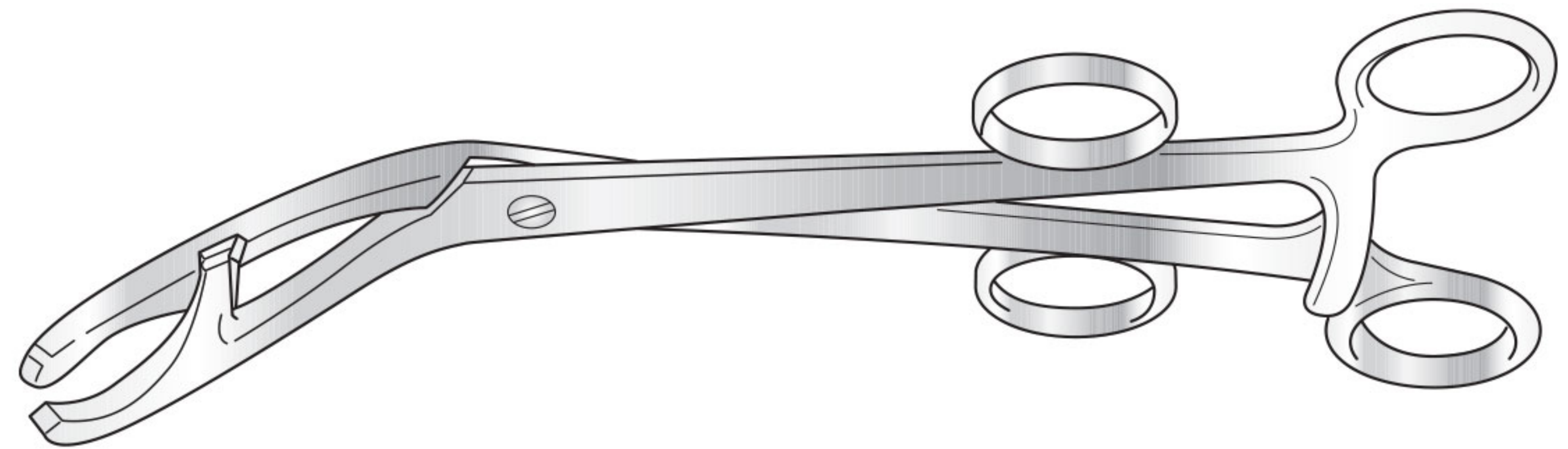

Code	Description
FST-3-446	267mm long

### Sims Vaginal Depressor

Double ended

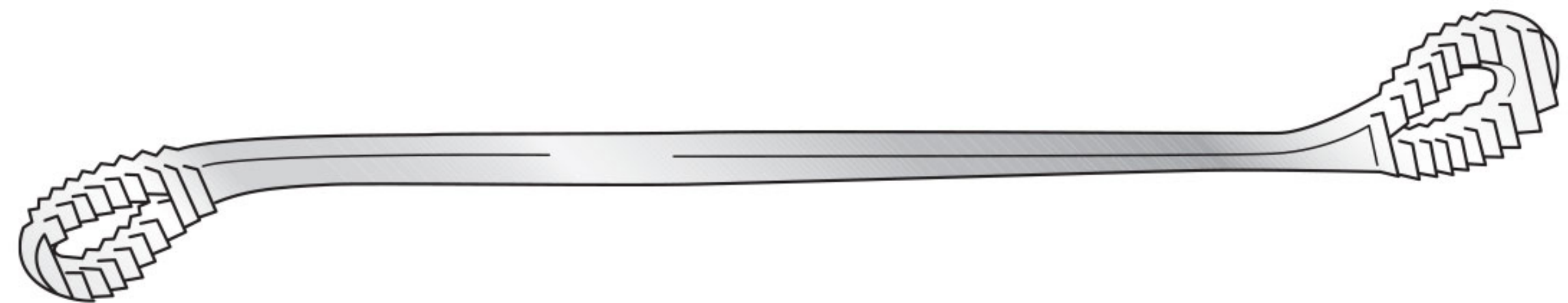

Code	Description
FST-3-447	260mm long

### Spackman Uterine Cannula

Chrome plated, 360mm long

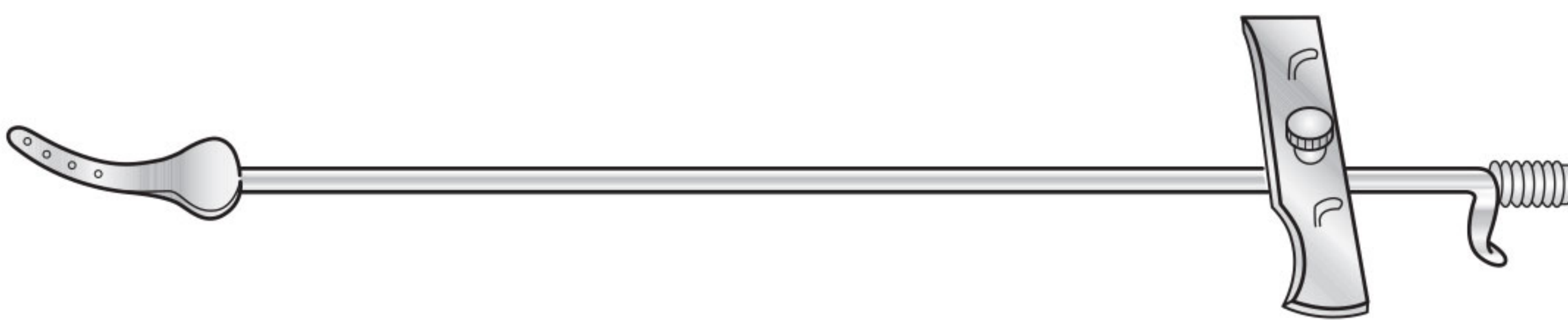

Code	Description
FST-3-448	12 F.G. with rubber cone
FST-3-449	14 F.G. with metal cone
FST-3-450	14 F.G. with rubber cone
FST-3-451	18 F.G. with metal cone
FST-3-452	18 F.G. with rubber cone

### Doyen Myoma Screw Large

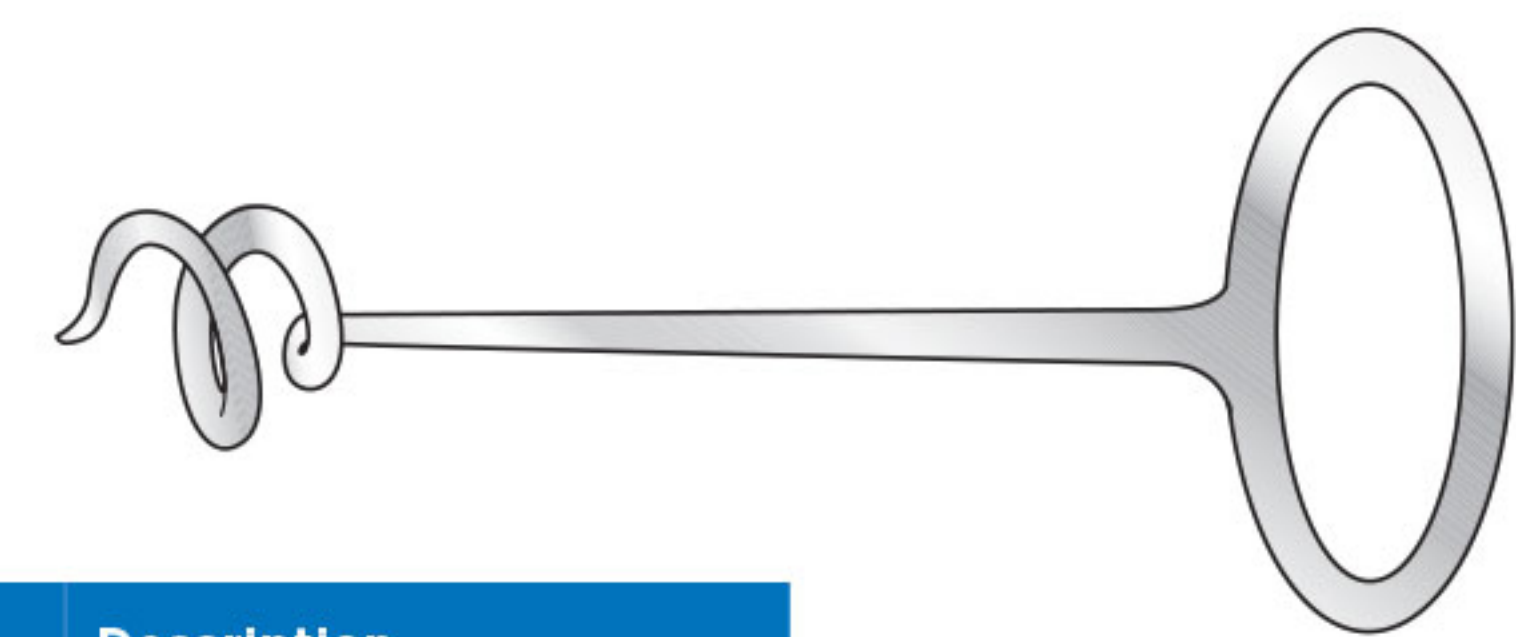

Code	Description
FST-3-453	178mm long

### Doyen Myoma Screw Small

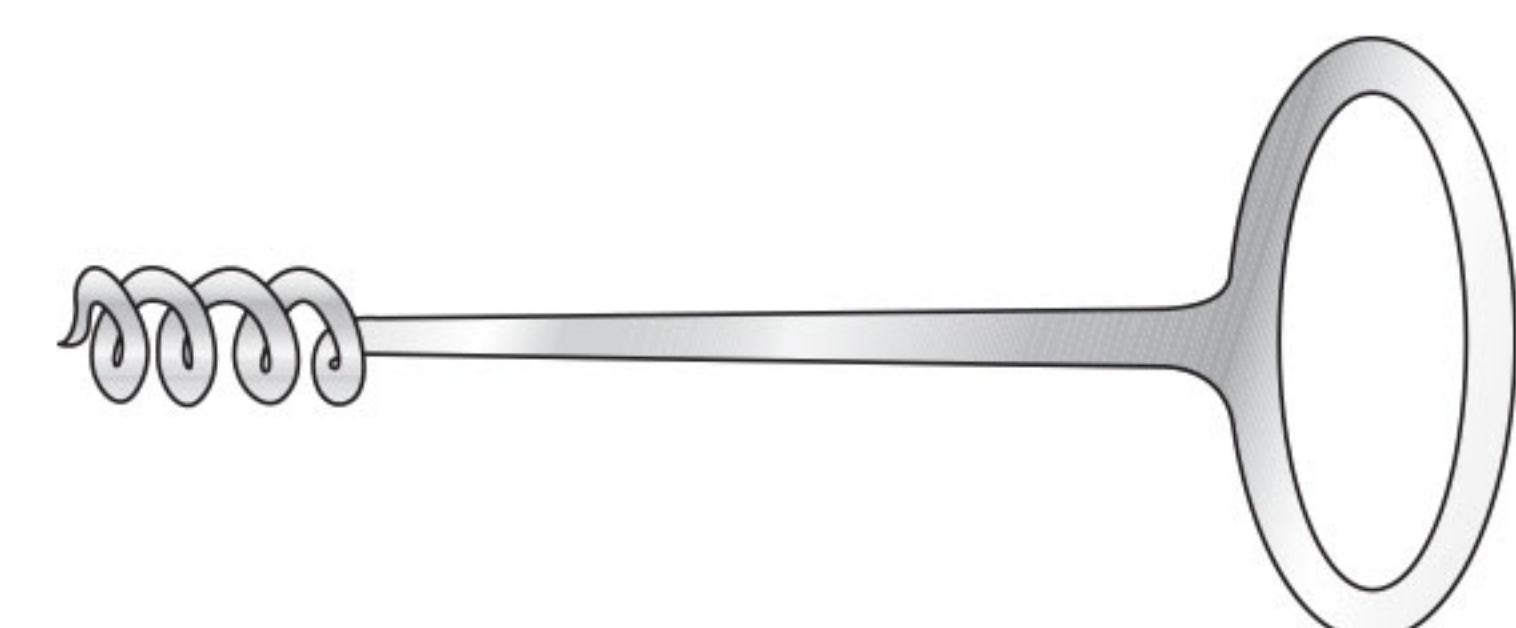

Code	Description
FST-3-454	178mm long



# Dilators and Sounds

## Galabin Uterine Sound

Calibrated 4-24, bright finish

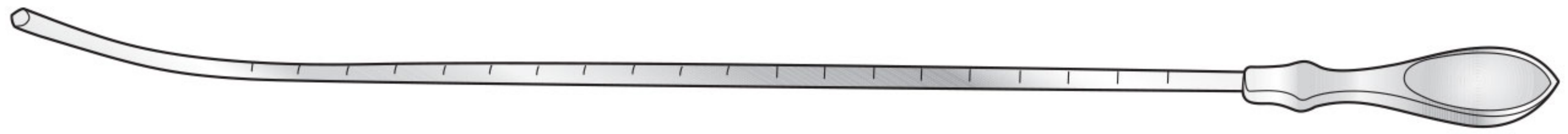

Code	Description
FST-3-470	305mm long

## Sims Uterine Sound

Calibrated 4-24, bright finish

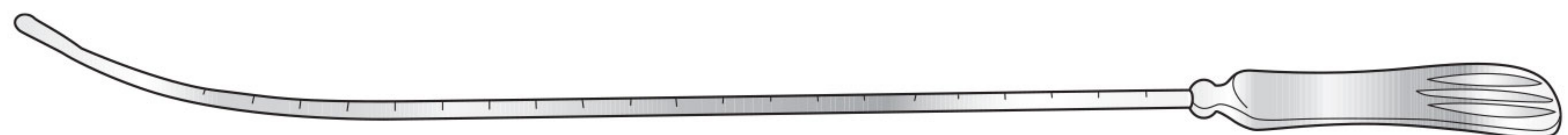

Code	Description
FST-3-471	320mm long

## Umbilical Dilator



Code	Description
FST-3-472	95mm long

## Hegar Cervix Dilator

Single ended, 185mm long



Code	Description
FST-3-473	1mm ø
FST-3-474	2mm ø
FST-3-475	3mm ø
FST-3-476	4mm ø
FST-3-477	5mm ø
FST-3-478	6mm ø
FST-3-479	7mm ø
FST-3-480	8mm ø
FST-3-481	9mm ø

Code	Description
FST-3-482	10mm ø
FST-3-483	11mm ø
FST-3-484	12mm ø
FST-3-485	13mm ø
FST-3-486	14mm ø
FST-3-487	15mm ø
FST-3-488	16mm ø
FST-3-489	17mm ø

## Hawkin Ambler Cervix Dilators

Conical, 171mm long



Code	Description
FST-3-490	Set of 12
FST-3-491	Size 3 - 6mm
FST-3-492	Size 4 - 7mm
FST-3-493	Size 5 - 8mm
FST-3-494	Size 6 - 9mm
FST-3-495	Size 7 - 10mm
FST-3-496	Size 8 - 11mm

Code	Description
FST-3-497	Size 9 - 12mm
FST-3-498	Size 10 - 13mm
FST-3-499	Size 11 - 14mm
FST-3-500	Size 12 - 15mm
FST-3-501	Size 13 - 16mm
FST-3-502	Size 14 - 17mm

## Hegar Cervix Dilator

Double ended, 200mm long

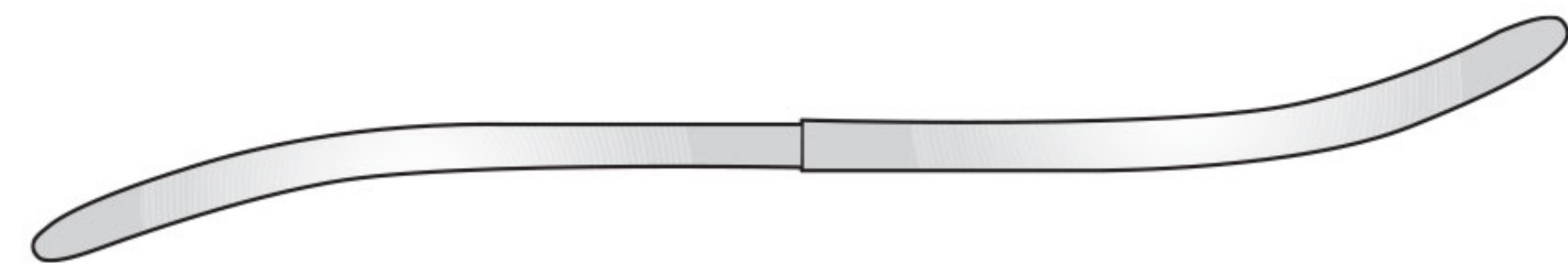

Code	Description
FST-3-503	Set of 8: from sizes 1 and 2mm to 15 and 16mm
FST-3-504	1 and 2mm ø
FST-3-505	3 and 4mm ø
FST-3-506	5 and 6mm ø
FST-3-507	7 and 8mm ø

Code	Description
FST-3-508	9 and 10mm ø
FST-3-509	11 and 12mm ø
FST-3-510	13 and 14mm ø
FST-3-511	15 and 16mm ø
FST-3-512	17 and 18mm ø





 Address: P.O Box 2953, 6 Awan Street Ugoki  
Road, Shahab Pura Sialkot - Pakistan

 Phone: +92 52 325 7510

 Phone: +92 52 324 1879

 Email: [info@fstinternational.com](mailto:info@fstinternational.com)

 website: [www.fstinternational.com](http://www.fstinternational.com)



独立行政法人 医薬品医療機器総合機構  
Pharmaceuticals and Medical Devices Agency