

FST International

ULTIMATE CHOICE IN QUALITY INSTRUMENTS



Diathermy/Bipolar



Diathermy/ Bipolar

1	Diathermy Scissors	03
2	Diathermy Forceps	03
3	Bipolar Forceps	04
4	Handles, Needles and Blades	05
5	Leads	06
6	Quivers	06

Turner Warwick Diathermy Scissors

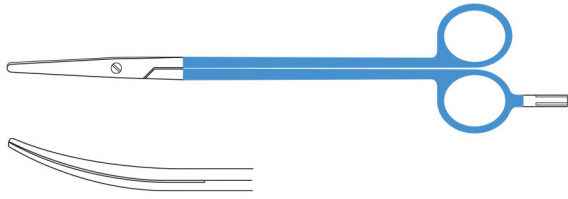

Straight

Code	Description
FST-1-101	190mm long
FST-1-102	230mm long
FST-1-103	250mm long

Curved

Code	Description
FST-1-104	190mm long
FST-1-105	230mm long
FST-1-106	250mm long

Riches Artery Forceps

Screw joint, curved

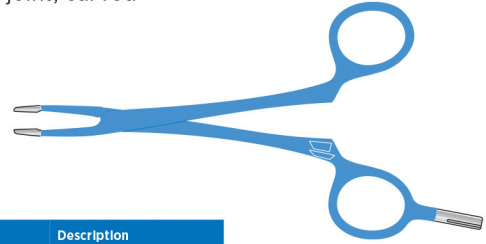

Code	Description
FST-1-111	127mm long
FST-1-112	152mm long
FST-1-113	178mm long
FST-1-114	185mm long
FST-1-115	228mm long

Adson Forceps

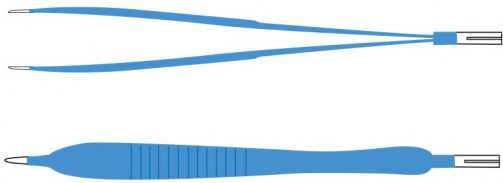

Code	Description
FST-1-120	152mm long

Wilson Hey Artery Forceps

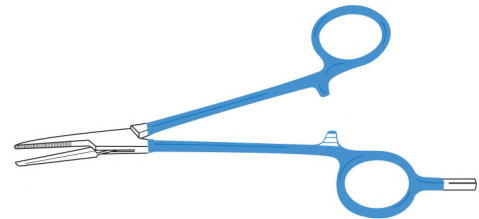

Straight

Code	Description
FST-1-125	152mm long
FST-1-126	178mm long
FST-1-127	185mm long
FST-1-128	228mm long

Curved

Code	Description
FST-1-129	152mm long
FST-1-130	178mm long
FST-1-131	185mm long
FST-1-132	228mm long

Dissecting Forceps



Serrated

Code	Description
FST-1-138	152mm long
FST-1-139	178mm long
FST-1-140	203mm long
FST-1-141	228mm long
FST-1-142	254mm long

1-2 teeth

Code	Description
FST-1-143	152mm long
FST-1-144	178mm long
FST-1-145	203mm long
FST-1-146	228mm long
FST-1-147	254mm long

Bipolar Forceps

Bipolar Forceps

Straight

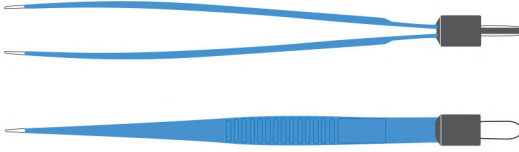

Fine tip

Code	Description
FST-1-160	101mm long
FST-1-161	127mm long
FST-1-162	152mm long
FST-1-163	178mm long
FST-1-164	185mm long

Medium tip

Code	Description
FST-1-166	101mm long
FST-1-167	127mm long
FST-1-168	152mm long
FST-1-169	178mm long
FST-1-170	185mm long

Heavy tip

Code	Description
FST-1-171	101mm long
FST-1-172	127mm long
FST-1-173	152mm long
FST-1-174	178mm long
FST-1-175	185mm long

Bipolar Forceps

Angled

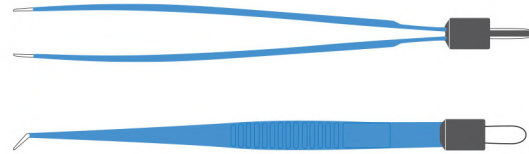

Fine tip

Code	Description
FST-1-180	101mm long
FST-1-181	127mm long
FST-1-182	152mm long
FST-1-183	178mm long
FST-1-184	185mm long

Medium tip

Code	Description
FST-1-185	101mm long
FST-1-186	127mm long
FST-1-187	152mm long
FST-1-188	178mm long
FST-1-189	185mm long

Heavy tip

Code	Description
FST-1-190	101mm long
FST-1-191	127mm long
FST-1-192	152mm long
FST-1-193	178mm long
FST-1-194	185mm long

Adson Bipolar Forceps

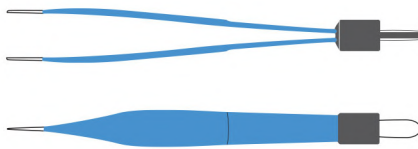

Code	Description
FST-1-200	152mm long

Monel Handle



Code	Description
FST-1-210	145mm long

Monel Blade

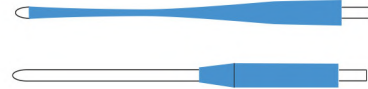

Code	Description
FST-1-215	Fully insulated
FST-1-216	Non-insulated

Needle Handles



Code
FST-1-221

Needles

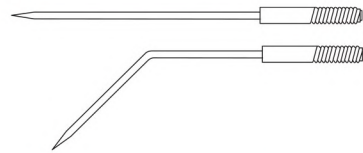

Straight

Code	Description
FST-1-227	Stout
FST-1-228	Medium

Angled

Code	Description
FST-1-229	Stout
FST-1-230	Medium

Abbey Diathermy Needle

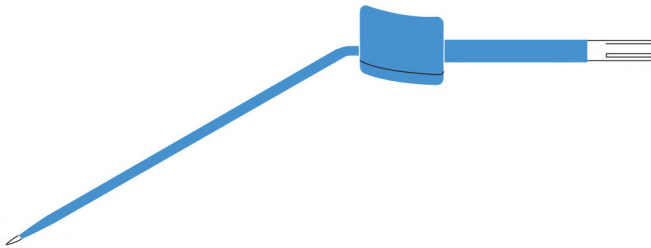

Code
FST-1-235

Diathermy Arm

With ball



Code	Description
FST-1-240	Curved
FST-1-241	Straight

Finger Switch Pencil

With spatula and 3 metre lead



Code
FST-1-246

Spatula Blade

For diathermy finger



Code
FST-1-252

Needle Point

For diathermy finger



Code
FST-1-258

Leads and Quivers

Leads

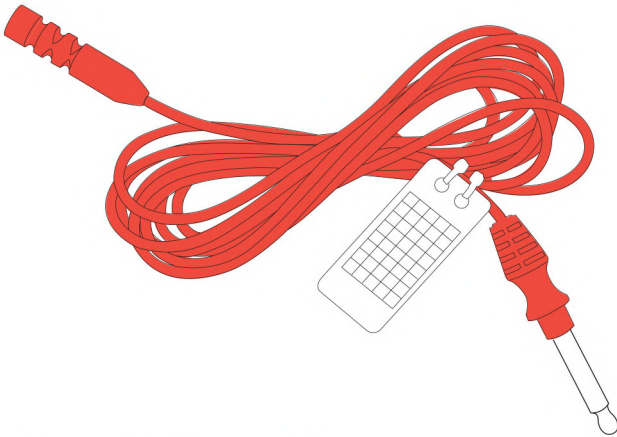

Code	Description
FST-1-270	4mm plug end
FST-1-271	8mm plug end

Bipolar Leads

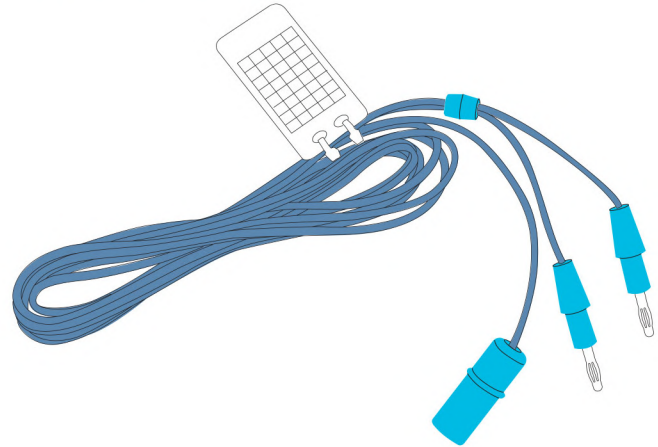

Code	Description
FST-1-277	Standard

Quiver

With hole in end, 232mm long

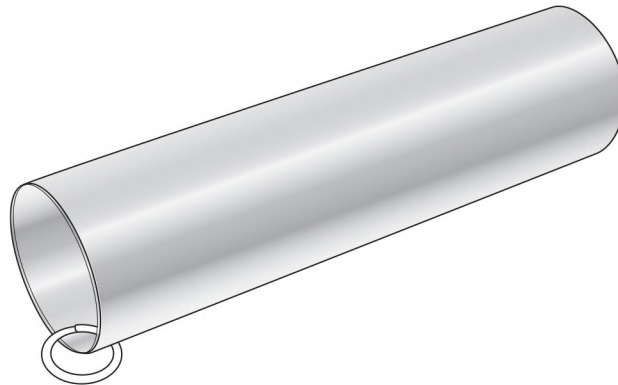

Code	Description
FST-1-283	Standard

Quiver

With hole in end, 232mm long

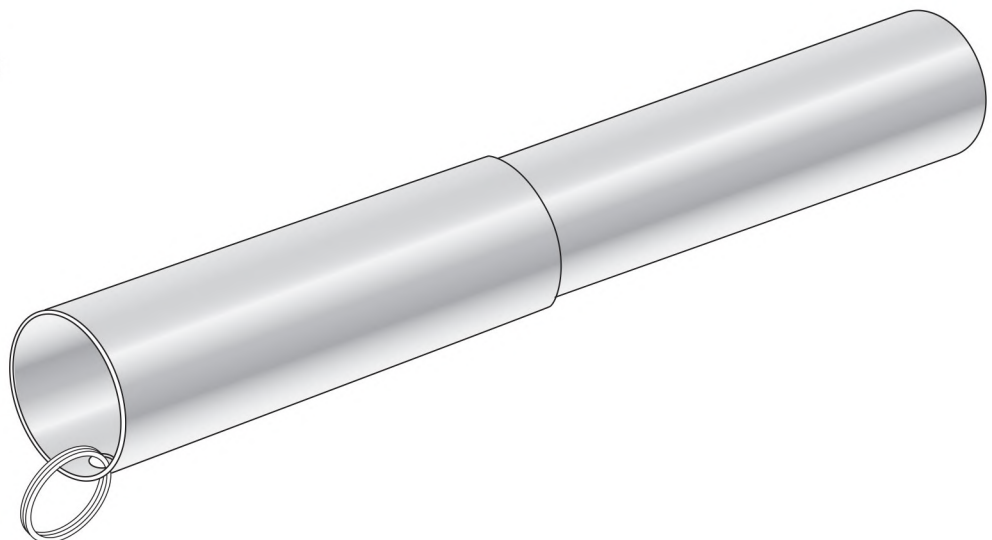



Code	Description
FST-1-289	Telescopic

CONTACT US



 Address: P.O Box 2953, 6 Awan Street Ugoki Road,
Shahab Pura Sialkot - Pakistan

 Phone: +92 52 325 7510

 Phone: +92 52 324 1879

 Email: info@fstinternational.com

 website: www.fstinternational.com



**ASK FOR
DETAILS CATALOGUE**

